

# Technische Daten Saunahaus Ella 70 de luxe

Wandaußenmaß: 395 x 366 cm

Bohlenstärke: 70 mm



Kontrolliert durch:

Achtung: Alle angegebenen Maße sind ca.-Maße!

# 3D-Darstellung und Grundriss Saunahaus Ella 70 de luxe

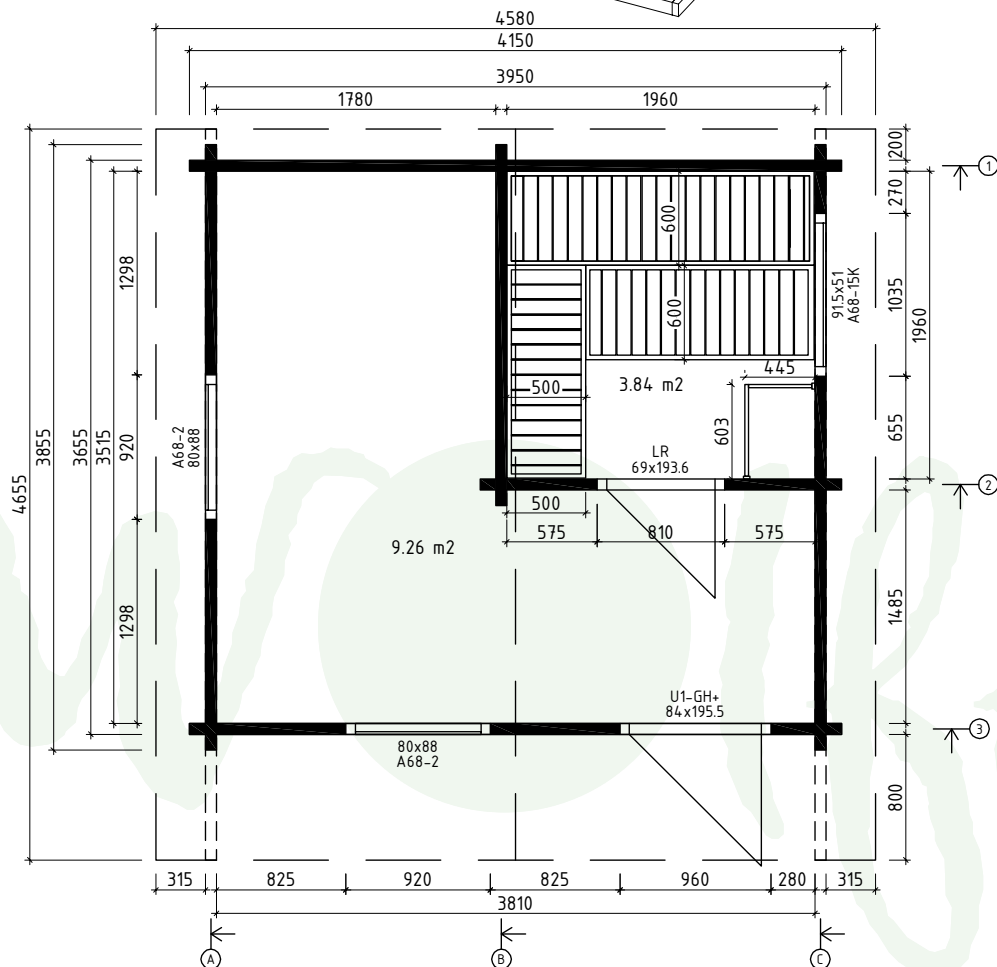
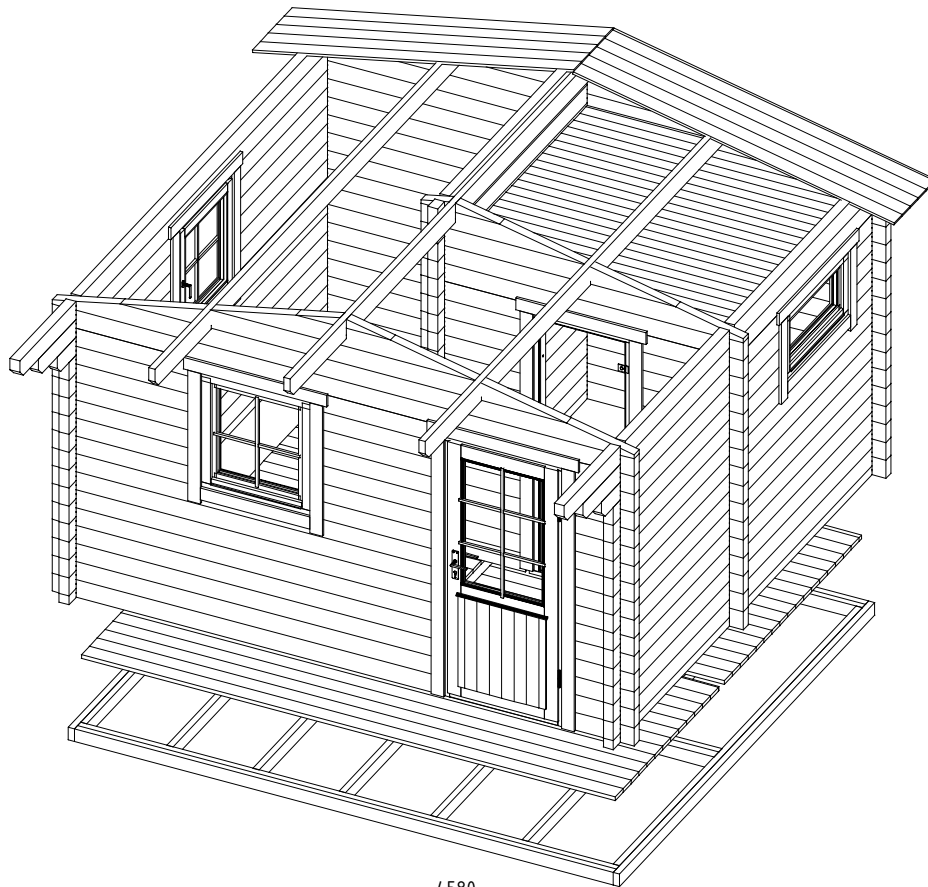





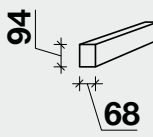
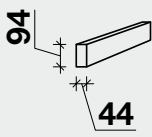
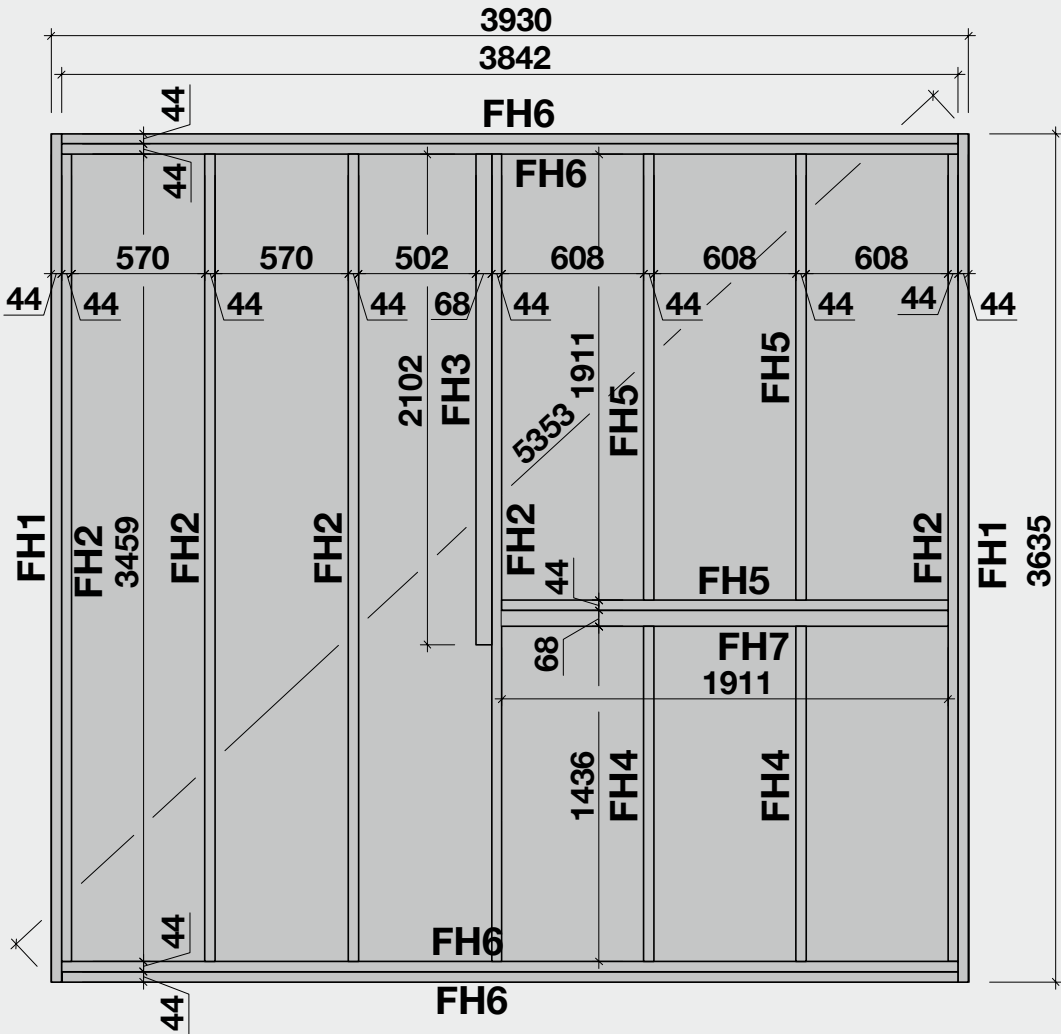

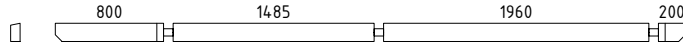
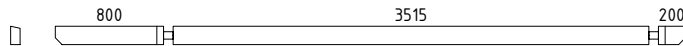
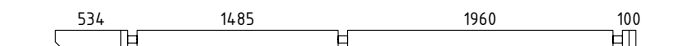
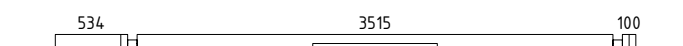
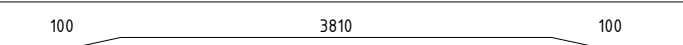

# Lagerholzplan und Fundamentplan Saunahaush Ella 70 de luxe

Wir empfehlen als Fundament für Ihr Gartenhaus eine vollflächig, festgegründete gepflasterte oder betonierte Fläche.  
Wahlweise ist auch ein Punkt- oder Streifenfundament möglich.

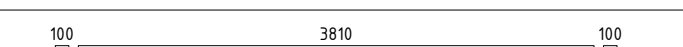

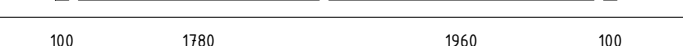
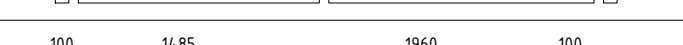
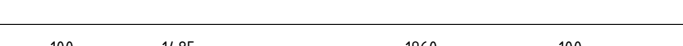
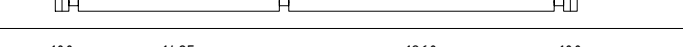
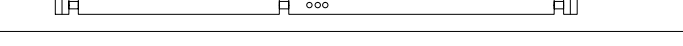
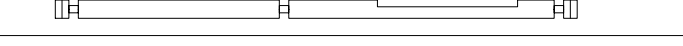
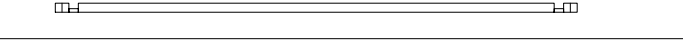
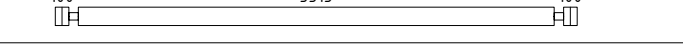
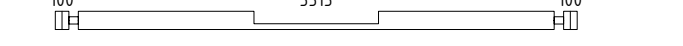
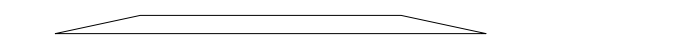
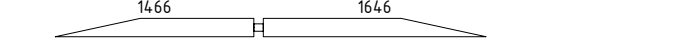
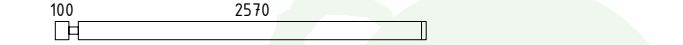

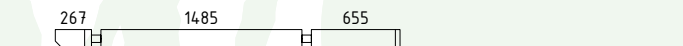

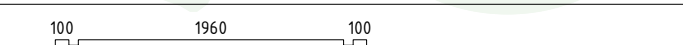





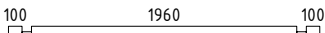
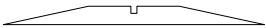
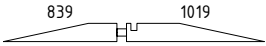
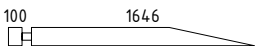
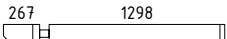
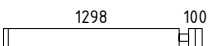
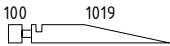
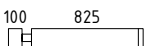

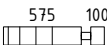
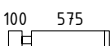

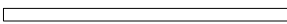

# Teileliste 1

## Saunahaush Ella 70 de luxe

Pos		Stck.	Profil (mm)	Länge (mm)
001		1	70x135	4655
002		1	70x135	4655
003		1	70x135	4289
004		1	70x135	4289
005		1	70x135	4150
006		1	70x135	4150
007		1	70x135	4150
008		14	70x135	4150
009		2	70x135	4150
010		1	70x68	3855
011		8	70x135	3855
012		1	70x135	3855
013		1	70x135	3855
014		1	70x68	3855
015		7	70x135	3855
016		1	70x135	3855
017		1	70x135	3182
018		1	70x135	3182
019		7	70x135	2740
020		1	70x135	2740
021		1	70x135	2547
022		3	70x135	2380
023		1	70x135	2300
024		19	70x135	2300
025		1	70x128	2300

# Teileliste 2

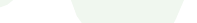
## Saunahaush Ella 70 de luxe

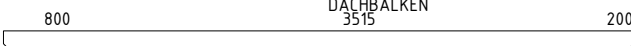
Pos		Stck	Profil (mm)	Länge (mm)
026		1	70x68	2300
027		1	70x135	1927
028		1	70x135	1927
029		1	70x135	1816
030		1	70x135	1635
031		11	70x135	1468
032		1	70x135	1189
033		7	70x135	995
034		7	70x135	825
035		14	70x135	745
036		16	70x135	745
037		15	70x135	450
038		4	70x135	440
039		4	70x68	314
040		1	70x68	314
041		1	70x68	203
FH3	FUNDAMENTHÖLZER (imprägniert) 	1	68x94	2102
FH7	FUNDAMENTHÖLZER (imprägniert) 	1	68x94	1911
FH6	FUNDAMENTHÖLZER (imprägniert) 	4	44x94	3842
FH1	FUNDAMENTHÖLZER (imprägniert) 	2	44x94	3635
FH2	FUNDAMENTHÖLZER (imprägniert) 	5	44x94	3459
FH5	FUNDAMENTHÖLZER (imprägniert) 	3	44x94	1911
FH4	FUNDAMENTHÖLZER (imprägniert) 	2	44x94	1436
HS1	HOLZSCHWELLE (unter der Saunatur) 	✓ 1	75x28	750
DB1	DACHBALKEN 800  200	1	44x145	4655











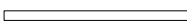
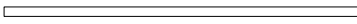

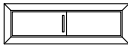
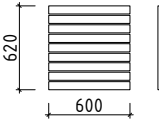

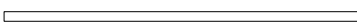

# Teileliste 3

## Saunahaush Ella 70 de luxe

Pos		Stck.	Profil (mm)	Länge (mm)
DB2		2	44x145	4655
	DACHBRETTER	84+1	113x18	2340
	FUSSBODENBRETTER	14+1	113x28	3805
	FUSSBODENBRETTER	18	113x28	1955
	FUSSBODENBRETTER	18	113x28	1775
	ABDECKLEISTEN	✓	15x28	28,0 lfm
	FUSSBODENLEISTE	✓	14x55	23,0 lfm
G1-1	GIEBELBRETTER 120X18  12,1°	✓	120x18	2420
G5-1	GIEBELDECKLEISTE 58X18	✓	58x18	2420
T2-1	TRAUFBRETTER 90X18		90x18	4655
T4-1	TRAUFELEISTE 40x18	✓	40x18	10,0 lfm
GS	Giebelsegment	2		
TL3-1	T-LEISTE 70	2	70x45	490
TL3-2	T-LEISTE 70	2	70x45	760
TL3-3	T-LEISTE 70	2	70x45	895
TL3-4	T-LEISTE 70	4	70x45	1975
	SAUNABANK /Espe/ 60 cm/50 cm	2	ca 600x90	1955
		1	ca 500x90	1355
	RÜCKLEHNE /Espe/	2	ca 250x39	1860
	BÄNKE ZWISCHENSTÜCK /Espe/	1	ca 350x39	1955
	KOPFSTÜTZE /Espe/	2	ca 444x300	
	DECKENISOLATION	2 Elemente	ca 1950x975	

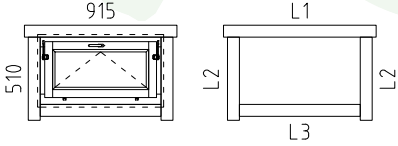

# Teileliste 4

## Saunahaus Ella 70 de luxe

Pos		Stck.	Profil (mm)	Länge (mm)
	TRÄGELEISTE FÜR SAUNABÄNKE 	3	ca 30x40	600
	TRÄGELEISTE FÜR SAUNABÄNKE 	2	ca 30x40	1200
	TRÄGELEISTE FÜR DECKENISOLATION  ✓	4	35x35	2000
	HEIZUNG UMBAU 		2 Elemente	
	LUFTSCHIEBER 	3		
	BODENROST /Fichte/ 	1	600x620	
	STÜTZPFOSTEN FÜR SAUNABÄNKE  ✓	1	44x68	500
	STÜTZPFOSTEN FÜR SAUNABÄNKE  ✓	2	44x68	1000
SH	Schlaghölzer 	3		
KL1	Gewindestange M8 	4	M8	2000
KL2	Gewindestange M8 	4	M8	258
	Mutter M8 U-Scheibe Ø25 	8	M8	
	Befestigungsmutter M8 	4	M8	
	Schlossschraube 70mm für Verbinden der Saunabänke 600+500mm in der Ecke	2	M8	
NG1	NÄGEL 2.5x50 Dachbretter 	504		
NG2	NÄGEL 2.5x60 Fussbodenbretter 	496		
SR01	SCHRAUBEN 3.0x30 Abdeckleiste, Fussbodenleiste Traufenleiste 40x18, Bänke Zwischenstück, Luftschieber 	140		
SR03	SCHRAUBEN 3.5x45 Giebelbretter, Traufenbretter Giebelsegment, Heizung Umbau, Fenster- und Türleisten 	184		
SR05	SCHRAUBEN 4.0x60 Trägleiste für Saunabänke, Rücklehne Trägleiste für Deckenisolation 	62		
SR11	SCHRAUBEN 5.0x100 Fundamenthölzer Stützpfosten für Saunabänke 	82		
	FENSTER 915x510  A68-15K L1 18x90 L=1155mm 2 Stck. L2 18x90 L=630mm 4 Stck. L3 18x90 L=915mm 2 Stck. ✓	1		

# Teileliste 5

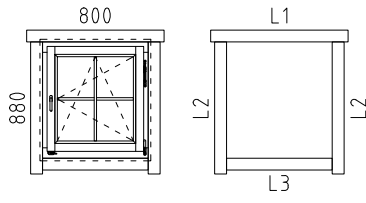
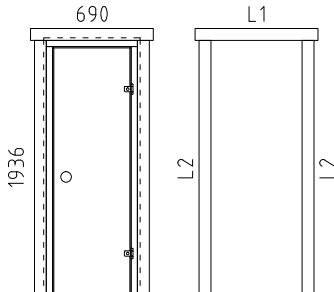
## Saunahaus Ella 70 de luxe

Pos		Stck.	Profil (mm)	Länge (mm)
	<b>FENSTER 800x880</b>   <p style="margin-left: 200px;">A68-2</p> <p style="margin-left: 200px;">L1 18x90 L=1040mm 2 Stck. L2 18x90 L=1000mm 4 Stck. L3 18x90 L=800mm 2 Stck. ✓</p>	2		
	<b>TÜR 690x1936</b>   <p style="margin-left: 200px;">LR</p> <p style="margin-left: 200px;">L1 18x90 L=930mm 2 Stck. L2 18x90 L=1935mm 4 Stck. ✓</p> <p style="margin-left: 200px;">DIN rechts</p>	1		
	<b>TÜR 840x1955</b>   <p style="margin-left: 200px;">U1-GH+</p> <p style="margin-left: 200px;">L1 18x90 L=1080mm 2 Stck. L2 18x90 L=1955mm 4 Stck. ✓</p> <p style="margin-left: 200px;">DIN rechts</p>	1		
	Dichtungsband für Deckenisolationselemente	✓	ca 8,0 lfdm	
<b>Achtung Hinweis:</b> <b>wir empfehlen die Stromverkabelung für den Elektro-Saunaofen vor Verlegung von den Fußbodenbrettern durchzuführen.</b>				
	✓ - bitte selber anpassen (falls nötig)!			



# Wandplan 1 und 2 Saunahaush Ella 70 de luxe

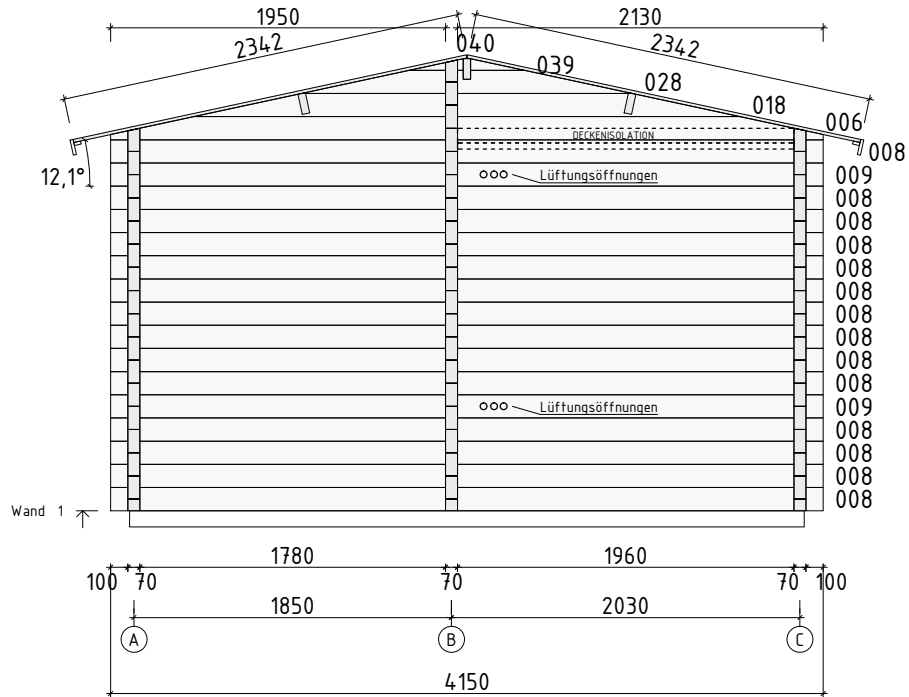
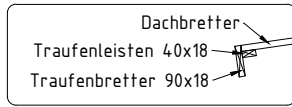

Die Bohlen mit Lüftungsöffnungen können je nach Bedarf höher oder niedriger eingesetzt werden. Bitte achten Sie darauf dass die Lüftungsöffnungen von innen nicht mit der Saunabank bedeckt werden!

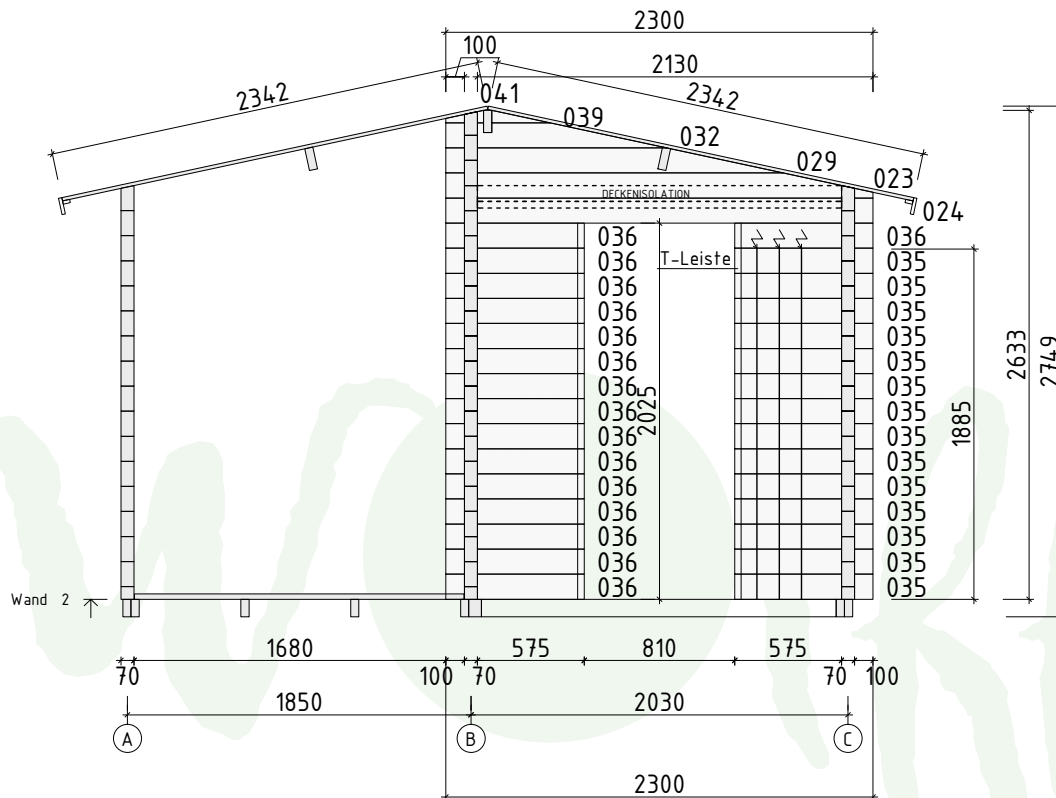

↘ -Bohrung für elektrische Kabel

# Wandplan 3

## Saunahaush Ella 70 de luxe

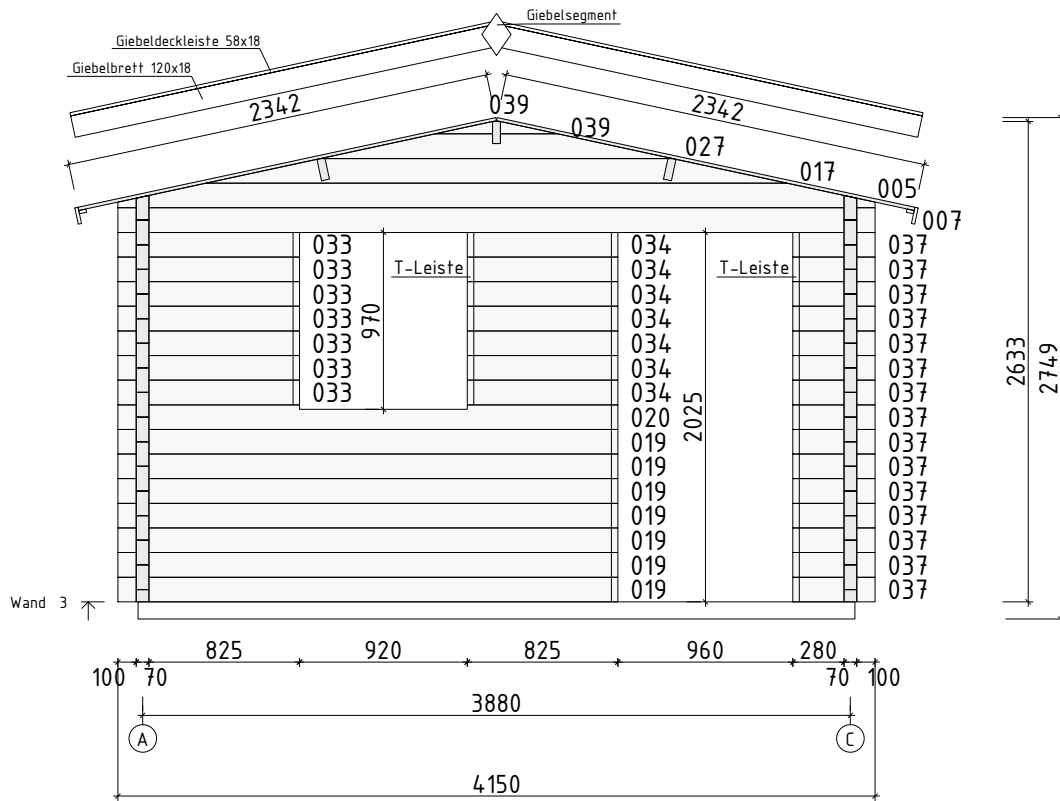

# Wandplan A und B Saunahaush Ella 70 de luxe

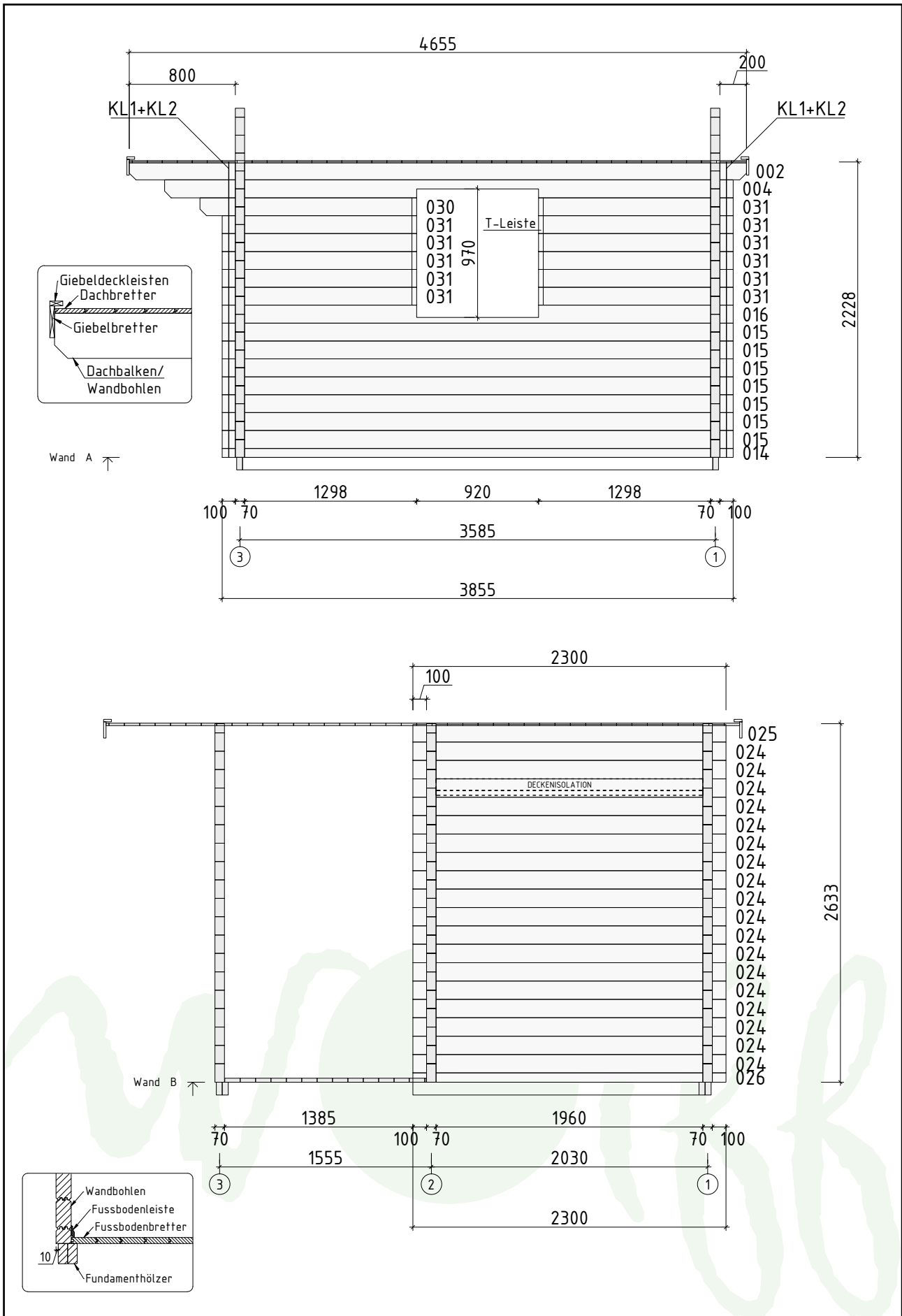

# Wandplan C

## Saunahaush Ella 70 de luxe

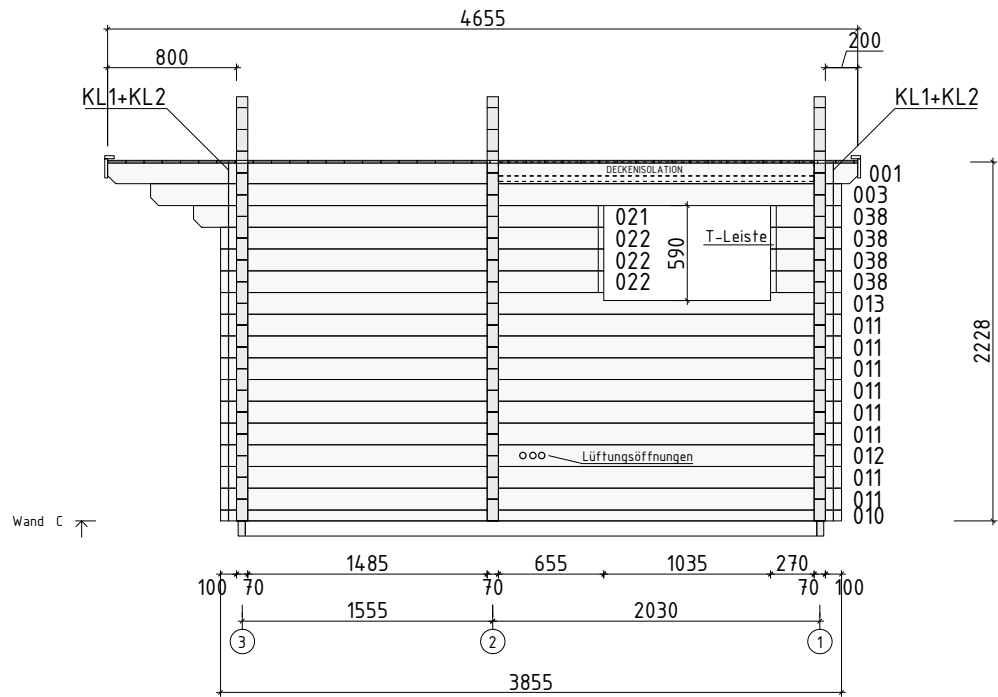

Die Bohlen mit Lüftungsöffnungen können je nach Bedarf höher oder niedriger eingesetzt werden. Bitte achten Sie darauf dass die Lüftungsöffnungen von innen nicht mit der Saunabank bedeckt werden!

# Detail / optional Saunahaus Ella 70 de luxe

Montageanleitung für T-Leisten / Installing the door and window supports / Tenderliistu paigaldusjuhend.

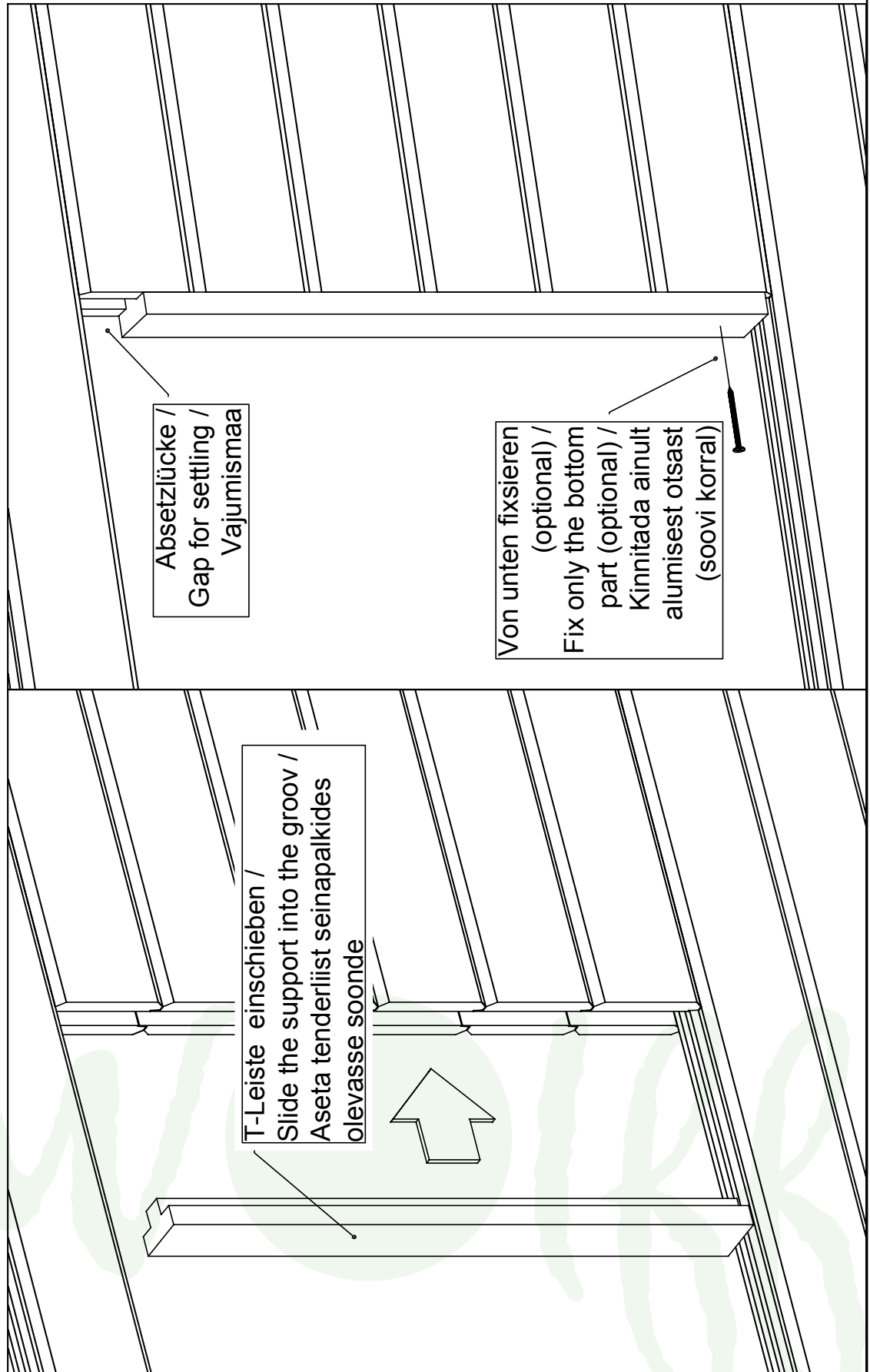

# Detail / optional

## Saunahaus Ella 70 de luxe

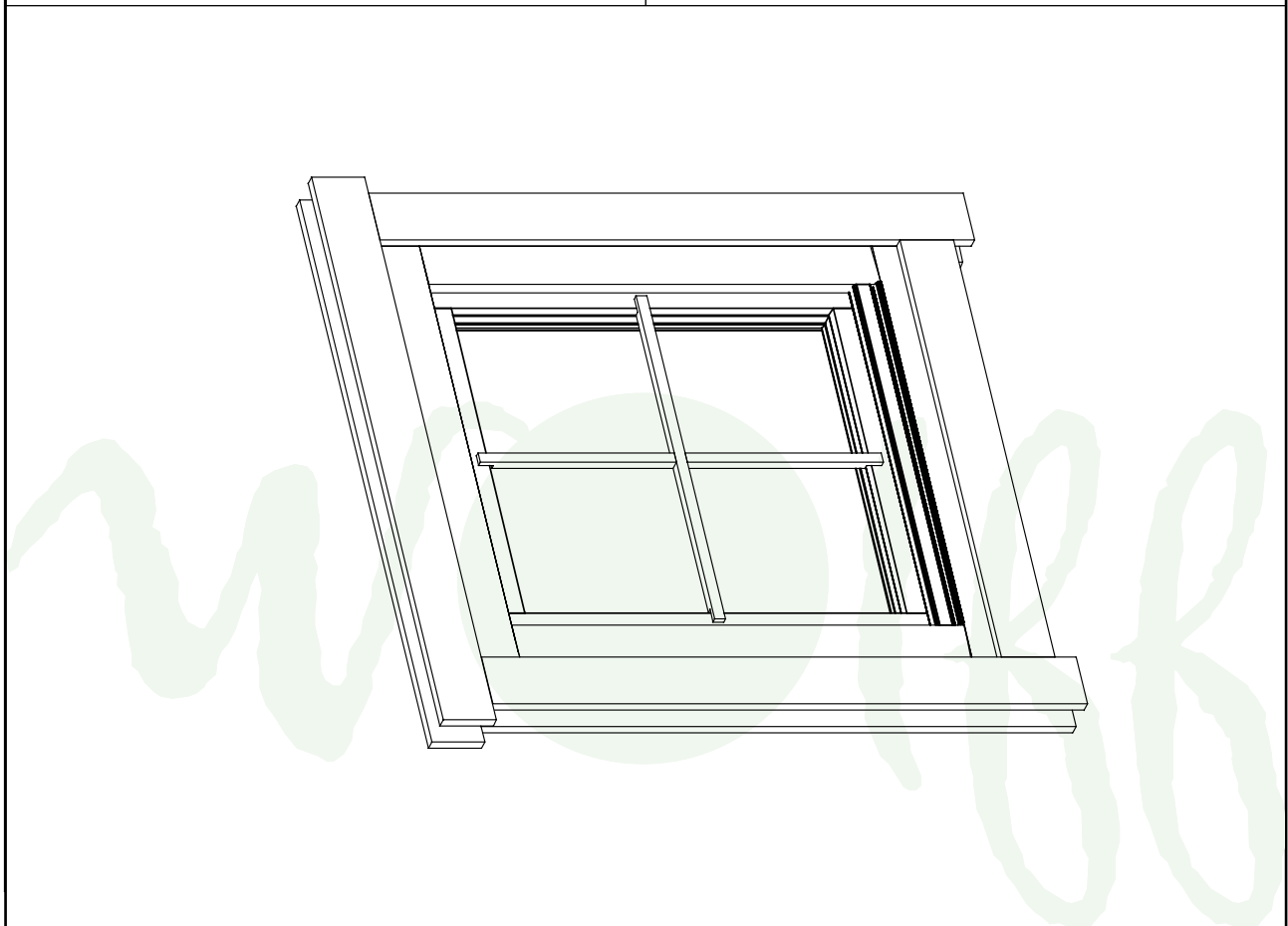
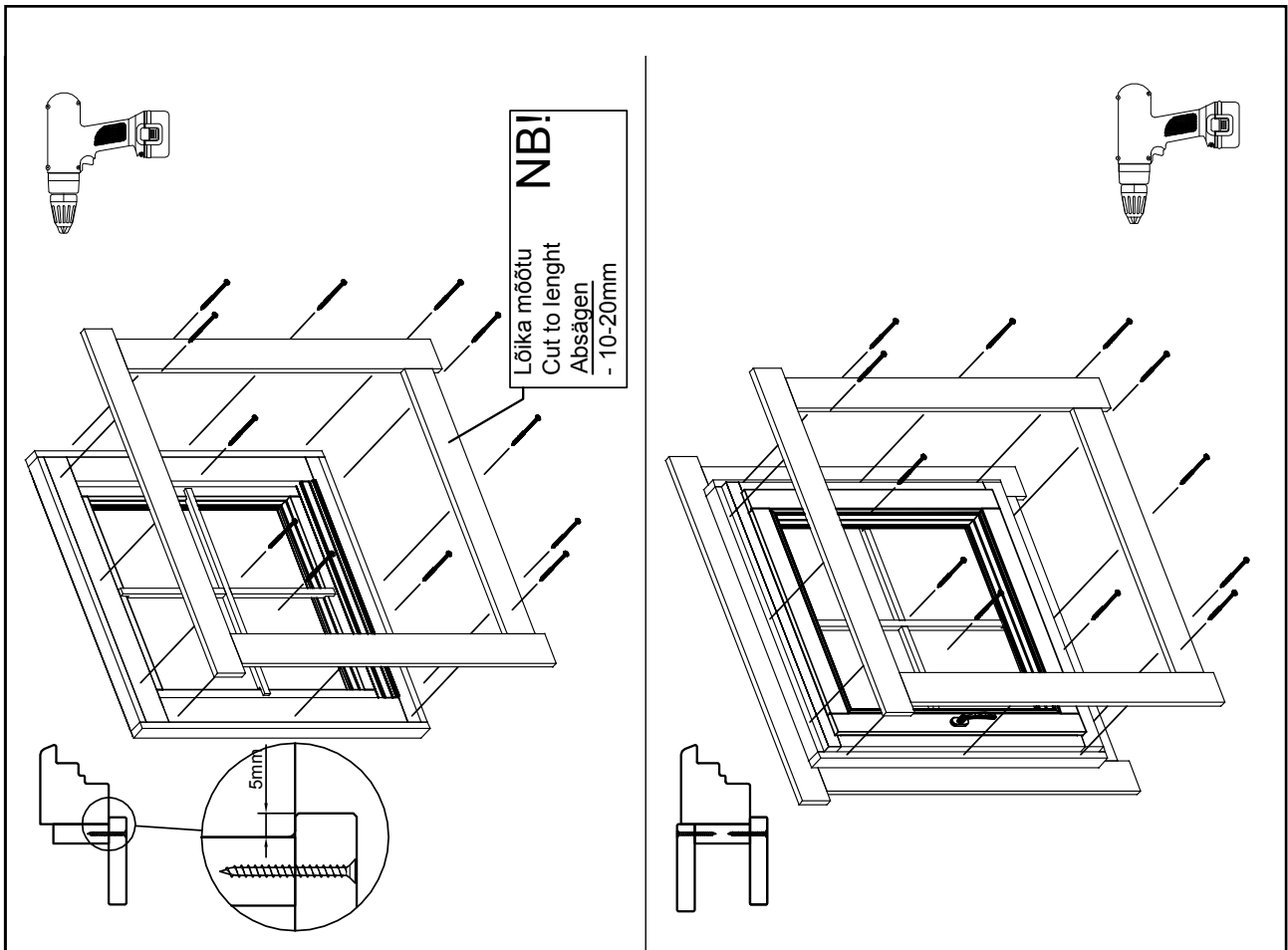

# Detail / optional

## Saunahaus Ella 70 de luxe

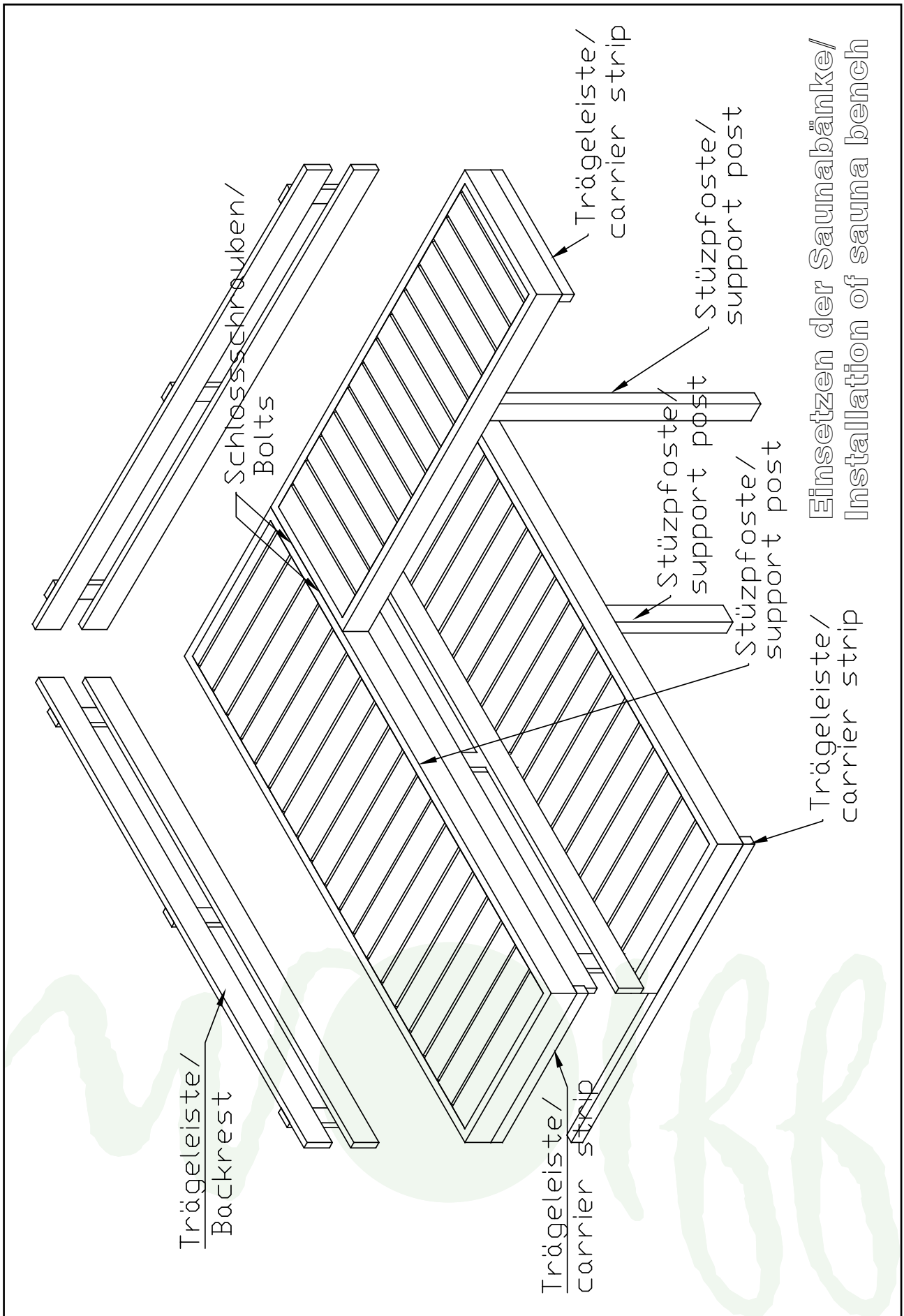

# Detail / optional

## Saunahaus Ella 70 de luxe

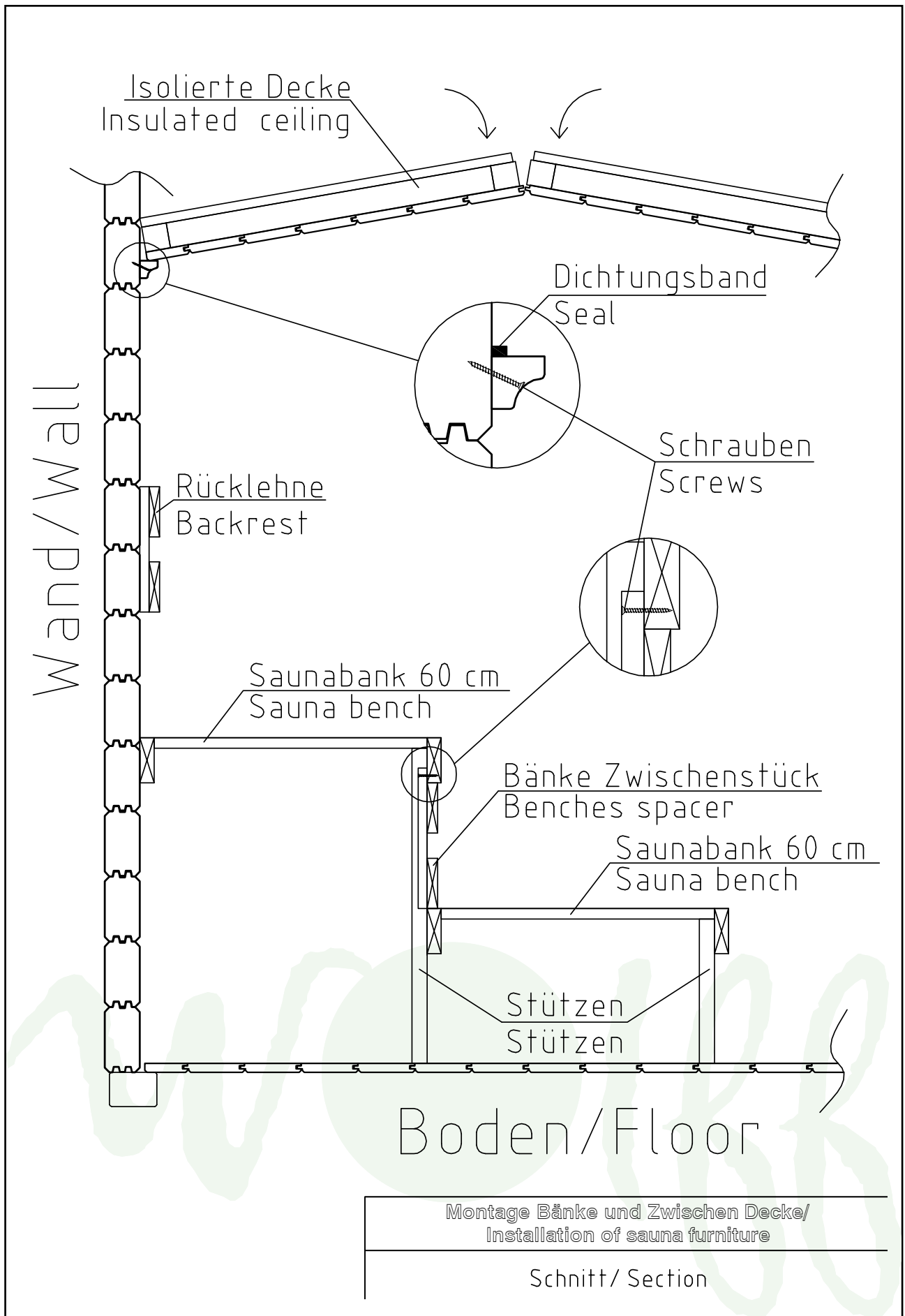



# Detail / optional

## Saunahaus Ella 70 de luxe

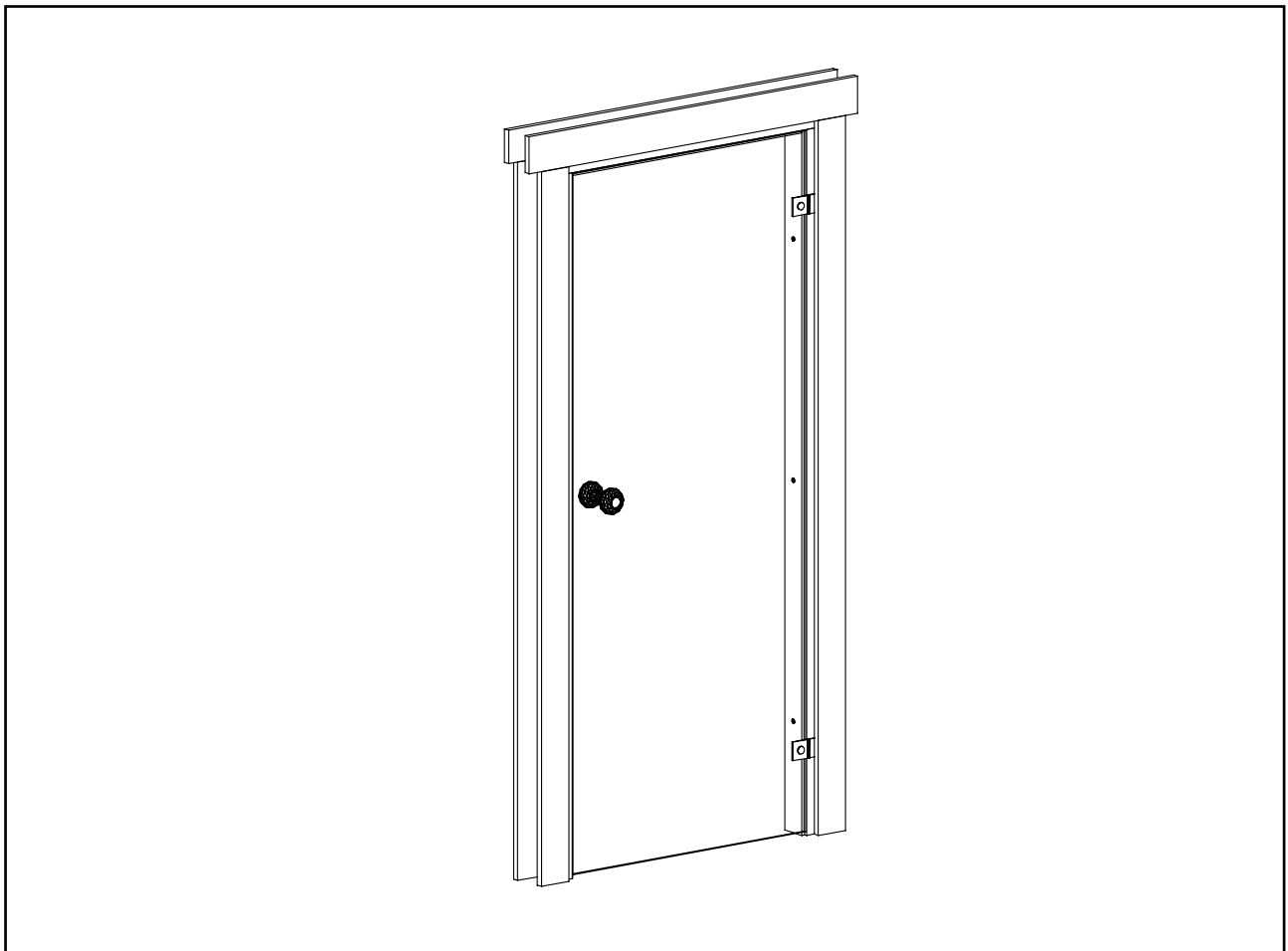

18x90 Blendleisten/  
cover strips/piirdeliistud

Rahmenleisten  
20x Wandstärke/  
frame extensions  
20x wall thickness/  
laiendusliist  
20x seinä paksus

18x90 Blendleisten/  
cover strips/piirdeliistud

# Detail / optional

## Saunahaus Ella 70 de luxe

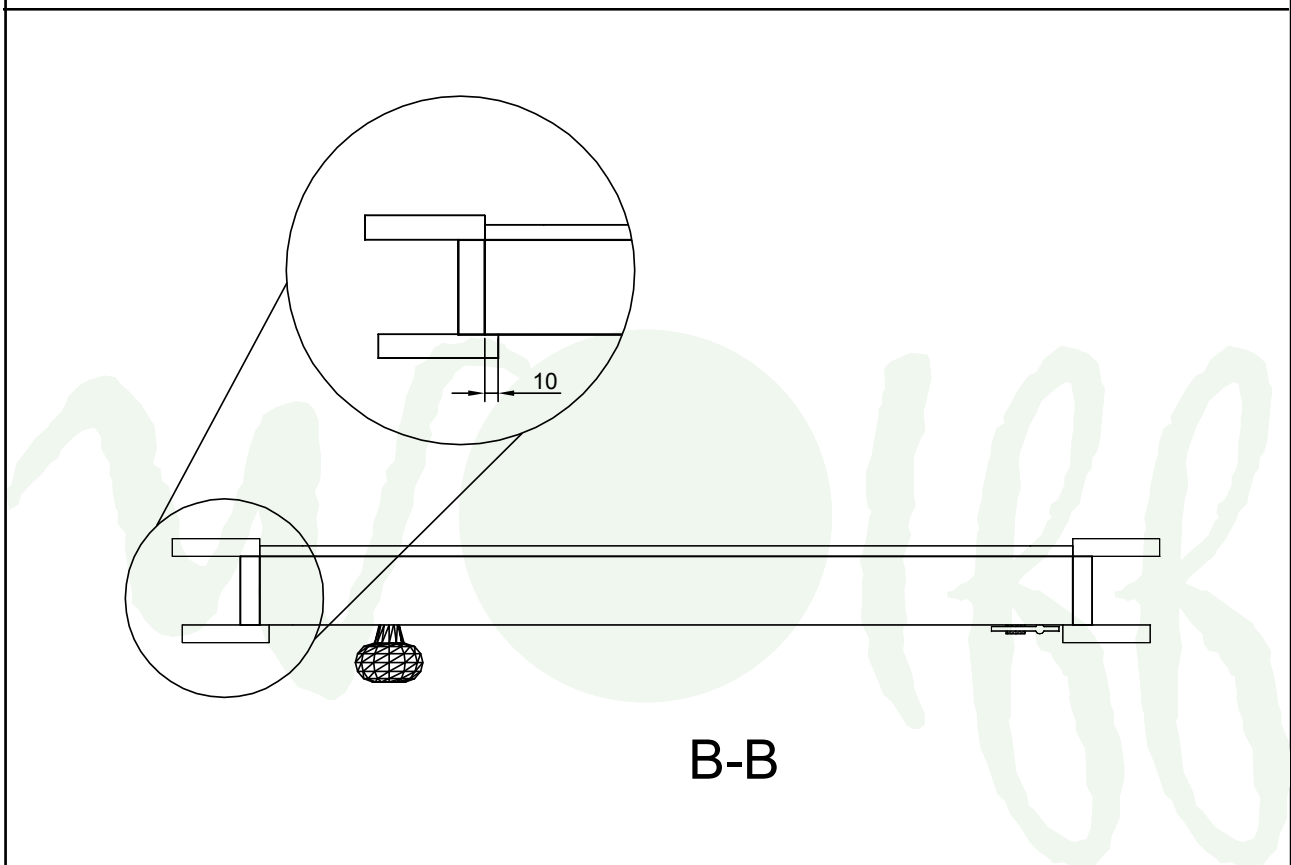
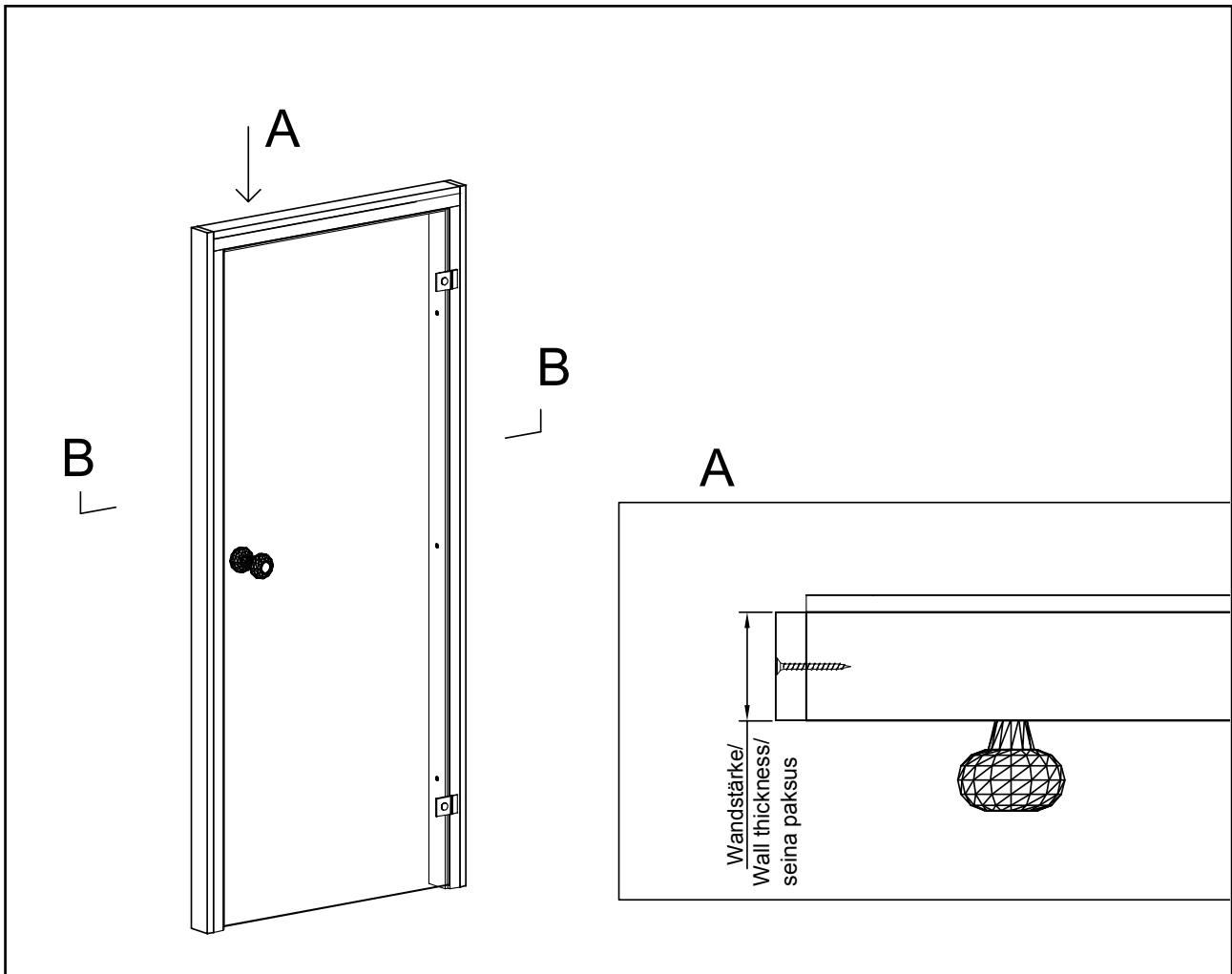

# Detail / optional

## Saunahaus Ella 70 de luxe

