

# HANNU 40

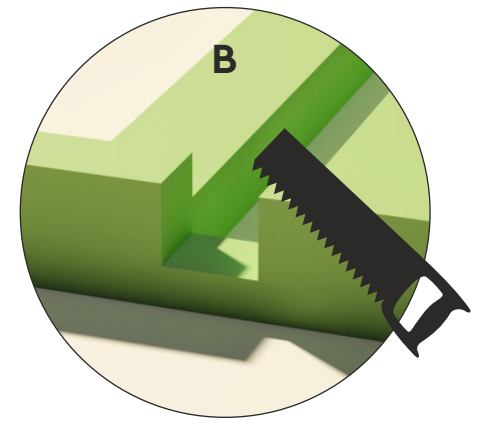

ø 5 mm

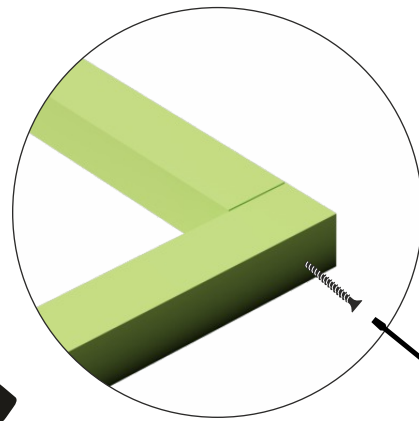
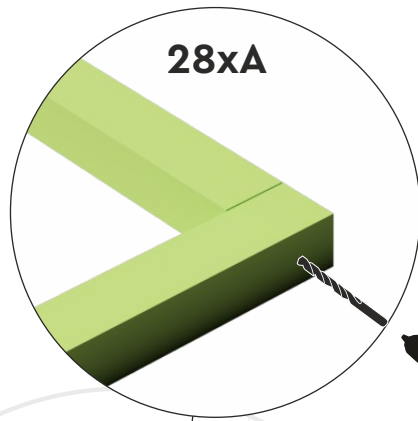

6x140 mm

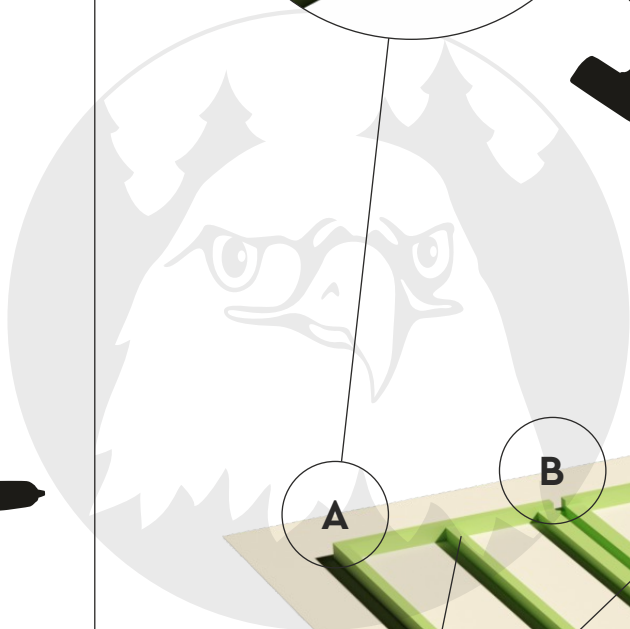

# TEPNE

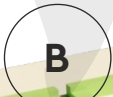

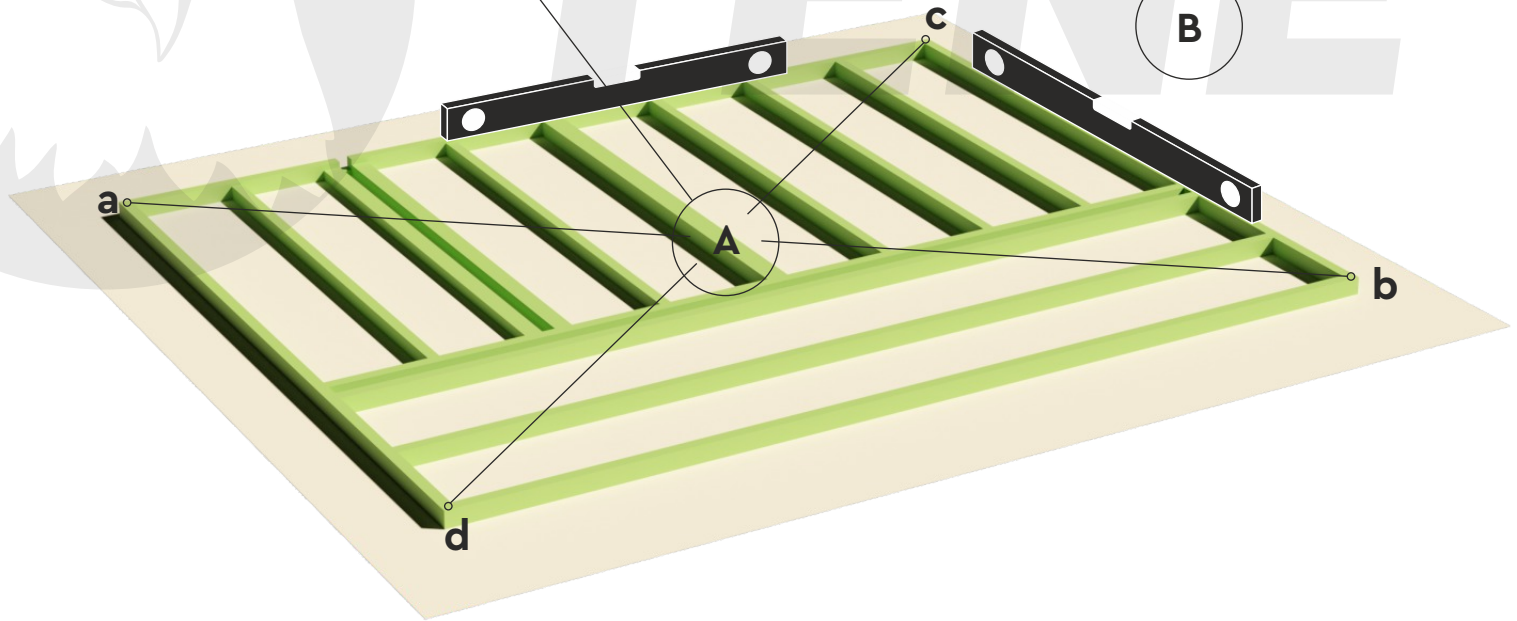
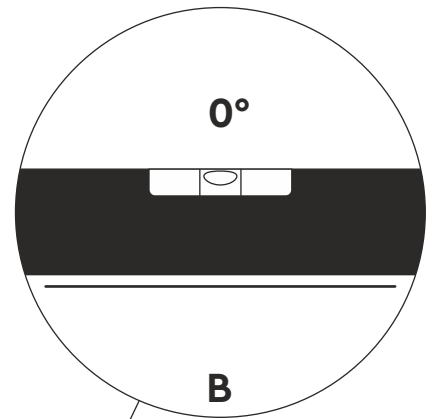
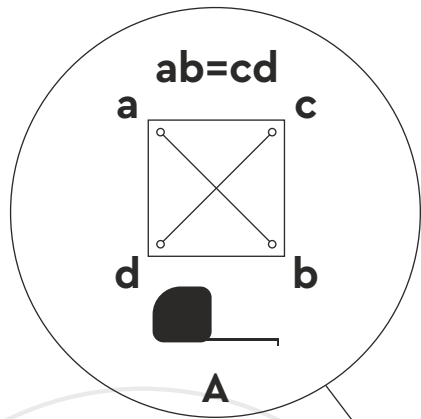

# HANNU 40



Ø 3 mm

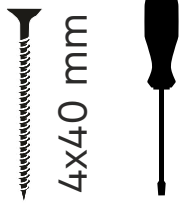

4x40 mm

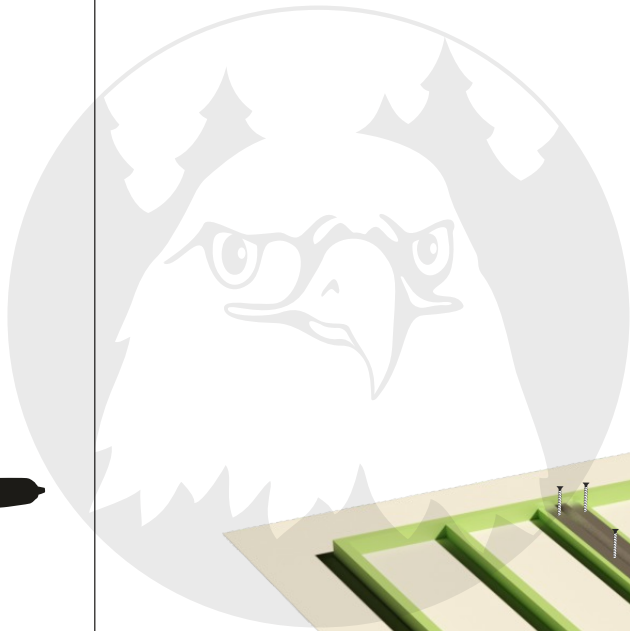

GU

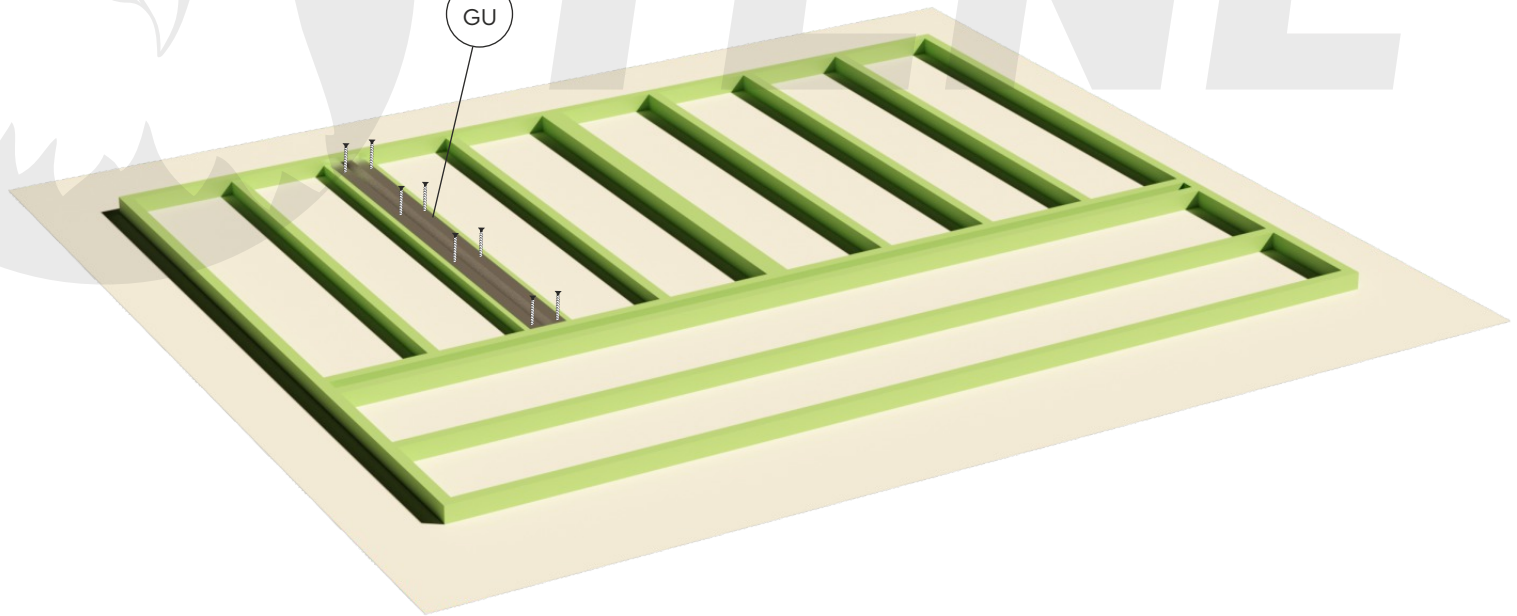



# HANNU 40

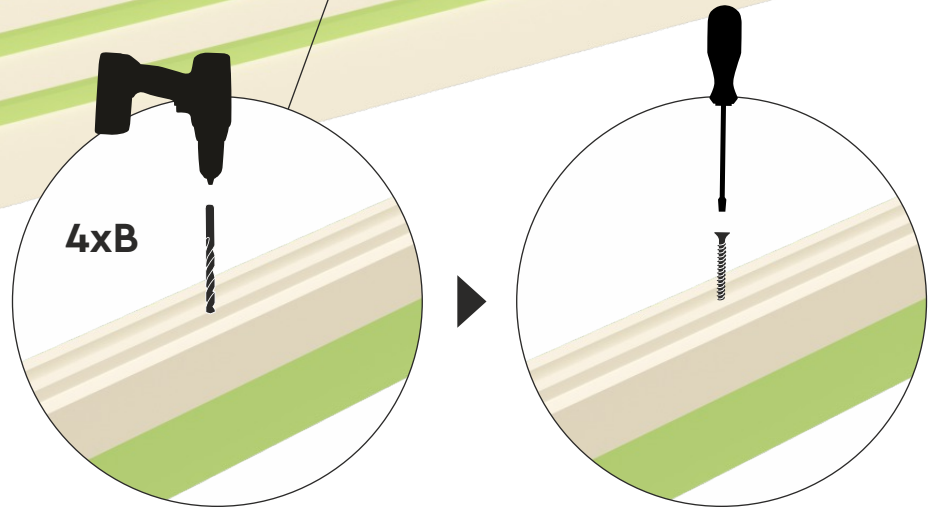
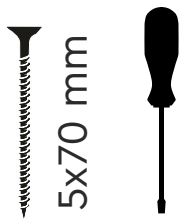
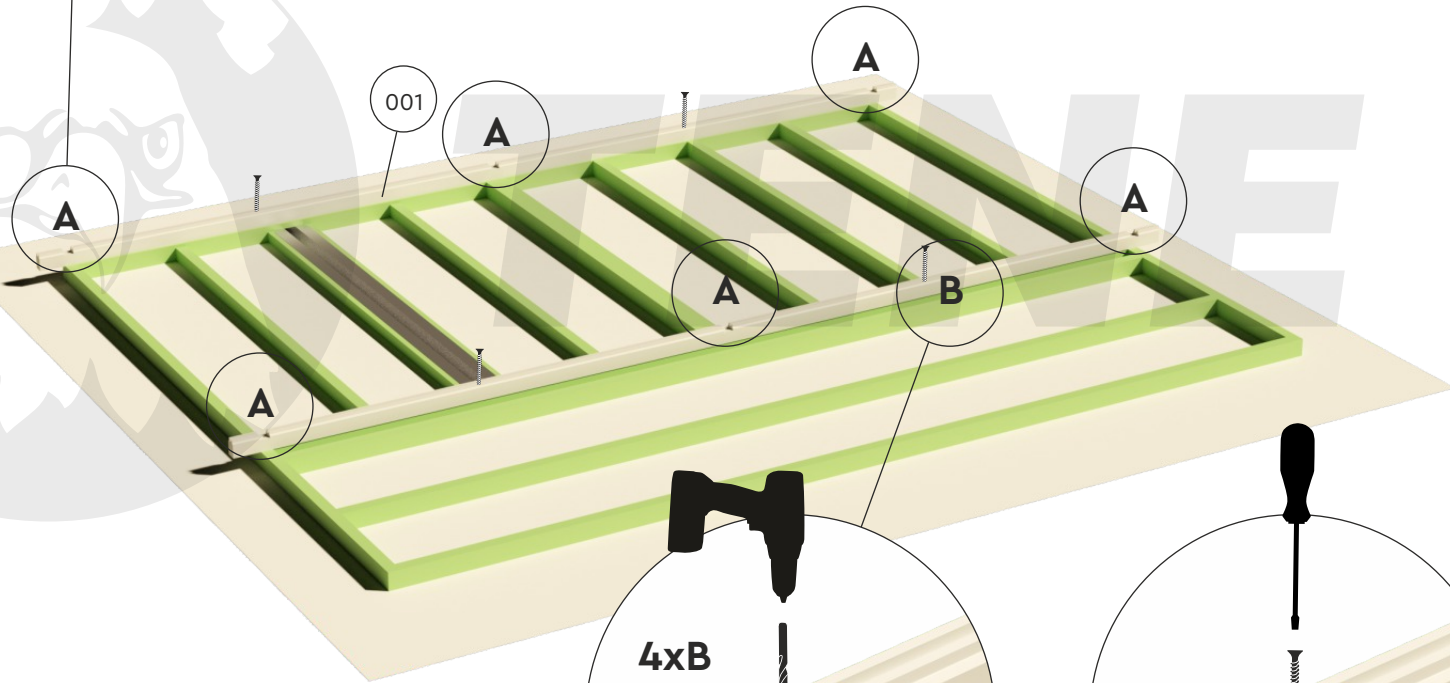
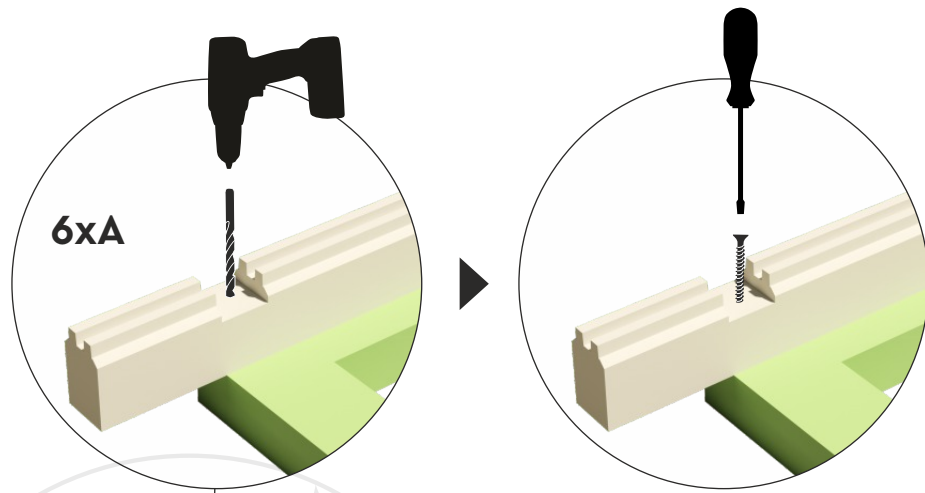

# HANNU 40

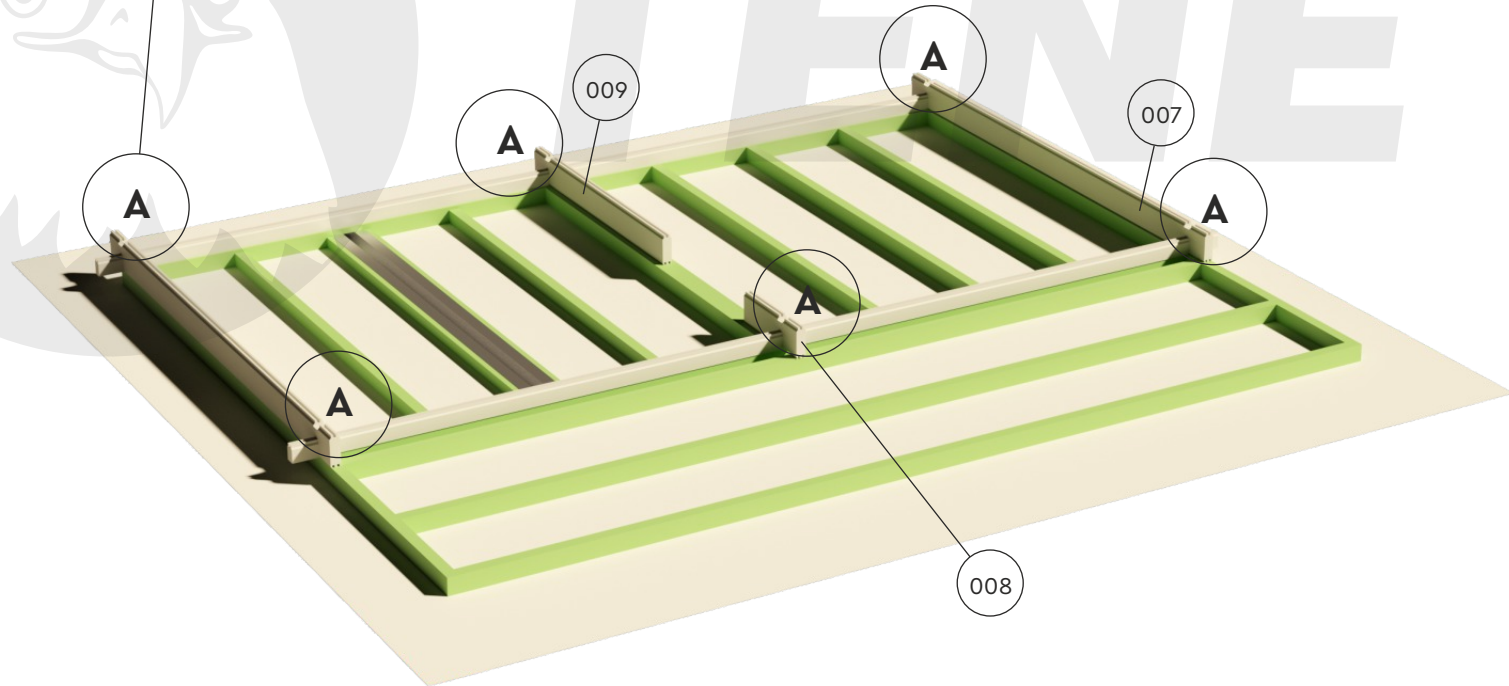
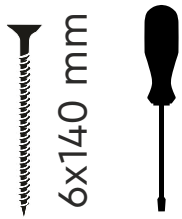
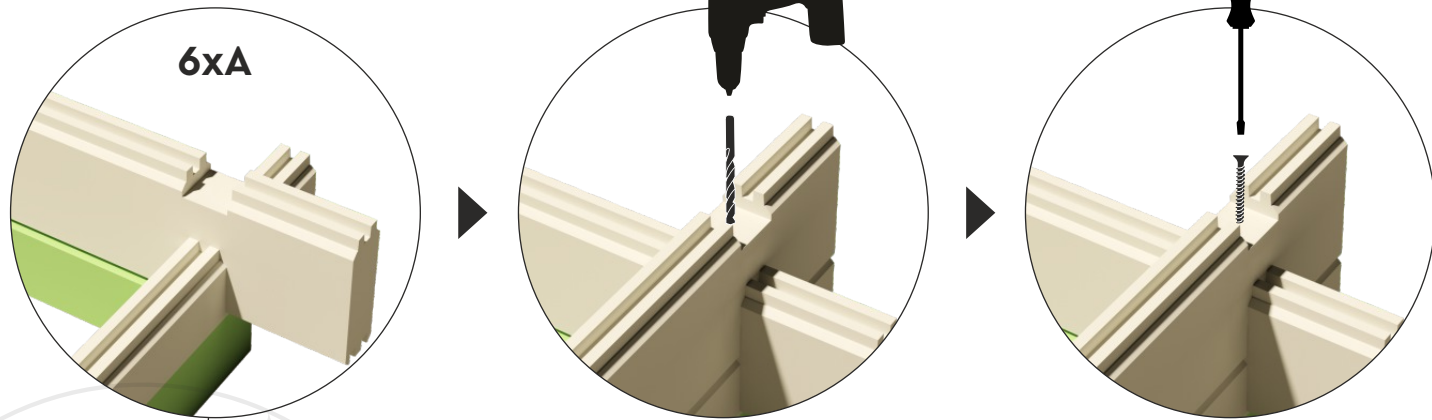

# HANNU 40

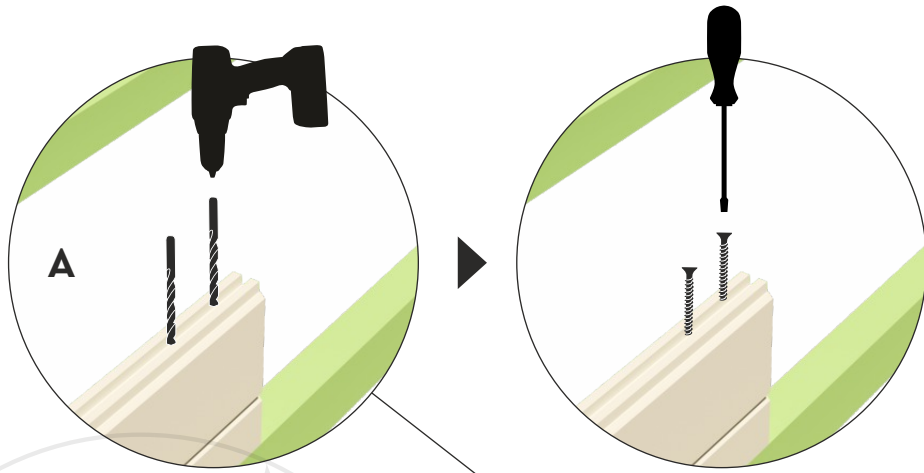

Ø 5 mm

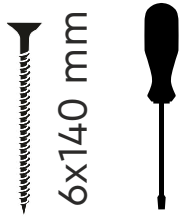

6x140 mm

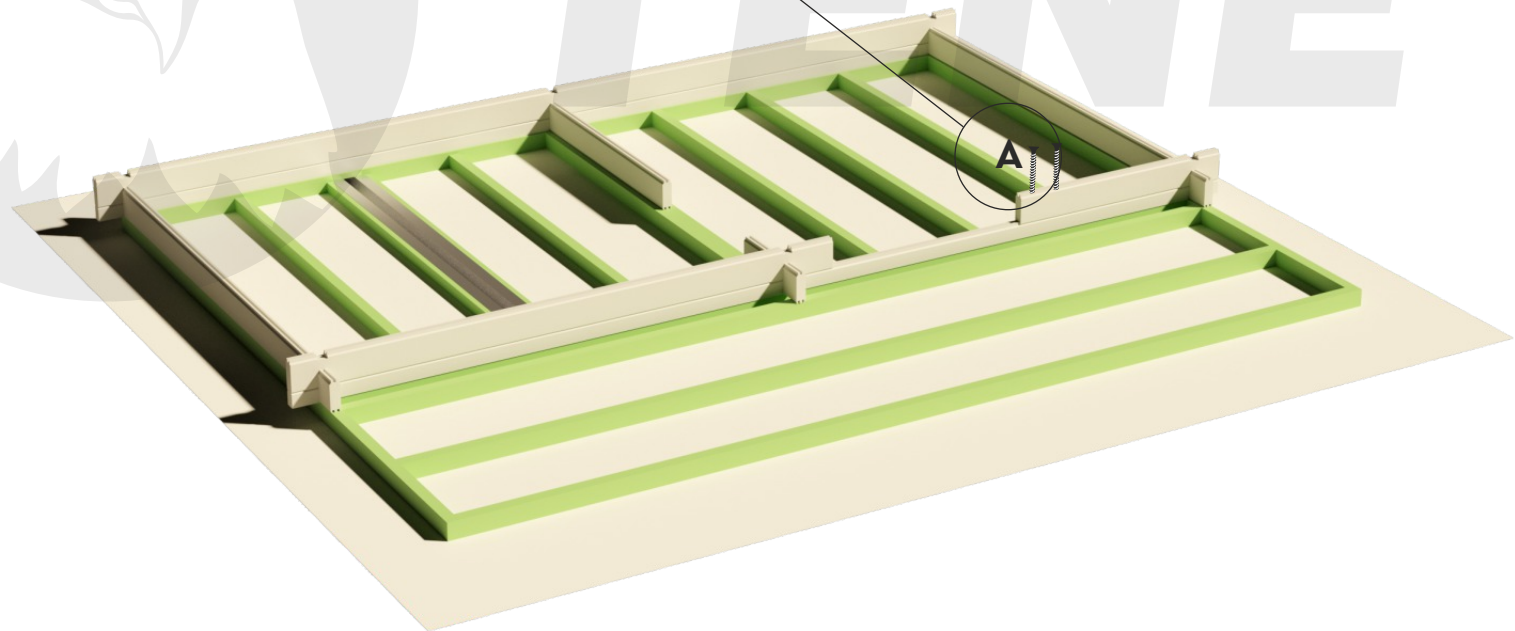

# HANNU 40

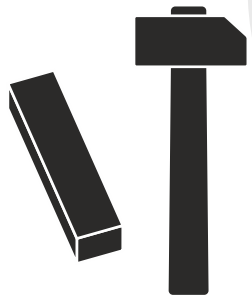
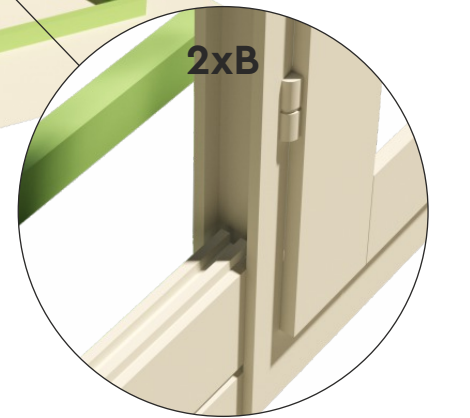
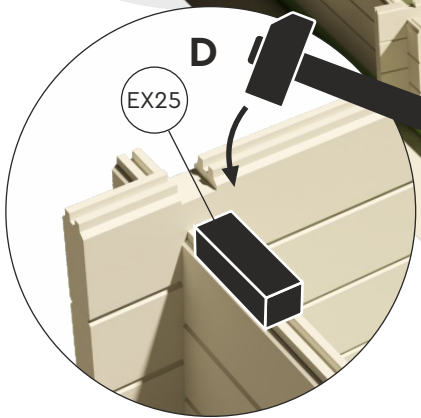
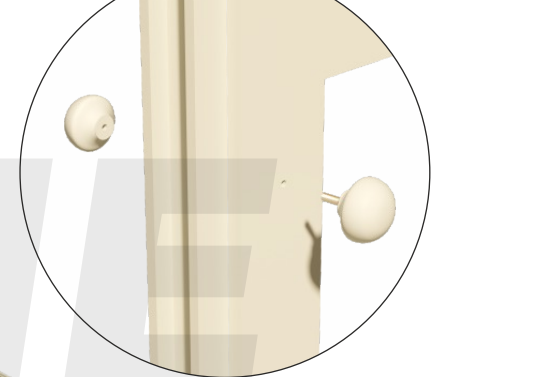
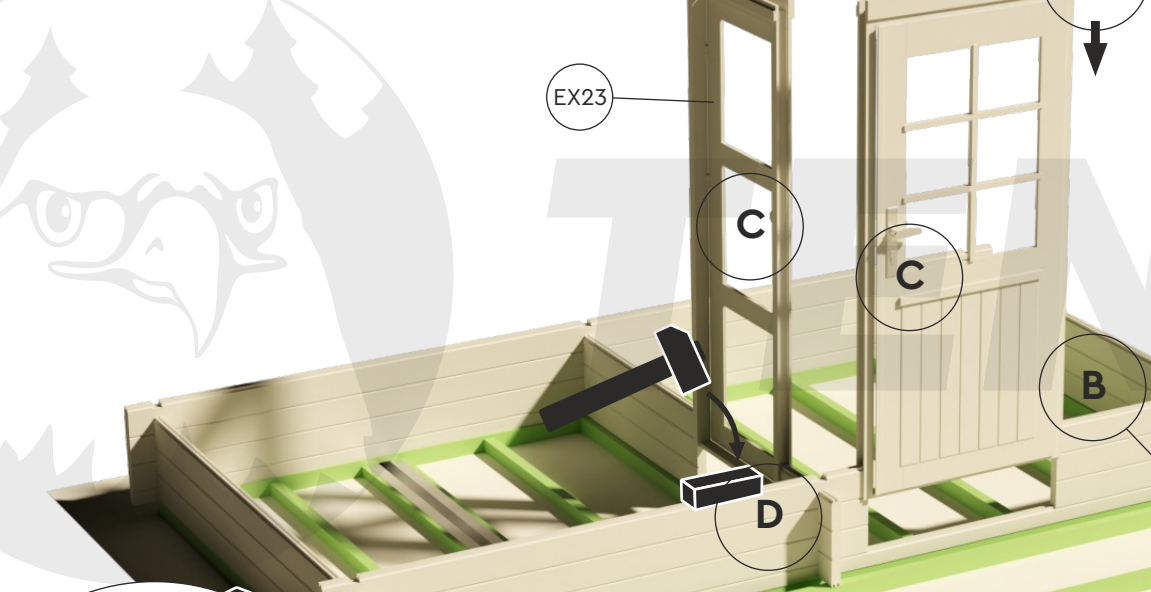
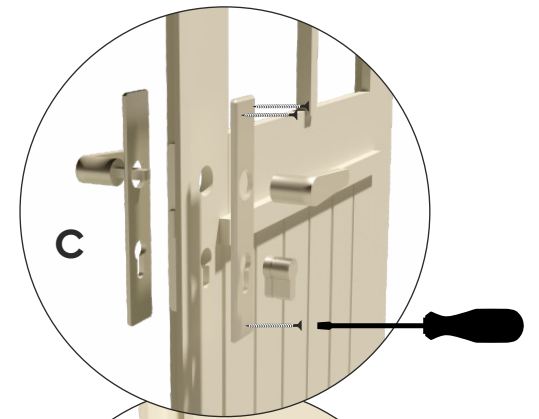
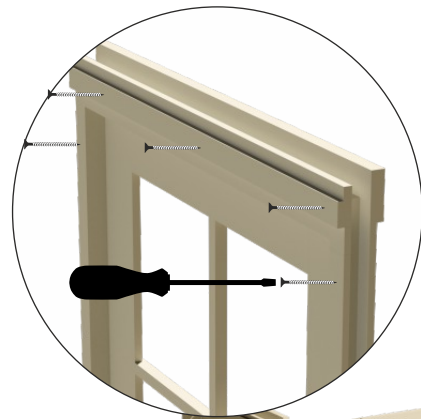
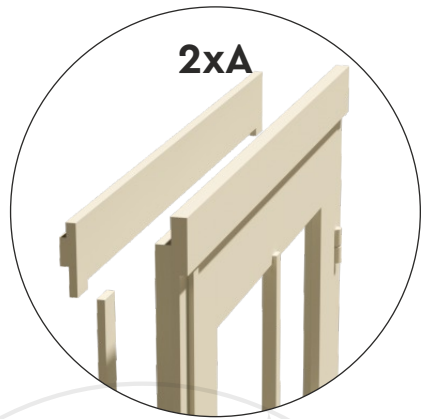



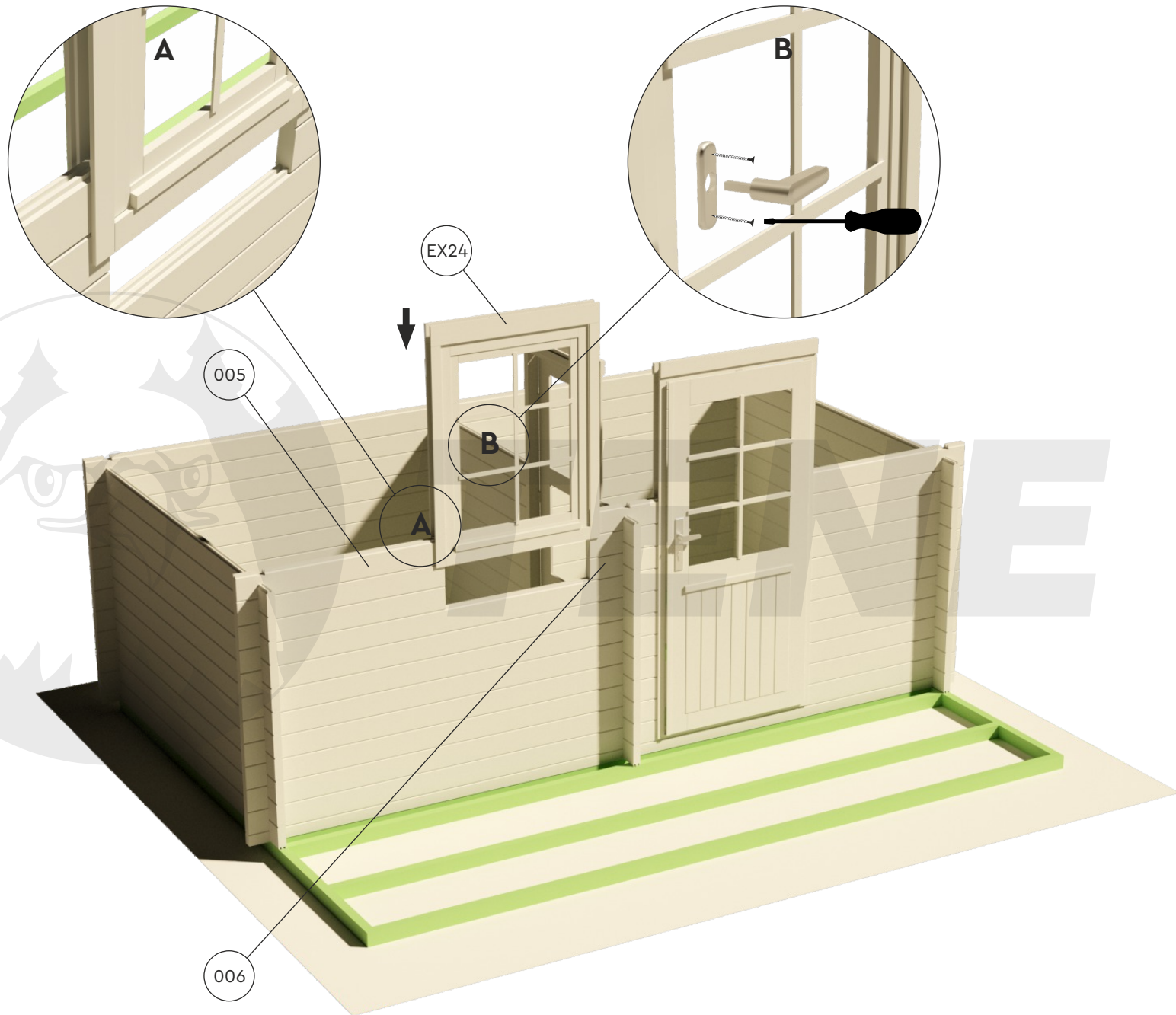



# HANNU 40

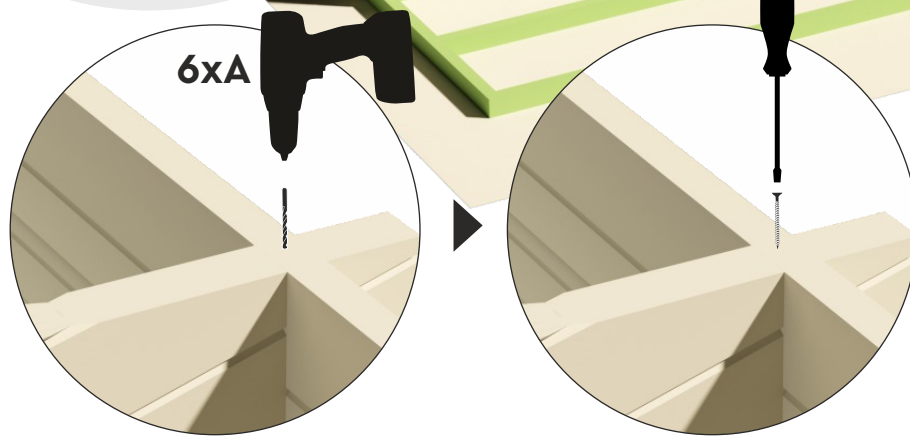
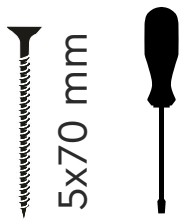
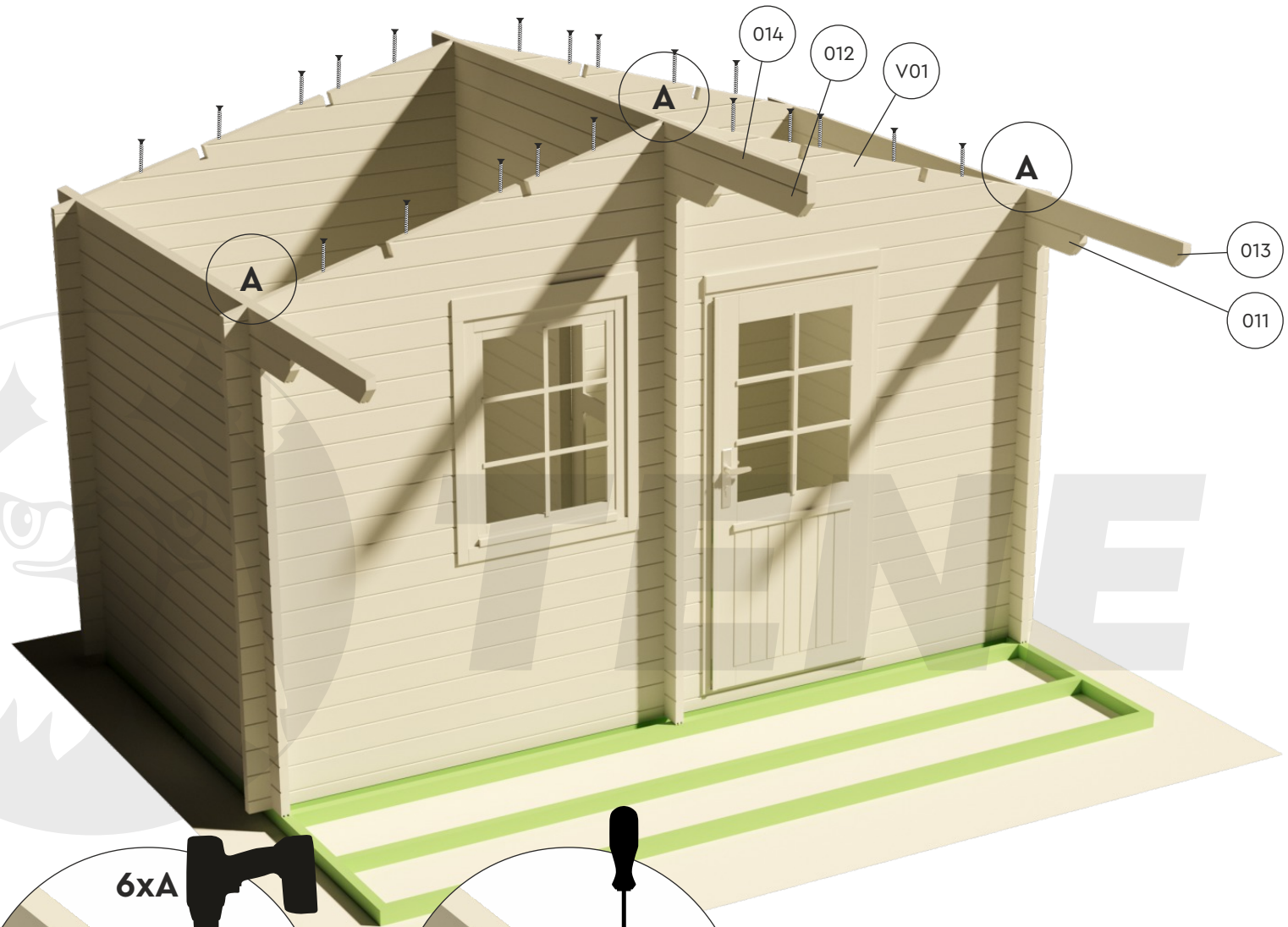

# HANNU 40

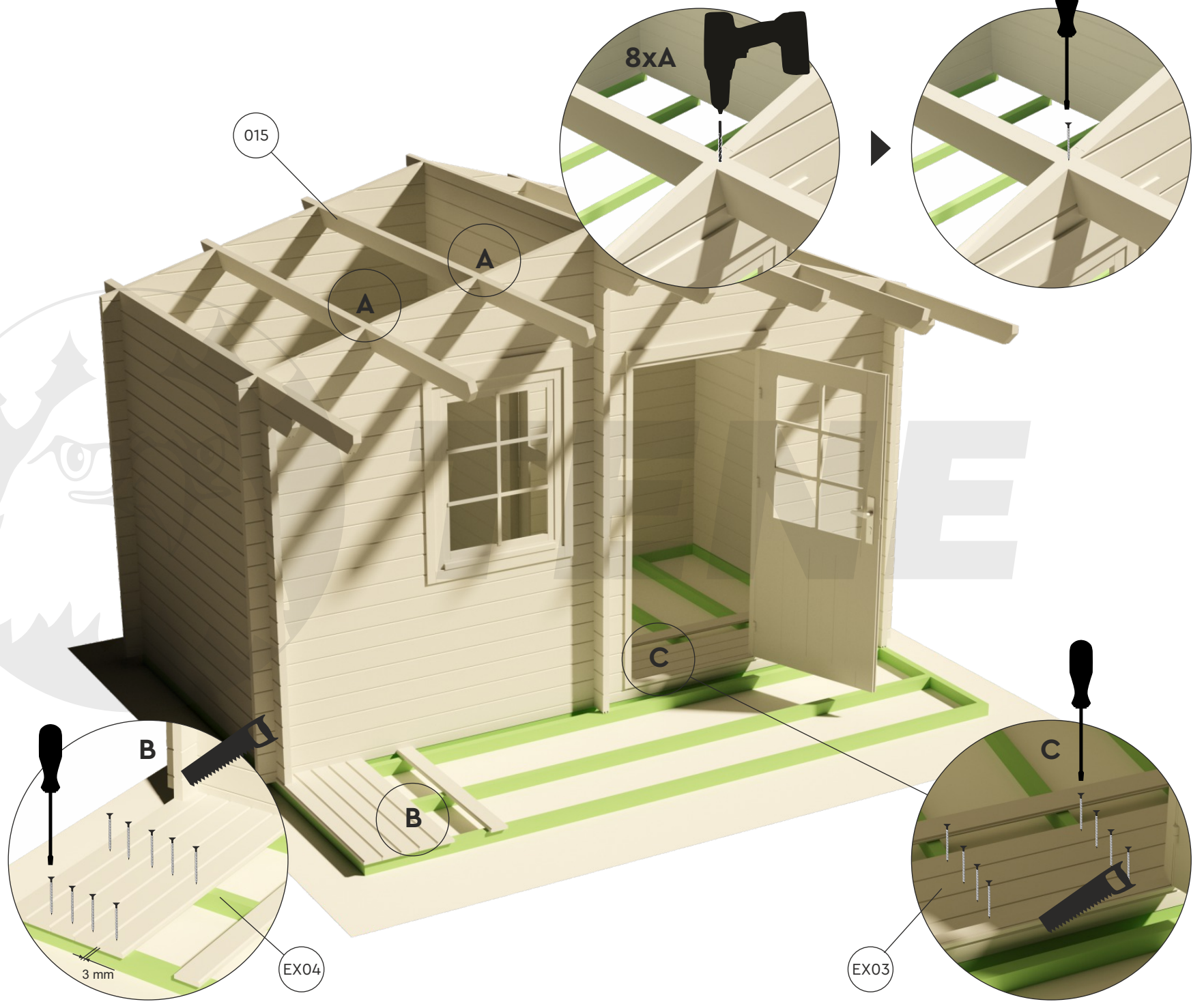
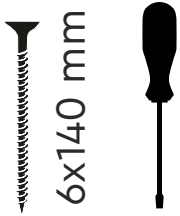

# HANNU 40

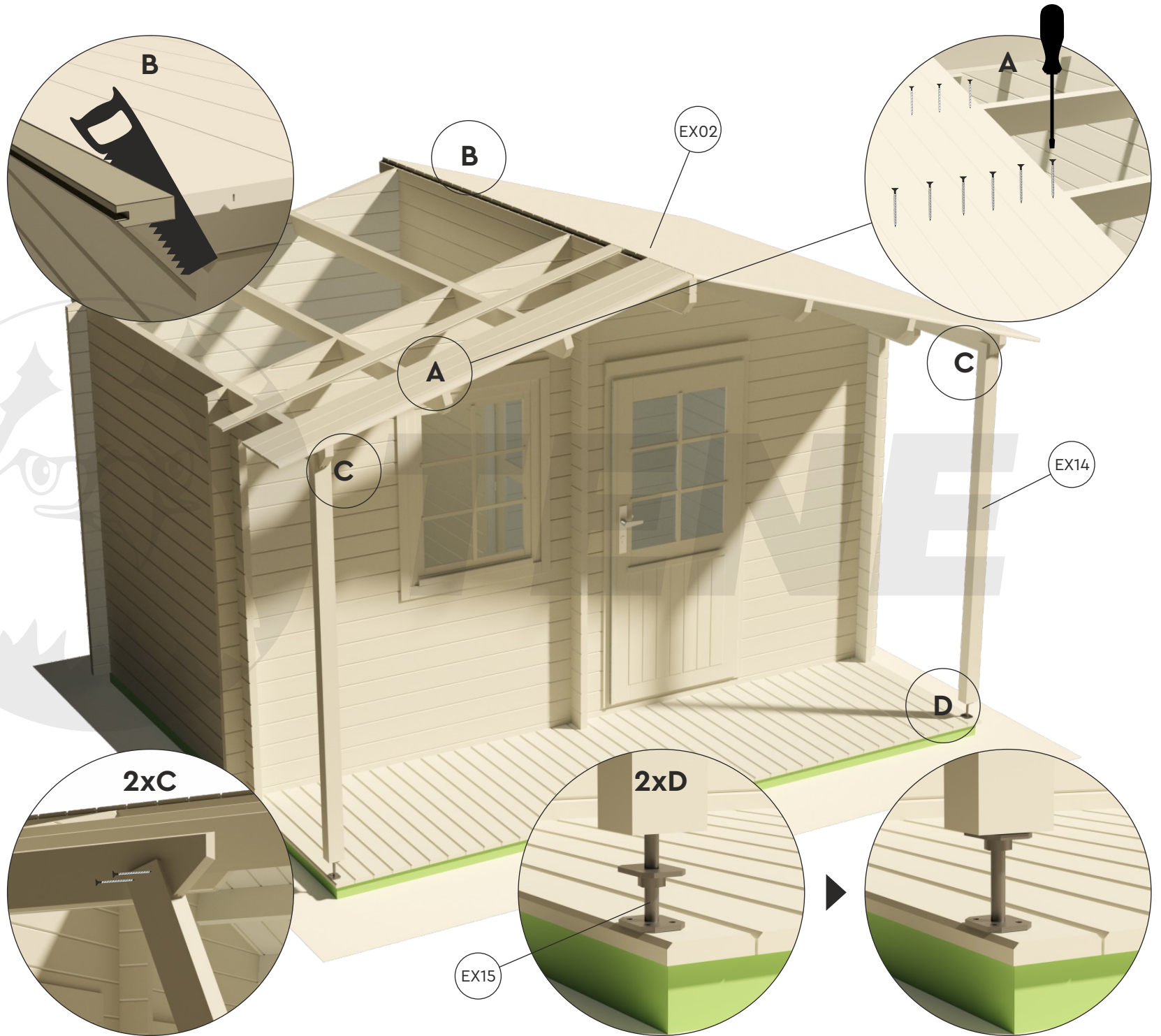

4x50 mm





# HANNU 40

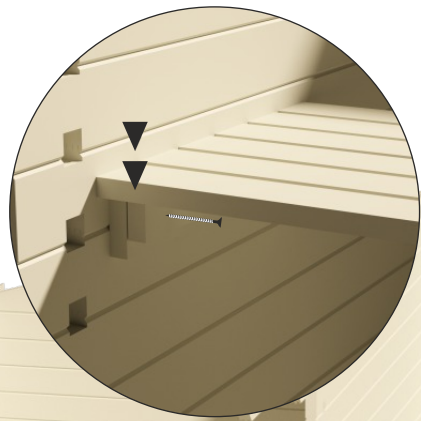
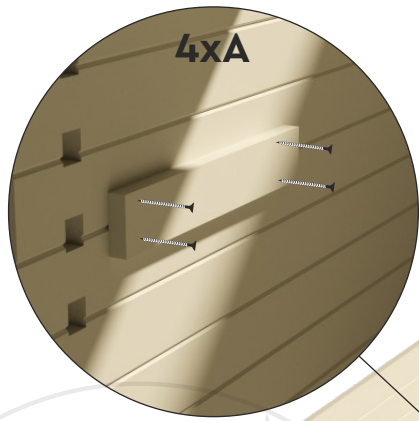

EX17

A

A

# HANNU 40

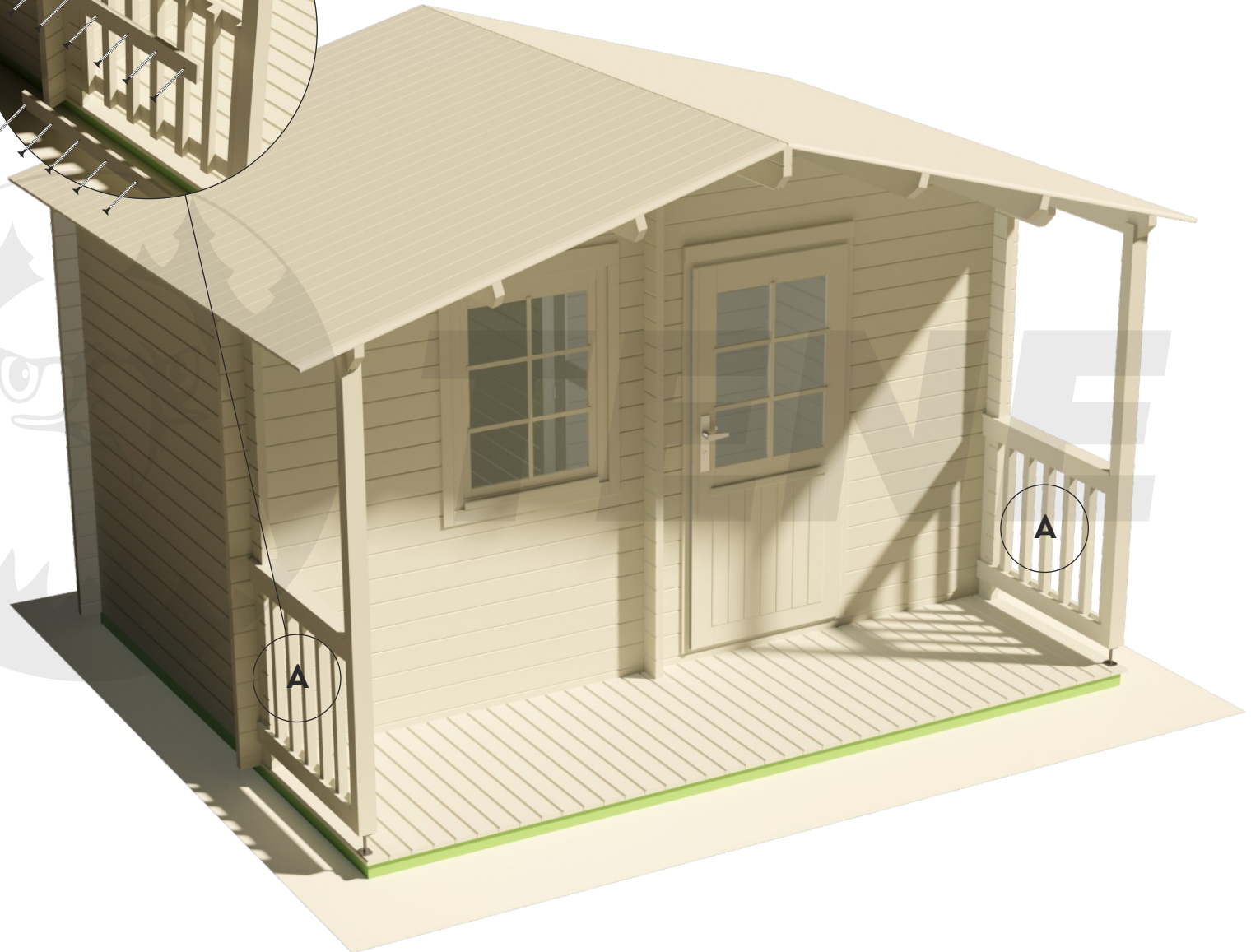
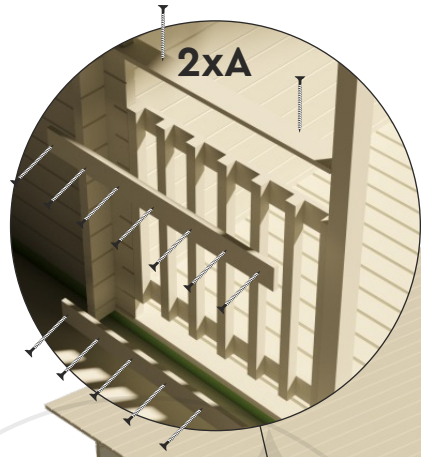

4x50 mm





# HANNU 40

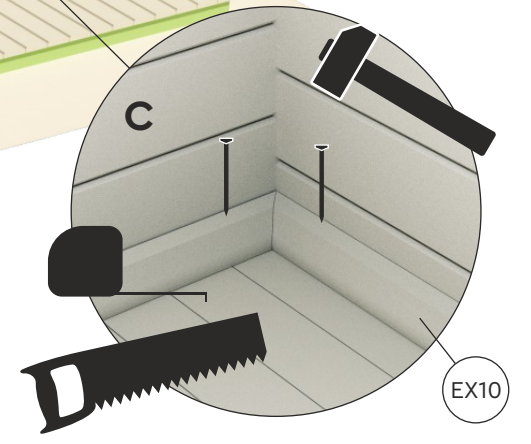
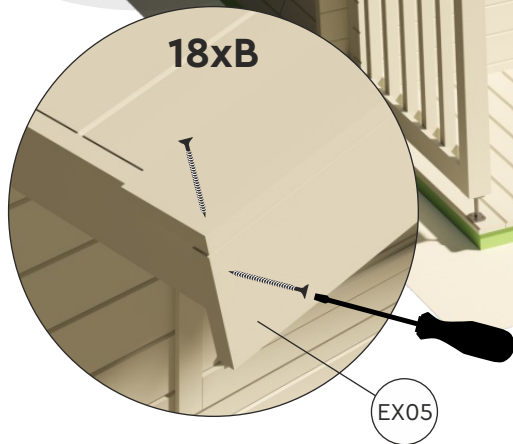
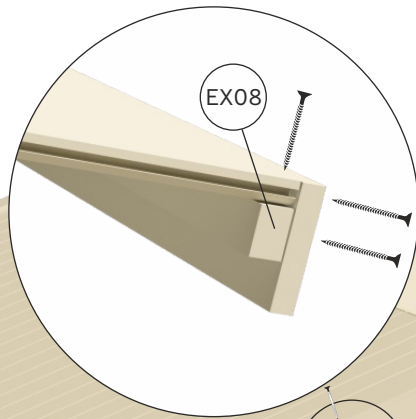
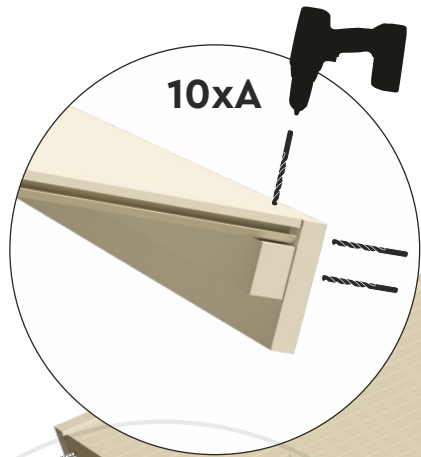
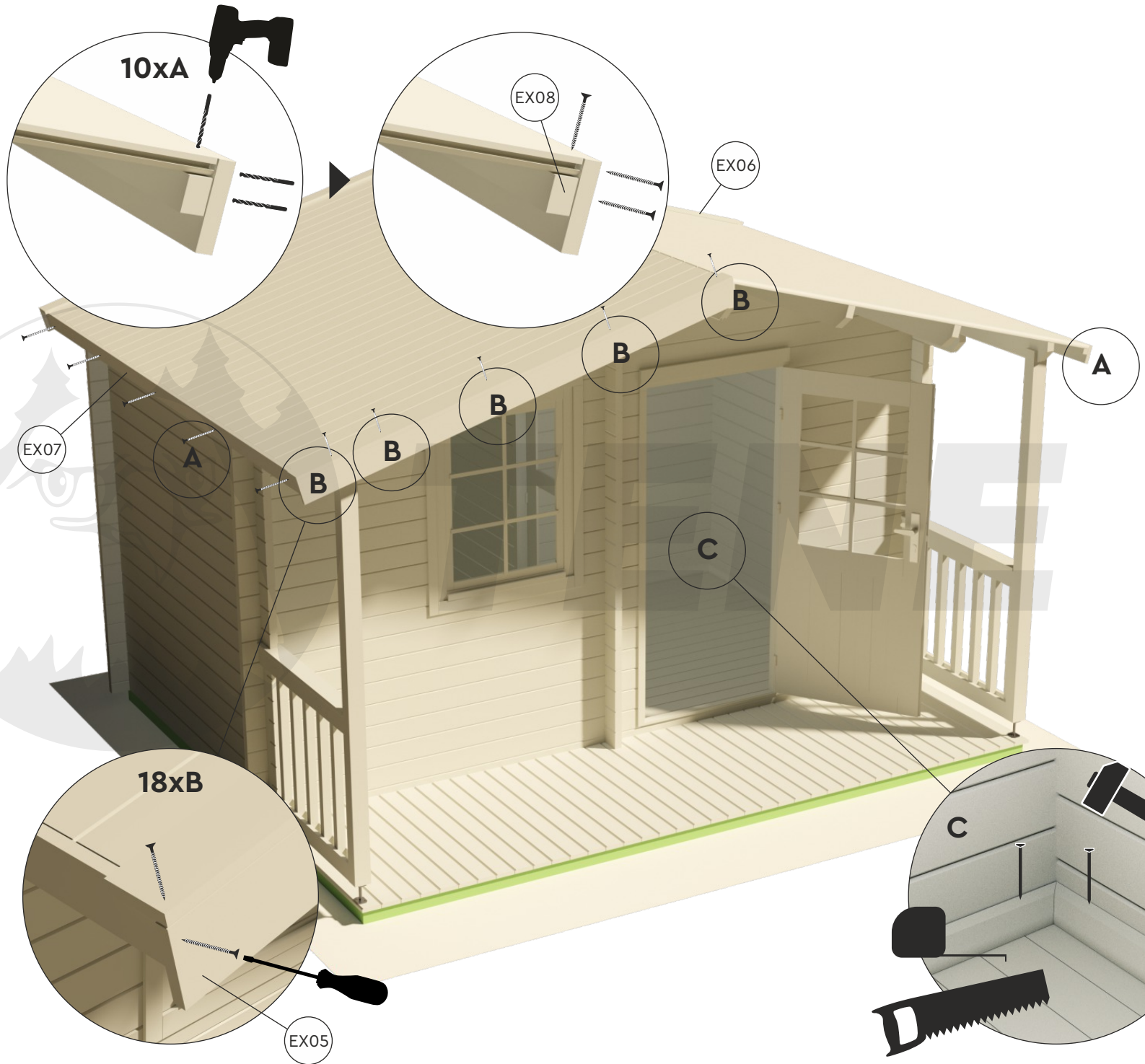
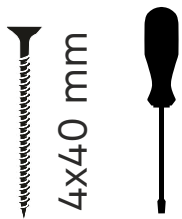
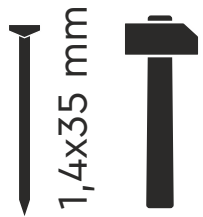
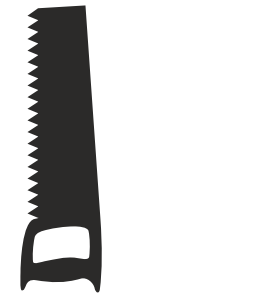

# HANNU 40

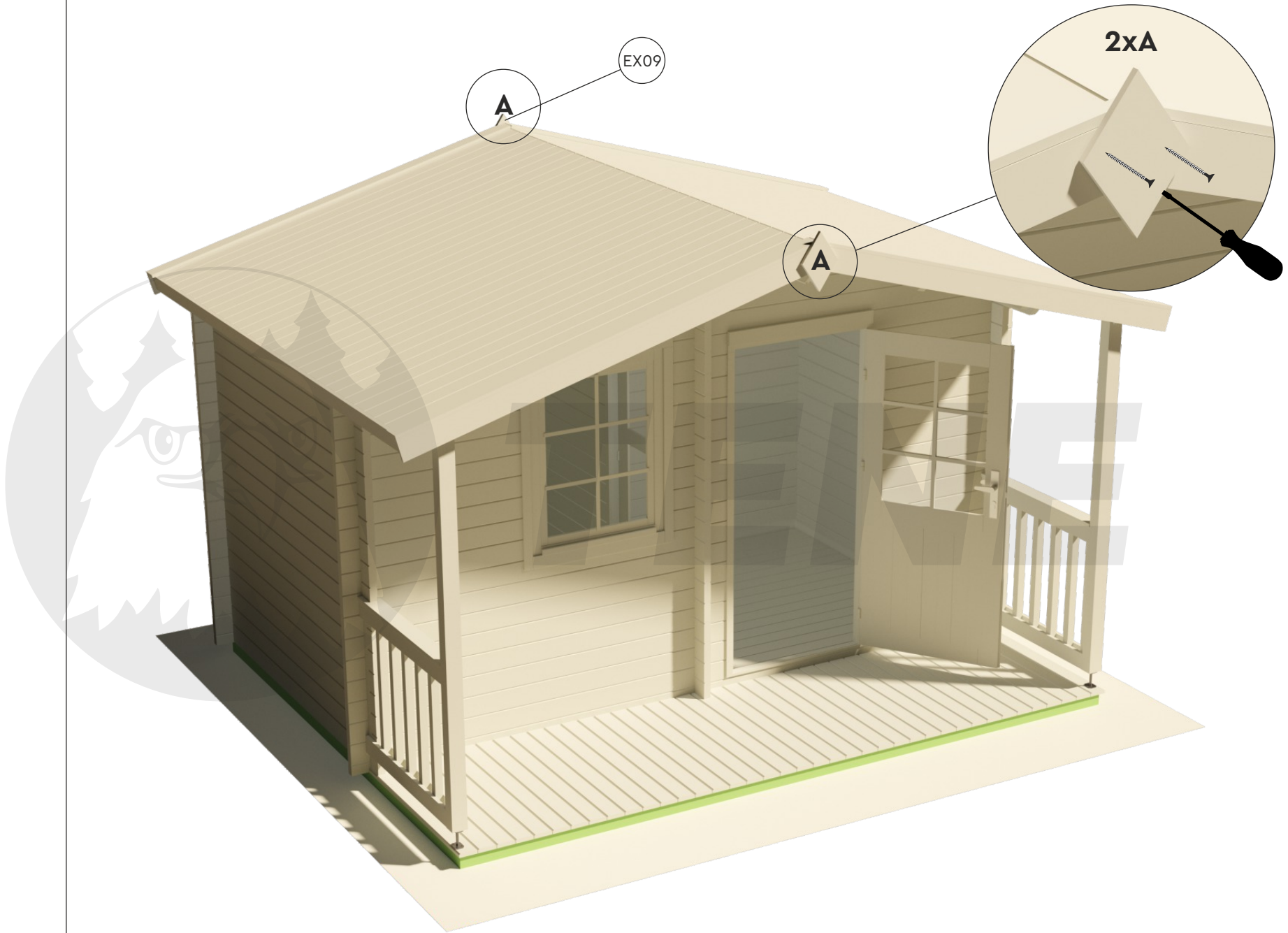

4x40 mm



# HANNU 40

