

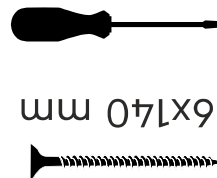

∅ 4 mm

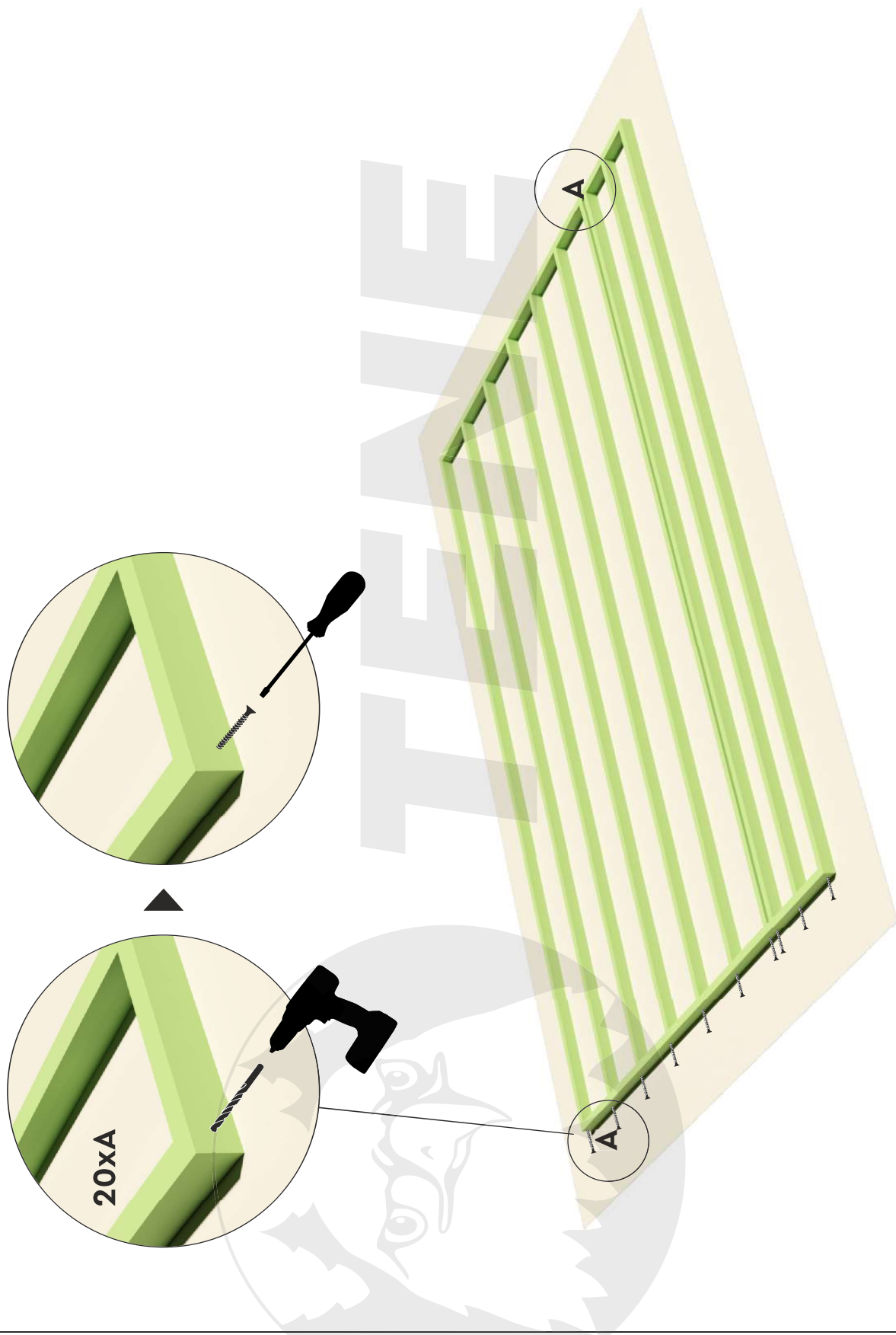

6x140 mm

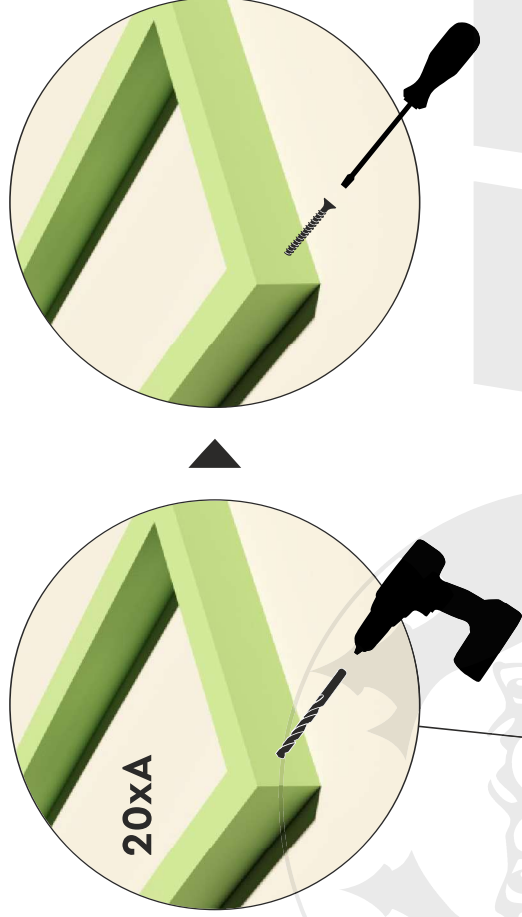

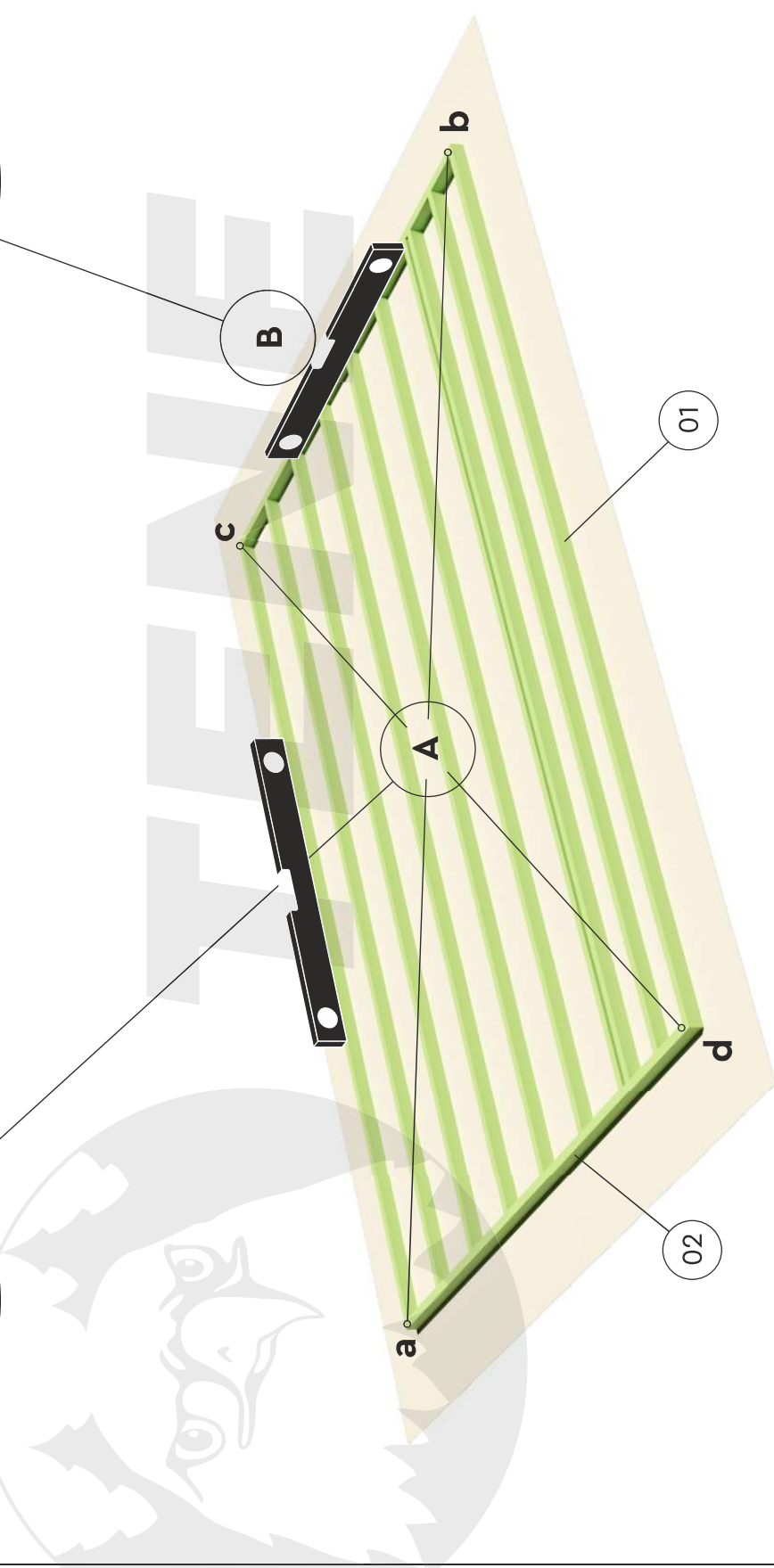
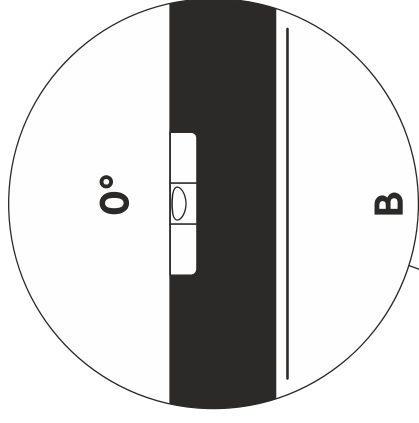
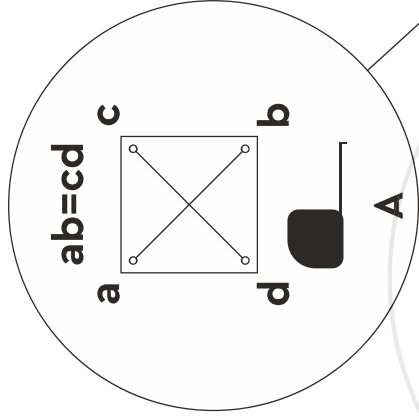



∅ 4 mm

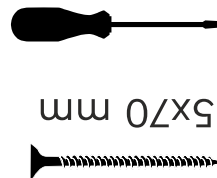

5x70 mm

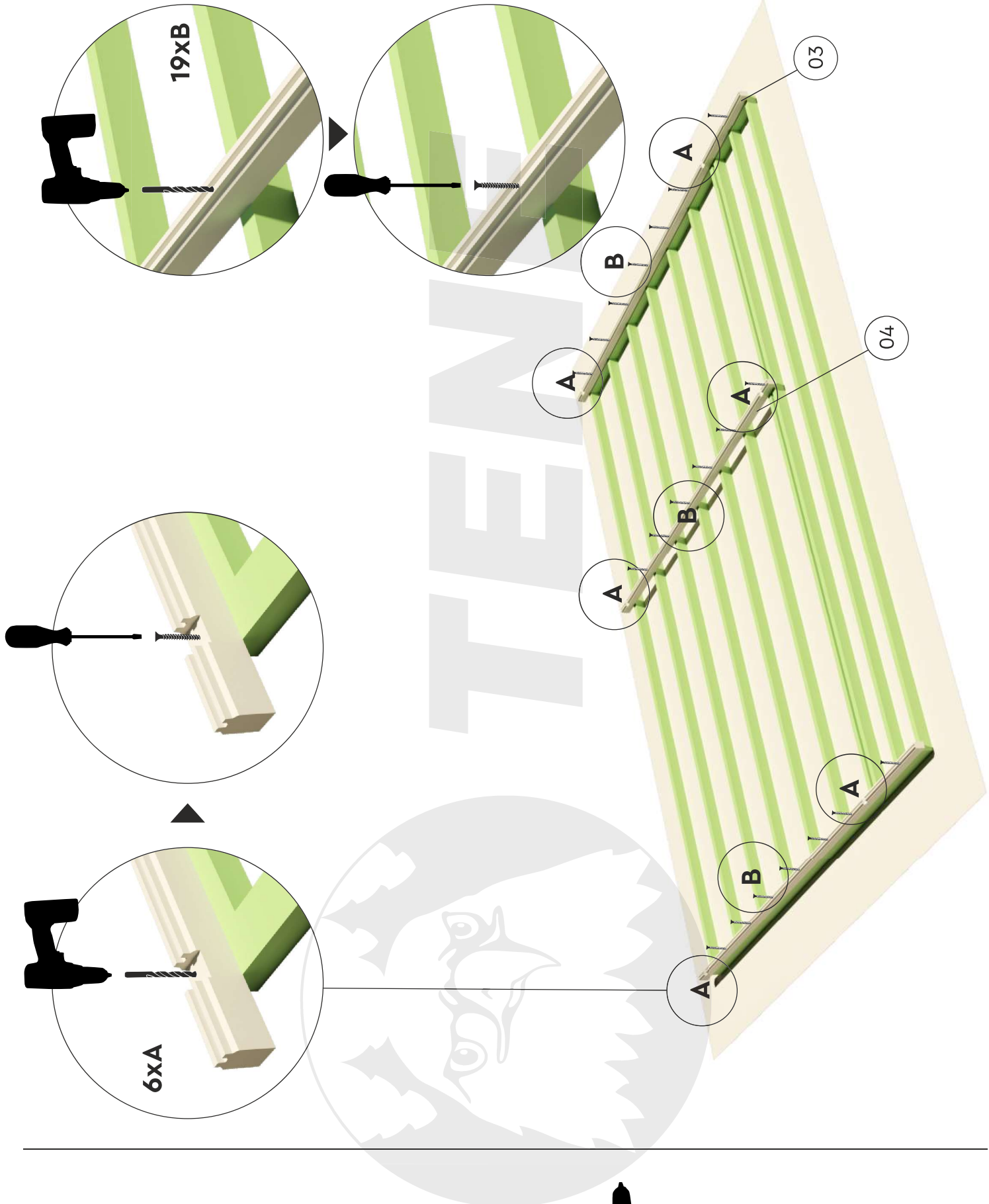



∅ 5 mm

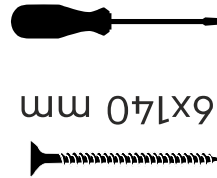

6x140 mm

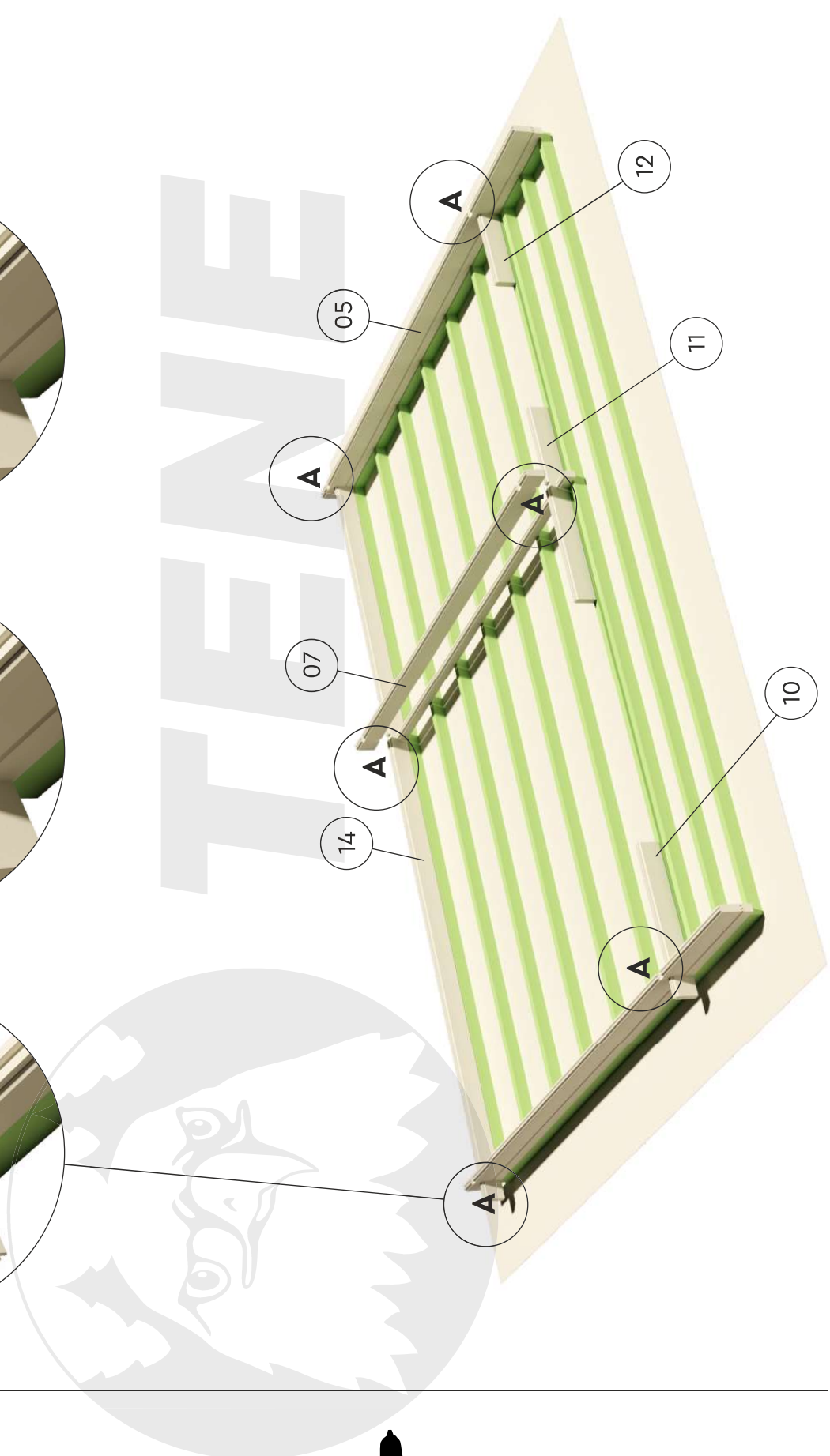
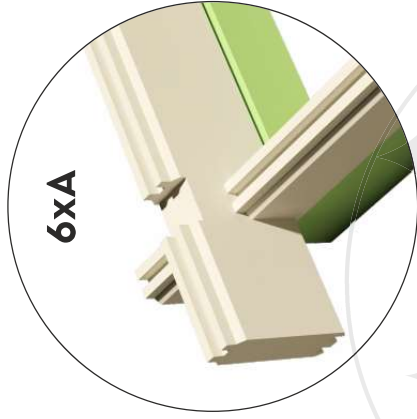
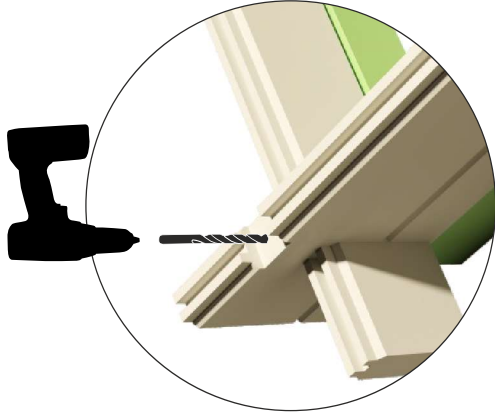
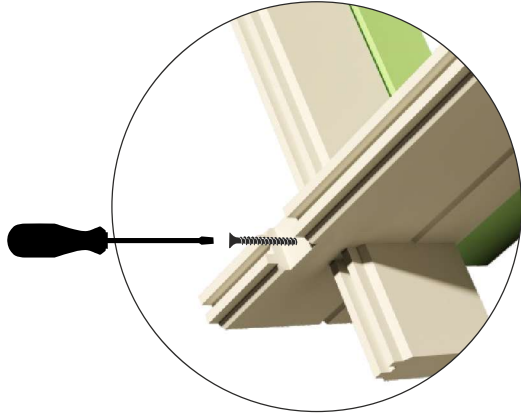



∅ 5 mm

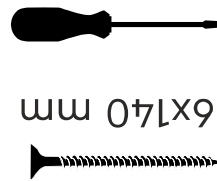

6x140 mm

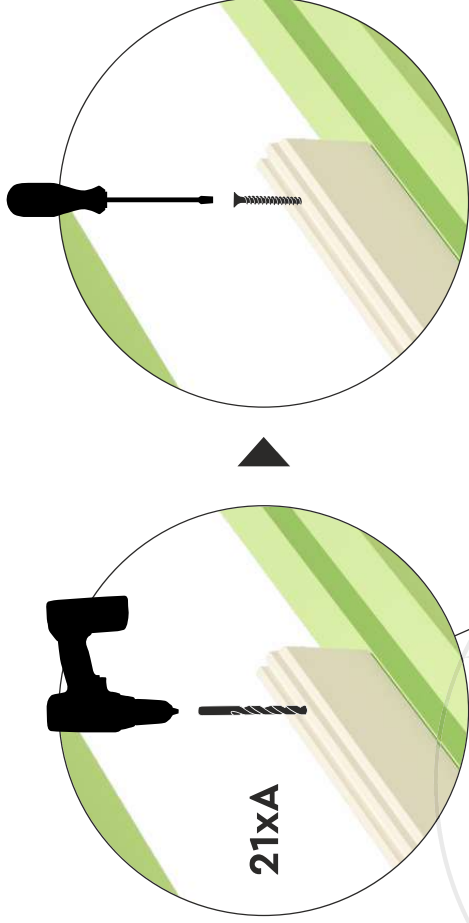

21xA

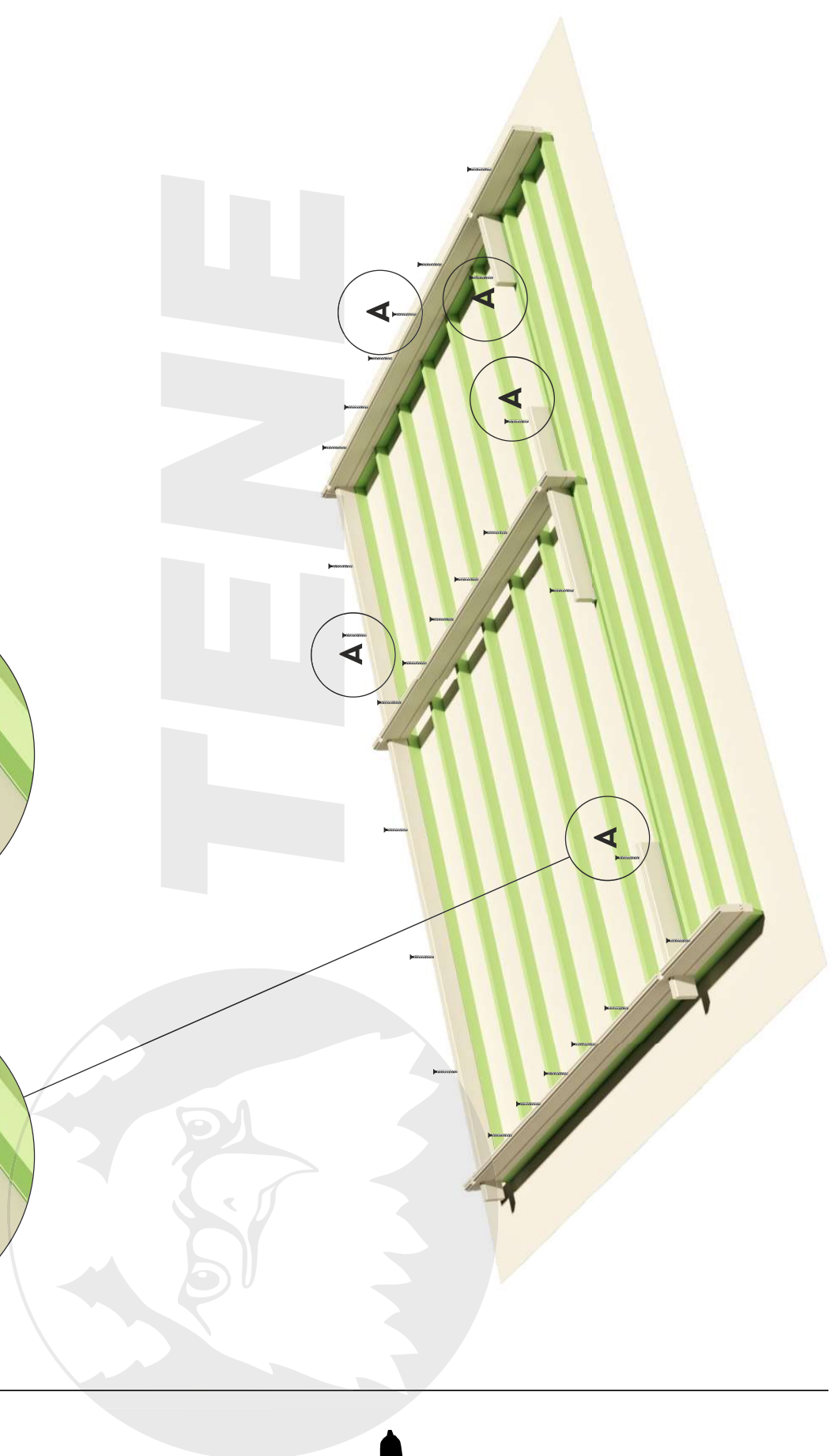

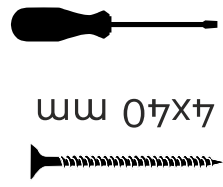
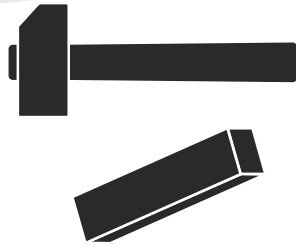

4x40 mm

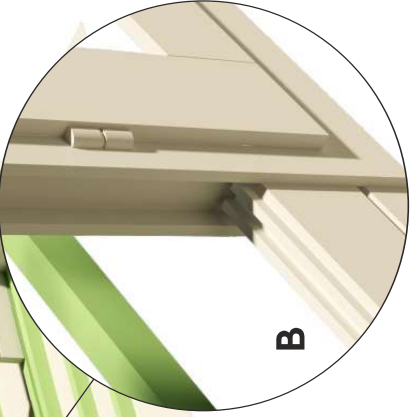
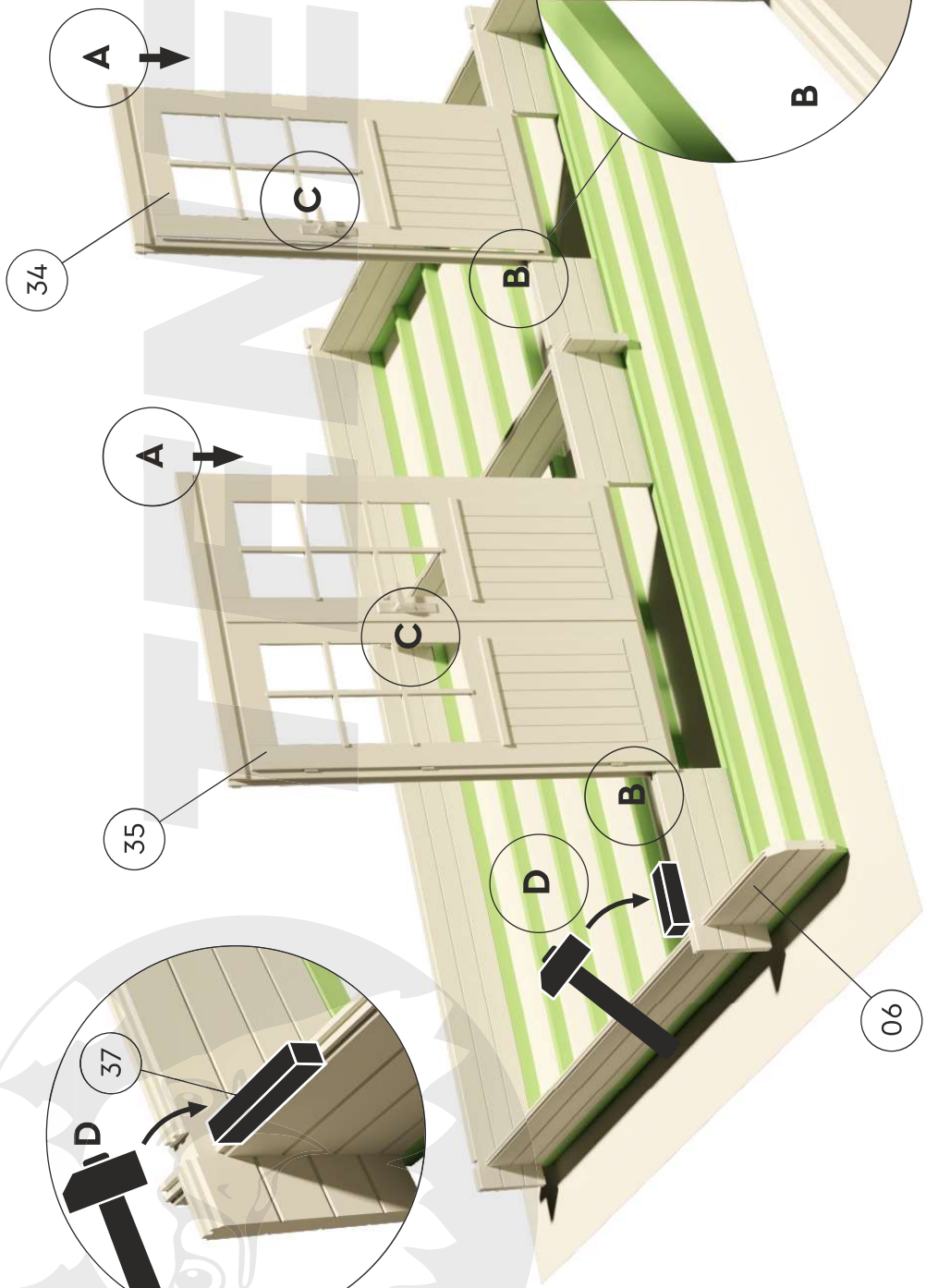
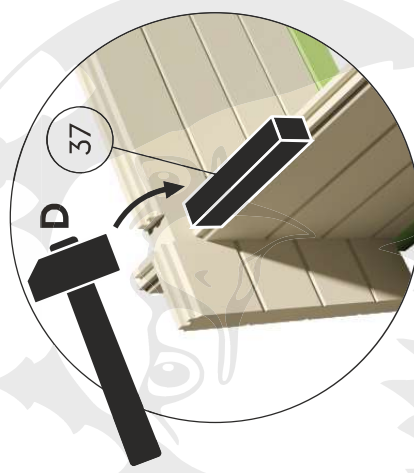
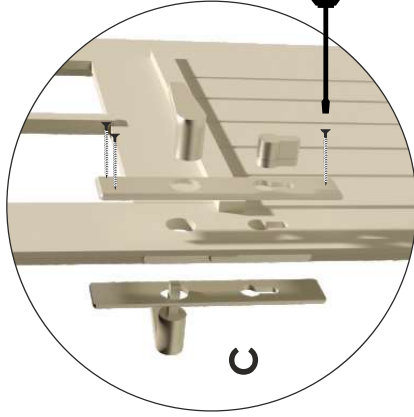
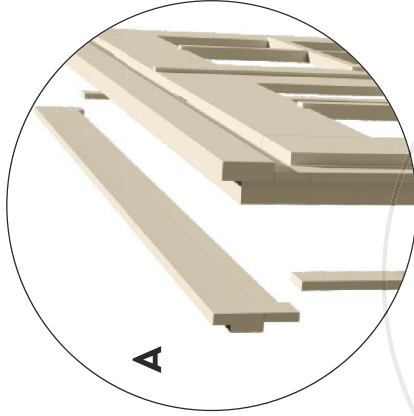

06

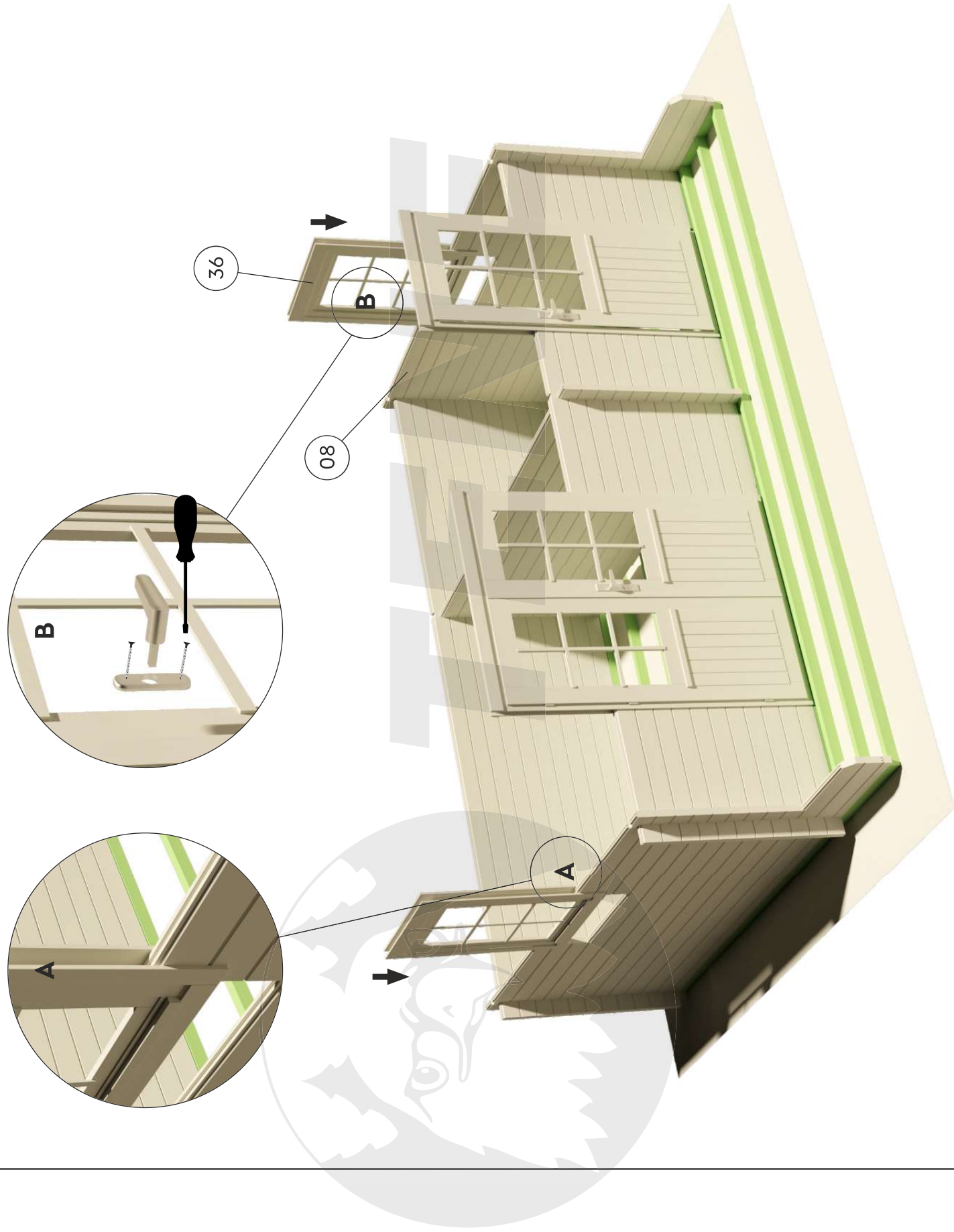



# ANNIKA 40



∅ 5 mm



6x140 mm

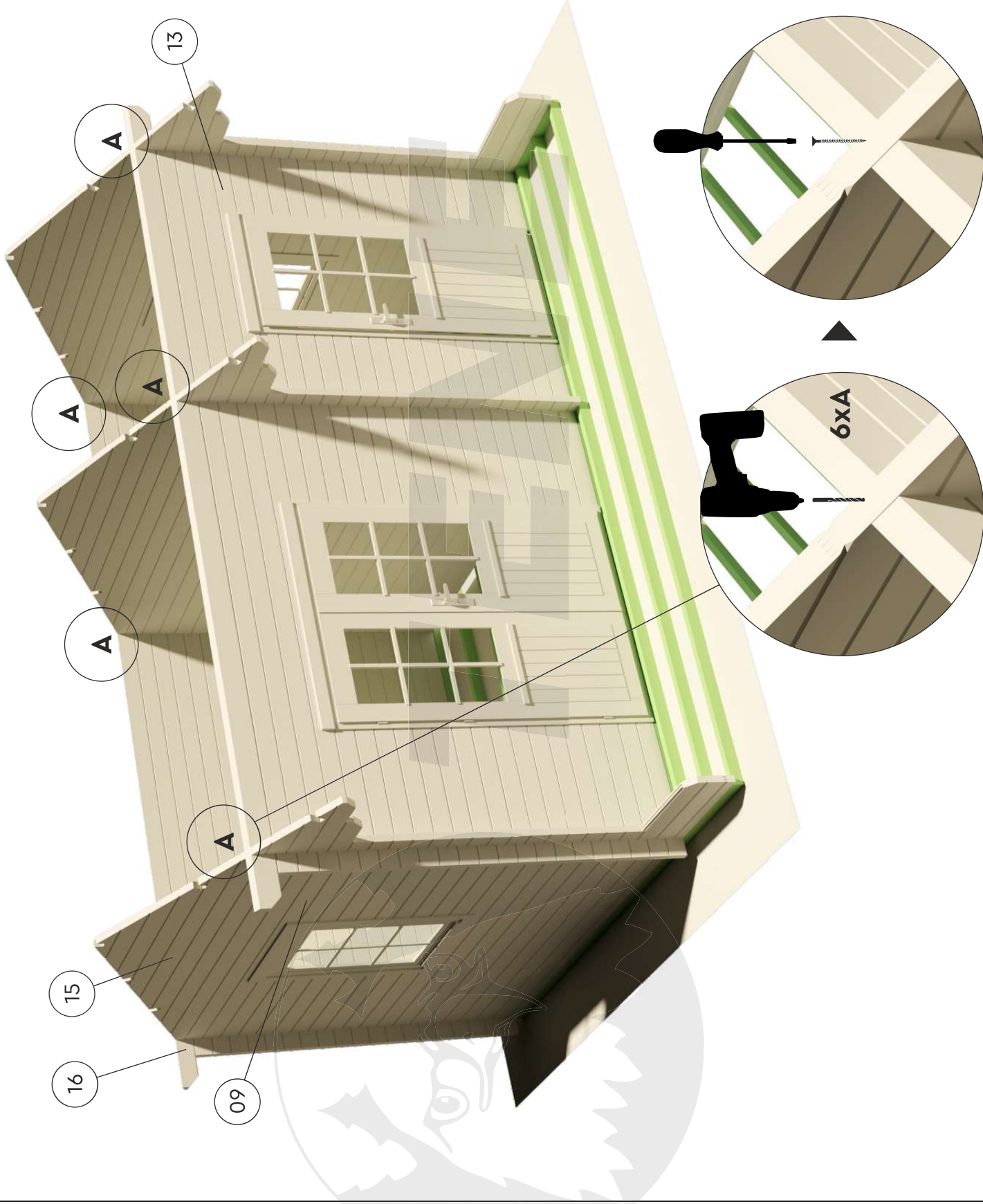

# ANNIKA 40



ø 5 mm



6x140 mm

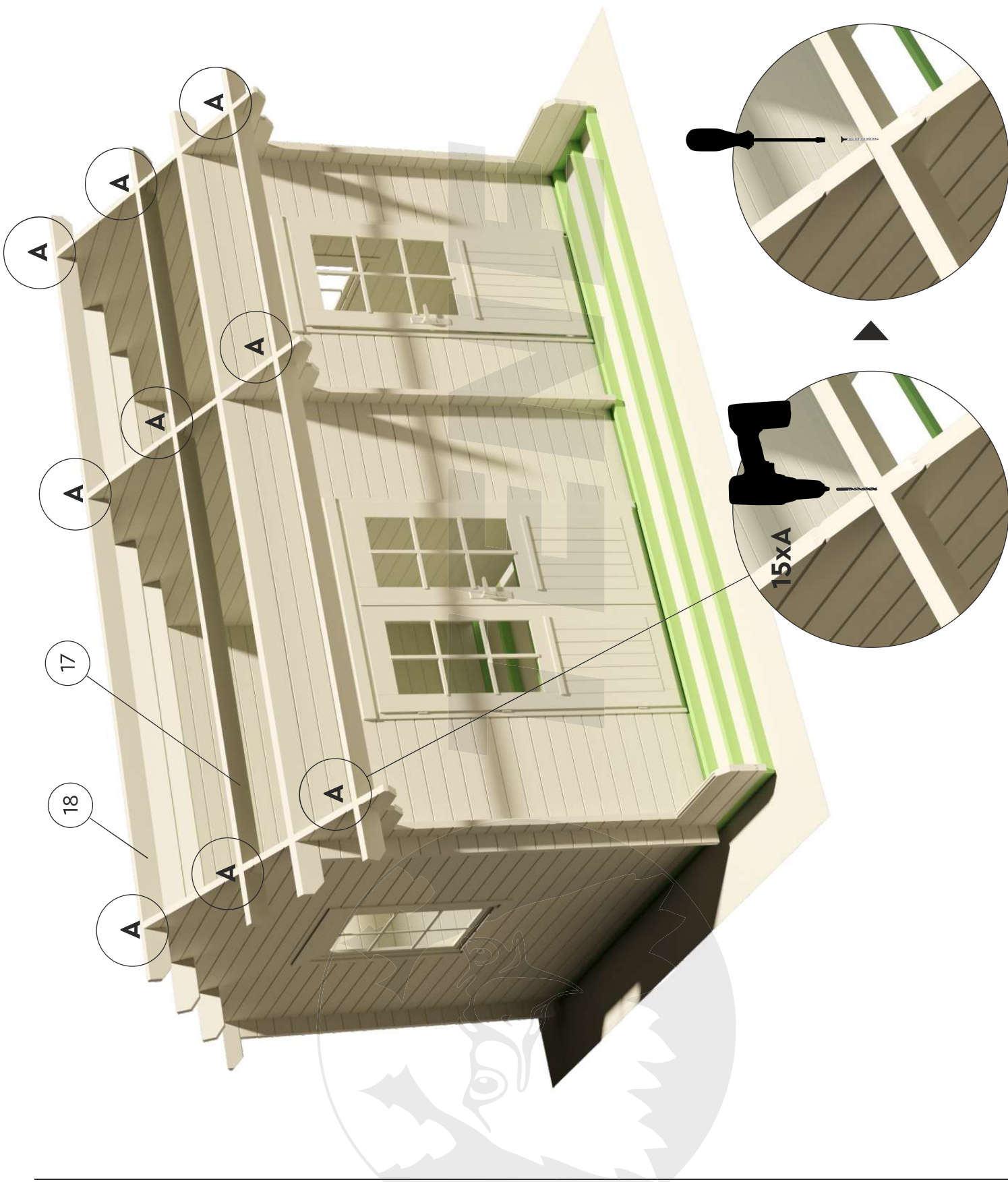



4x50 mm

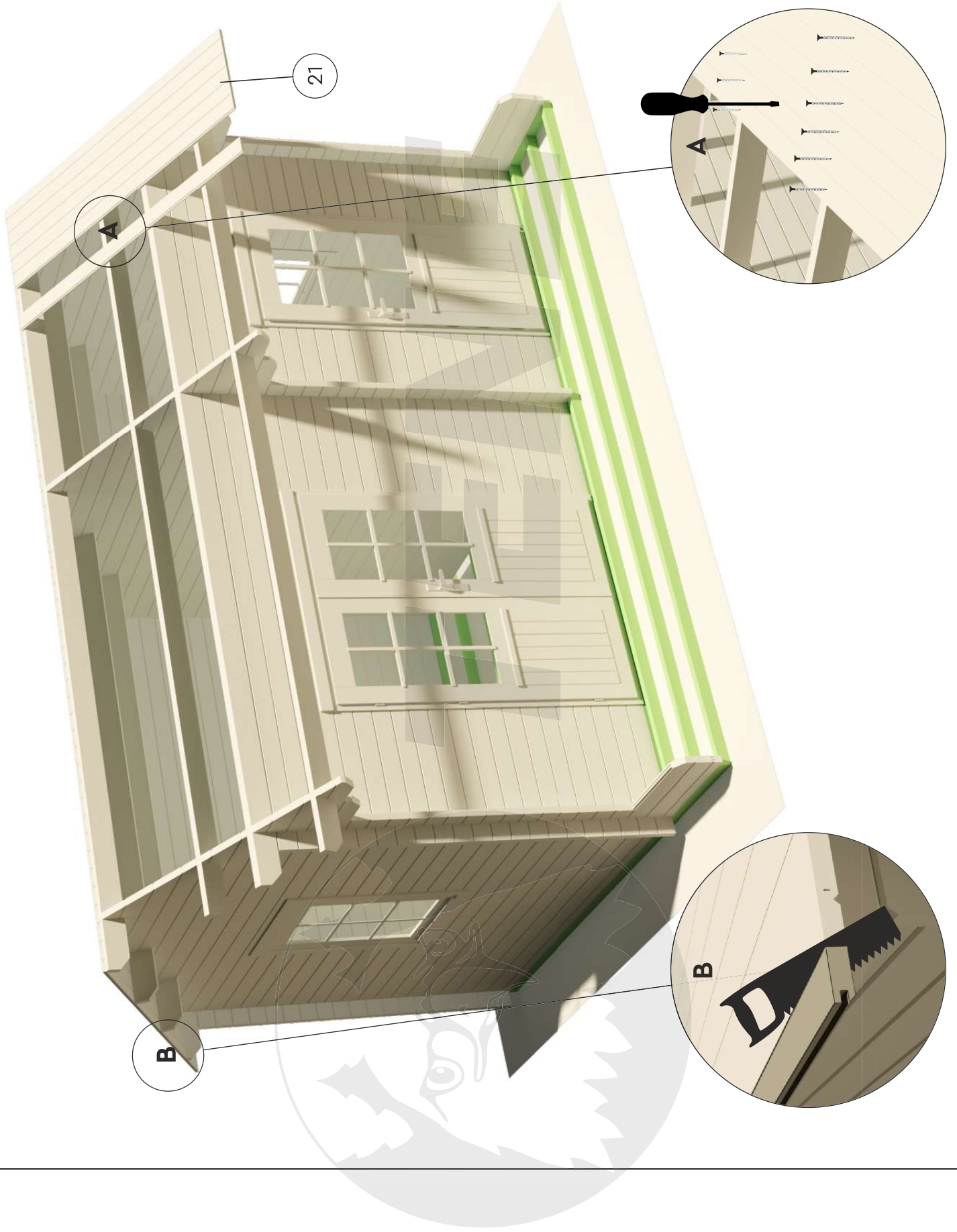

# ANNIKA 40



∅ 3 mm

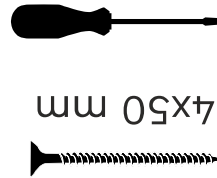

4x50 mm

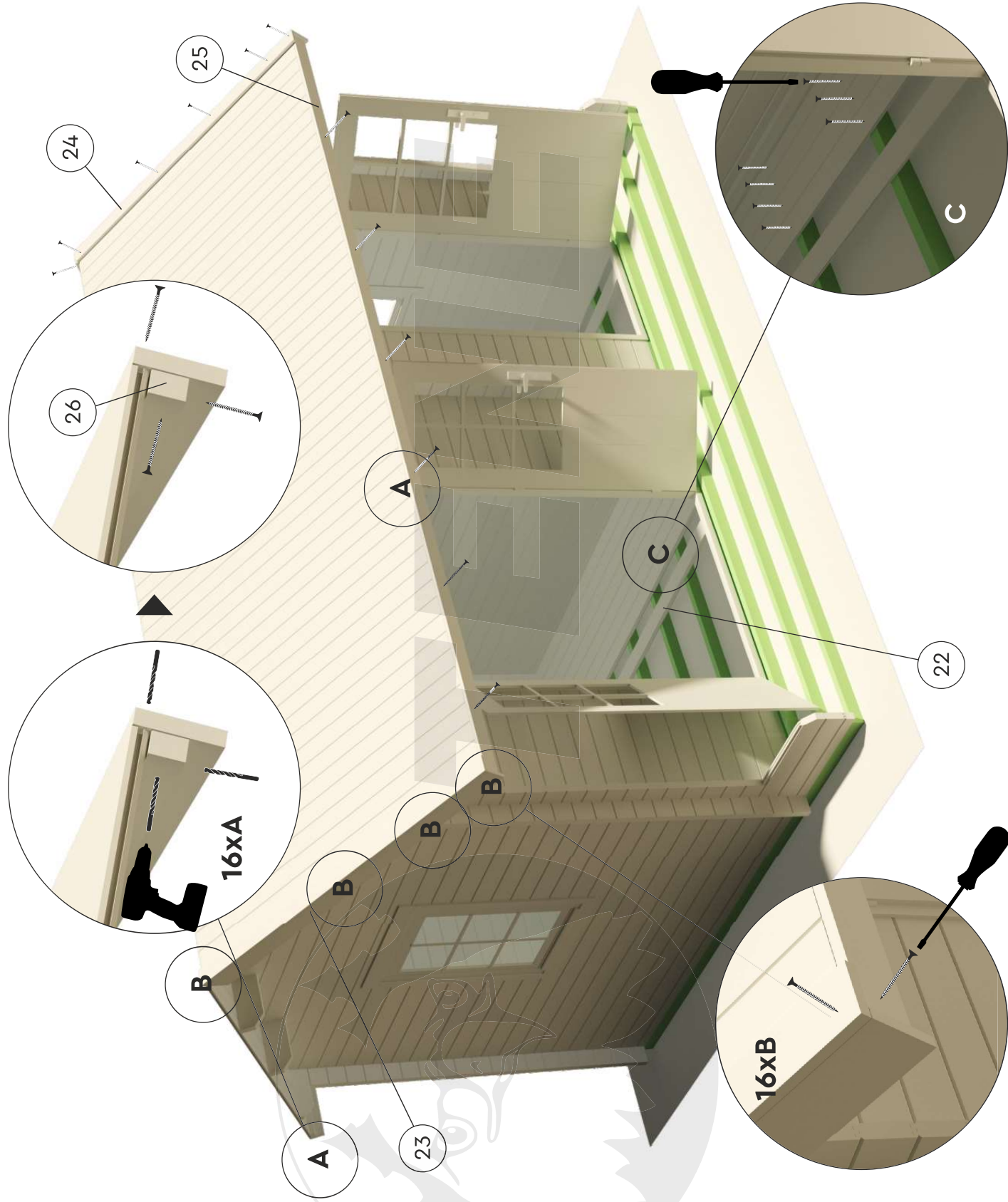

# ANNIKA 40



1,4x35 mm



4x50 mm

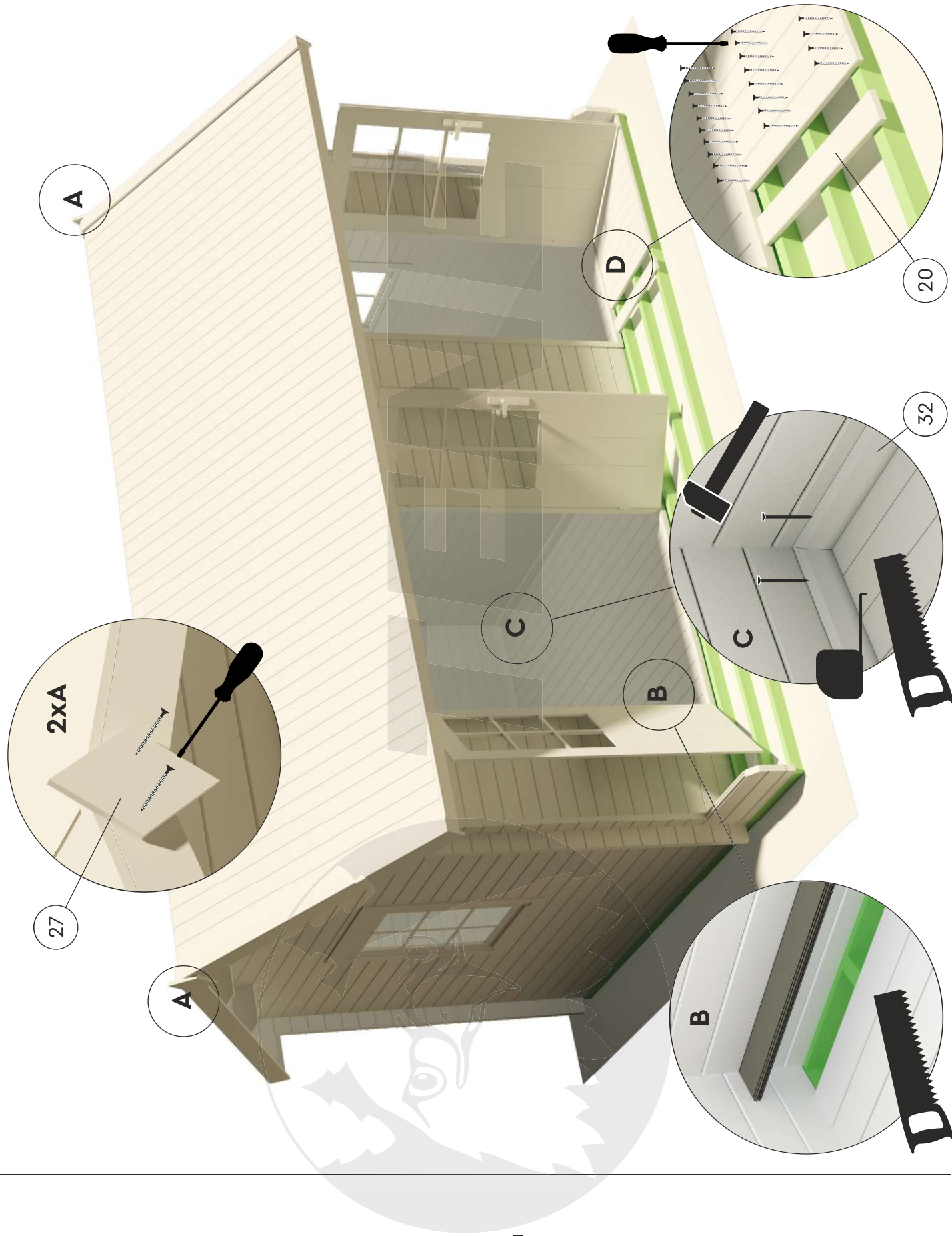

# ANNIKA 40

