

TIGRIS
Art.No. 701841

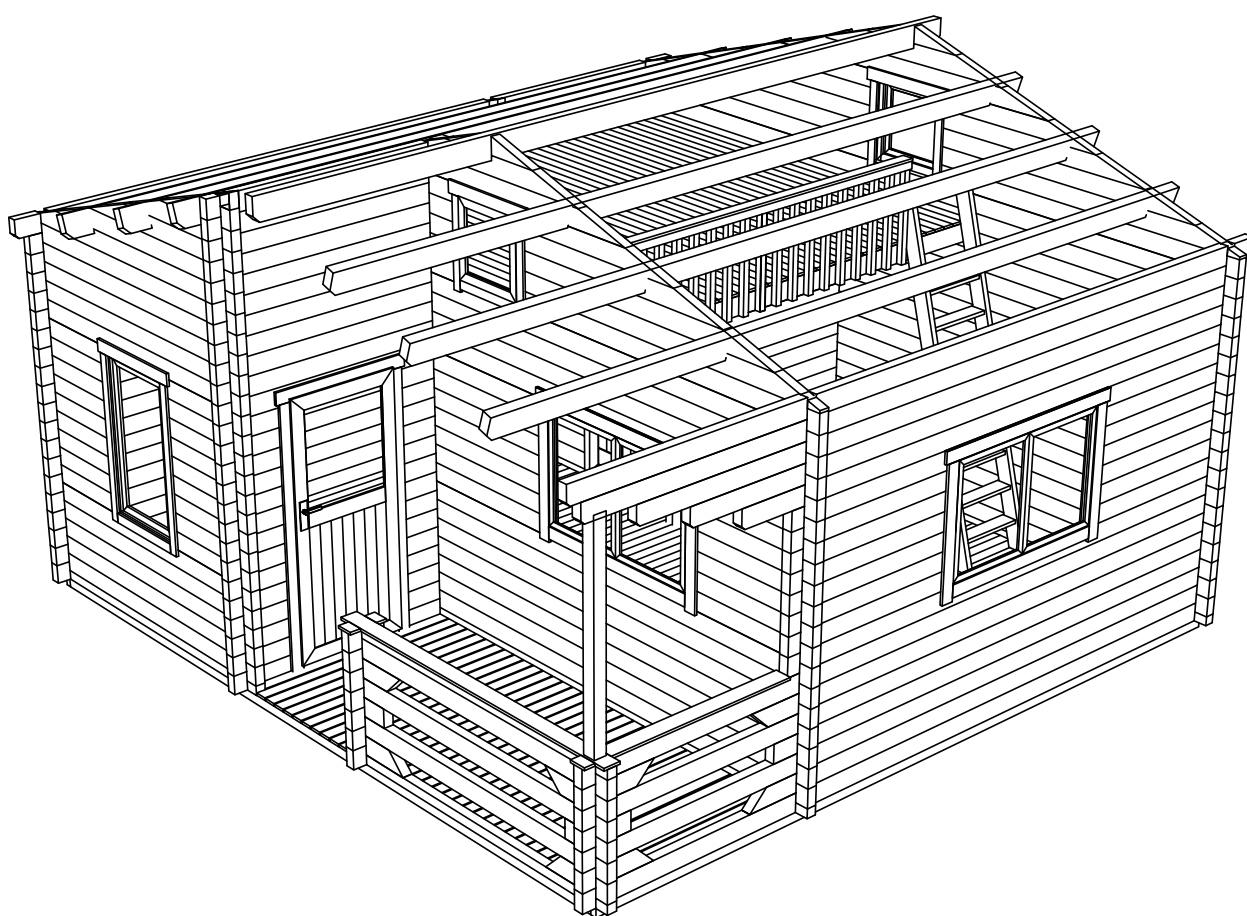

TIGRIS, Art.No.701802
GROUNDPLAN - GRUNDPLAN - PLAN DE MASSE

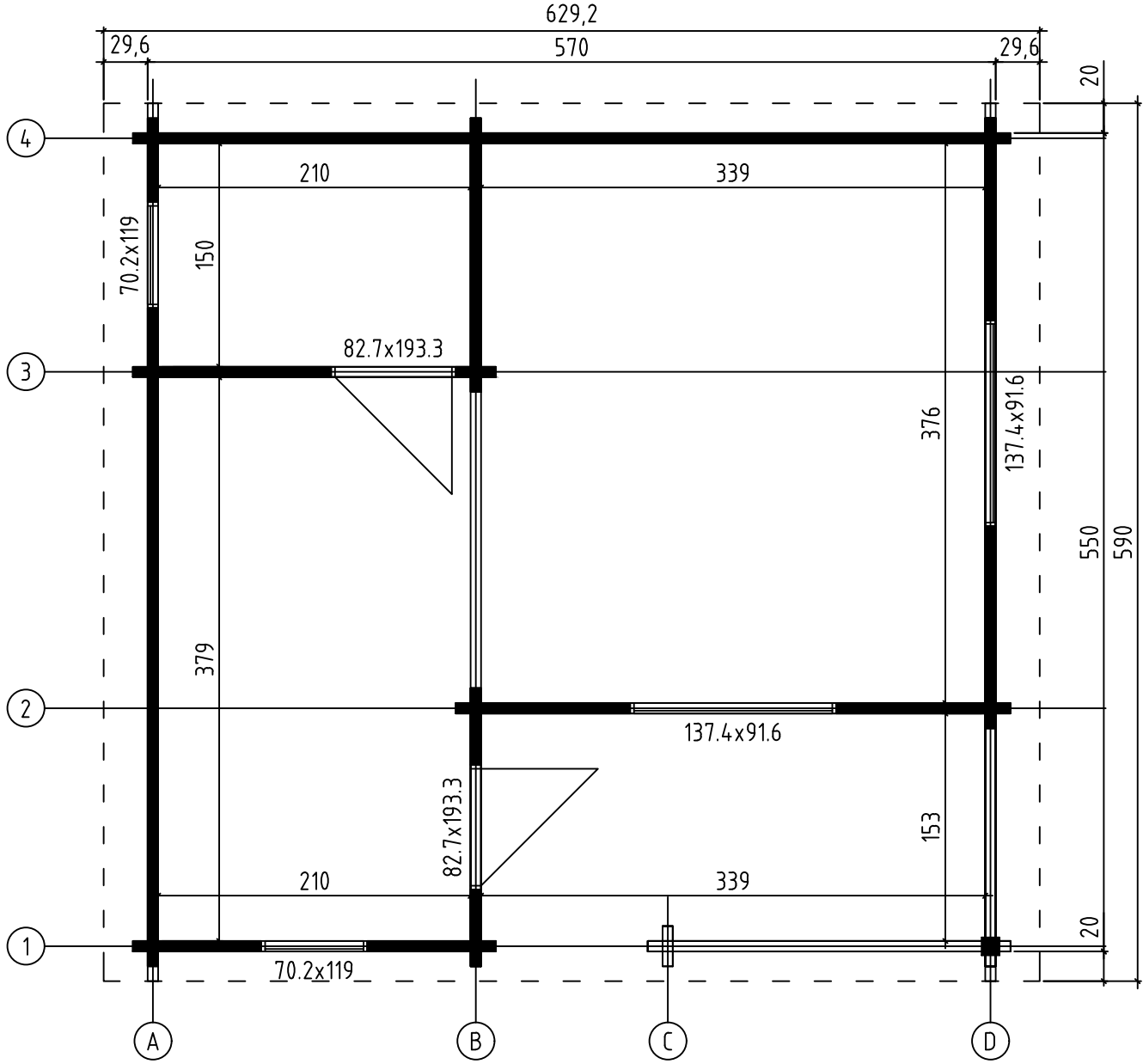

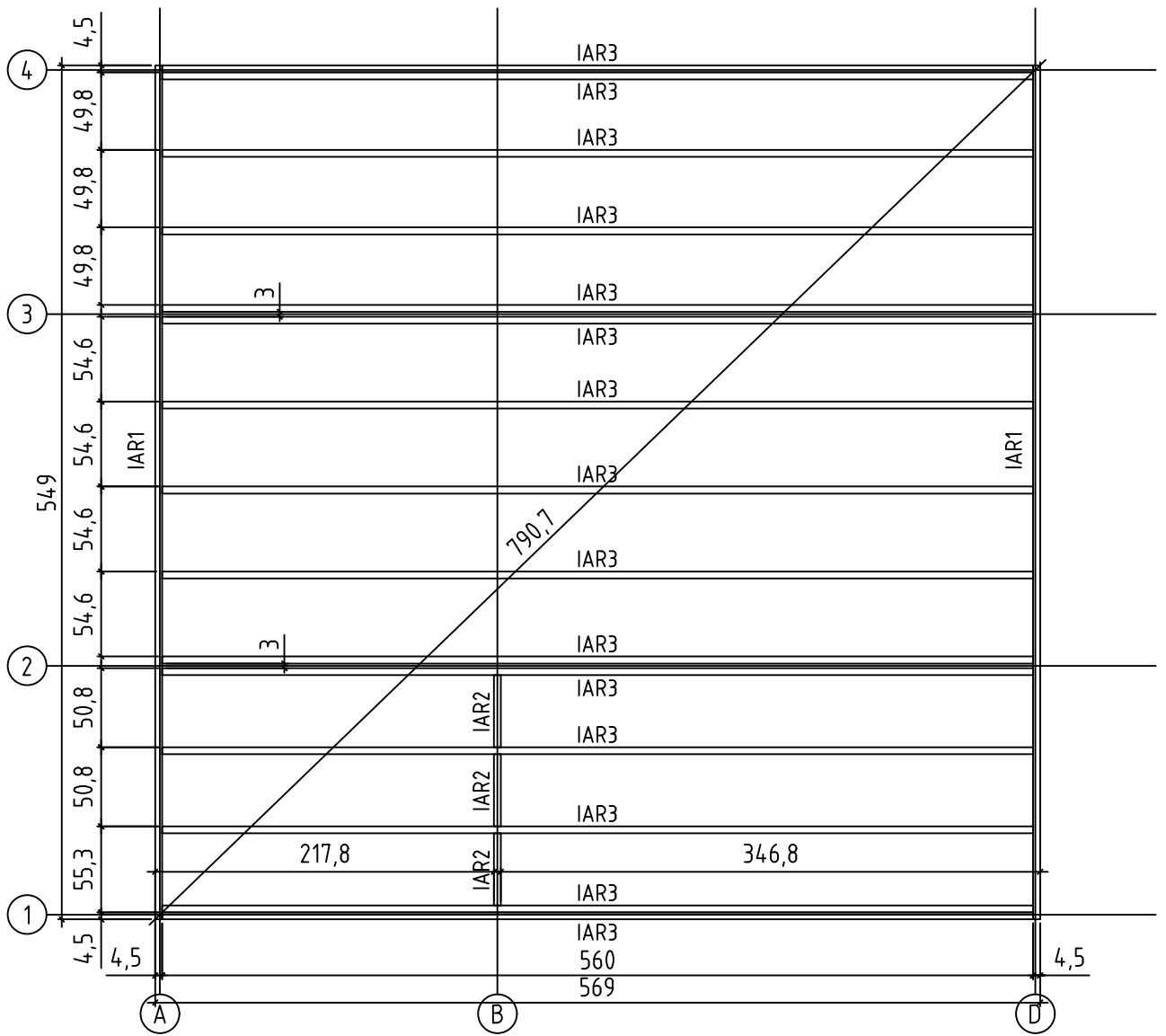

TIGRIS, Art.No.701802
FLOOR BEAMS - FUSSBODENBALKEN - SOLIVE(S) DE PLANCHER

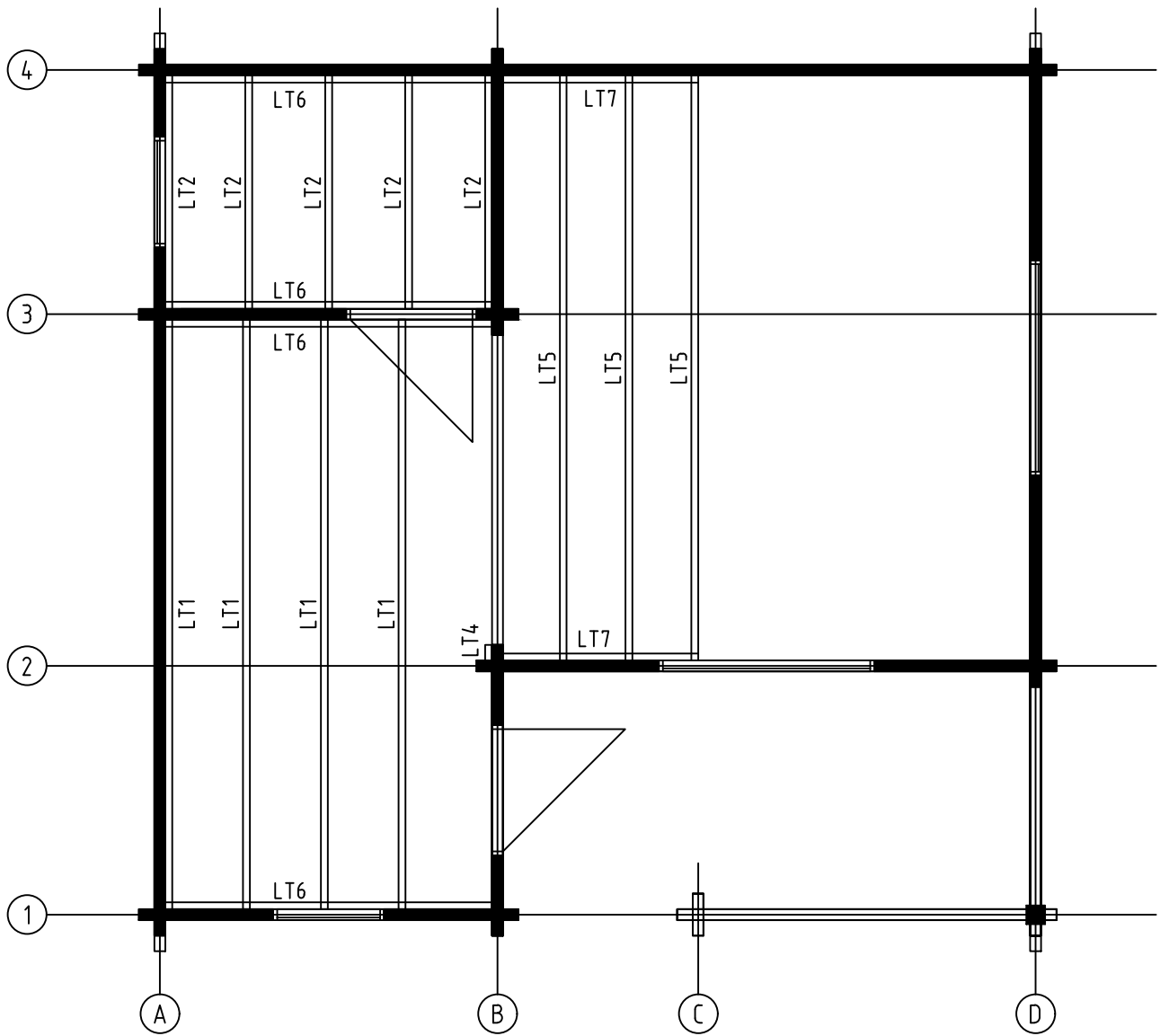

TIGRIS, Art.No.701802
FLOOR BOARDS - FUSSBODENBRETTER - PLAN POSE PLANCHER

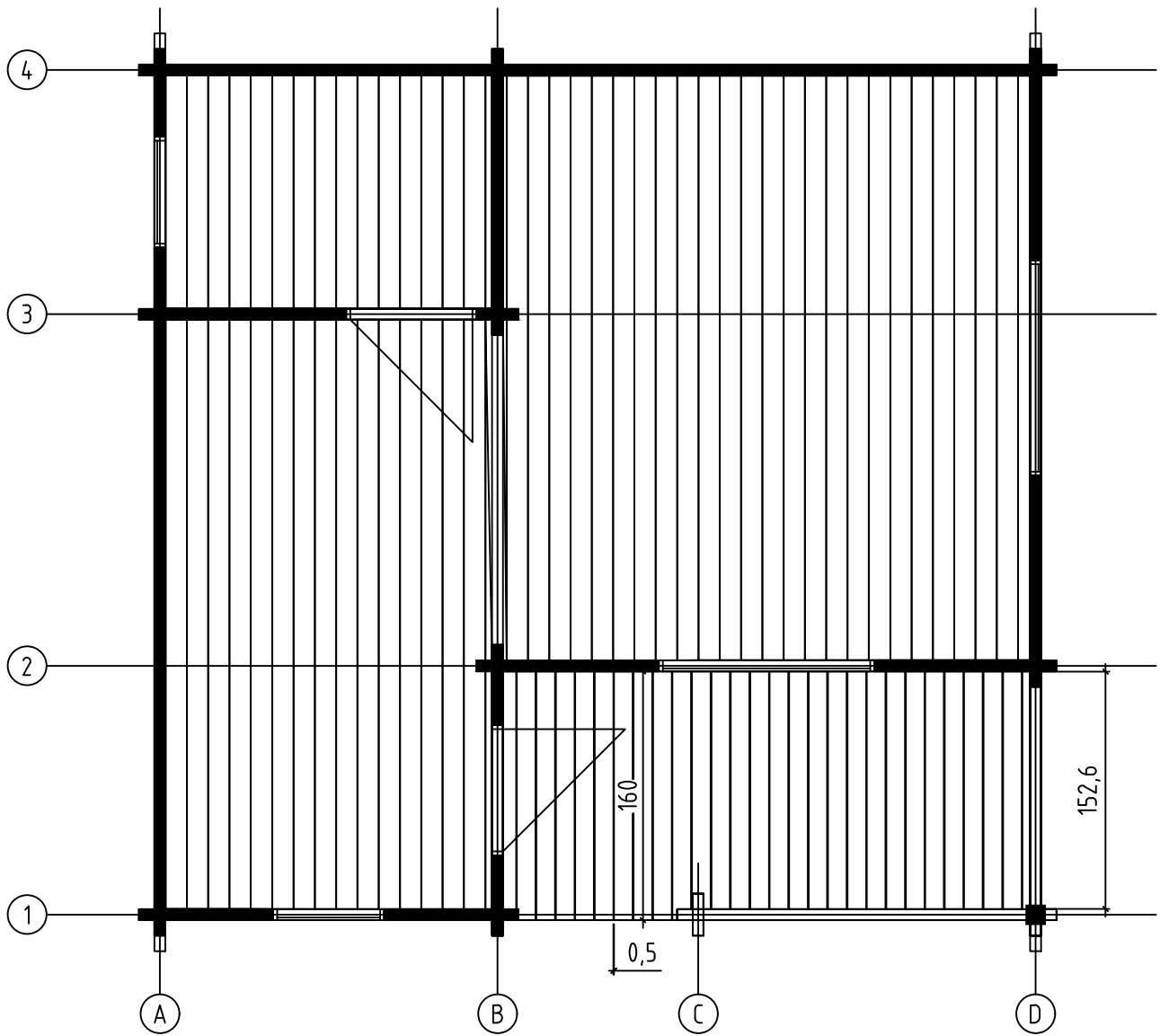

TIGRIS, Art.No.701802
FLOOR BOARDS - FUSSBODENBRETTER - PLAN POSE PLANCHER

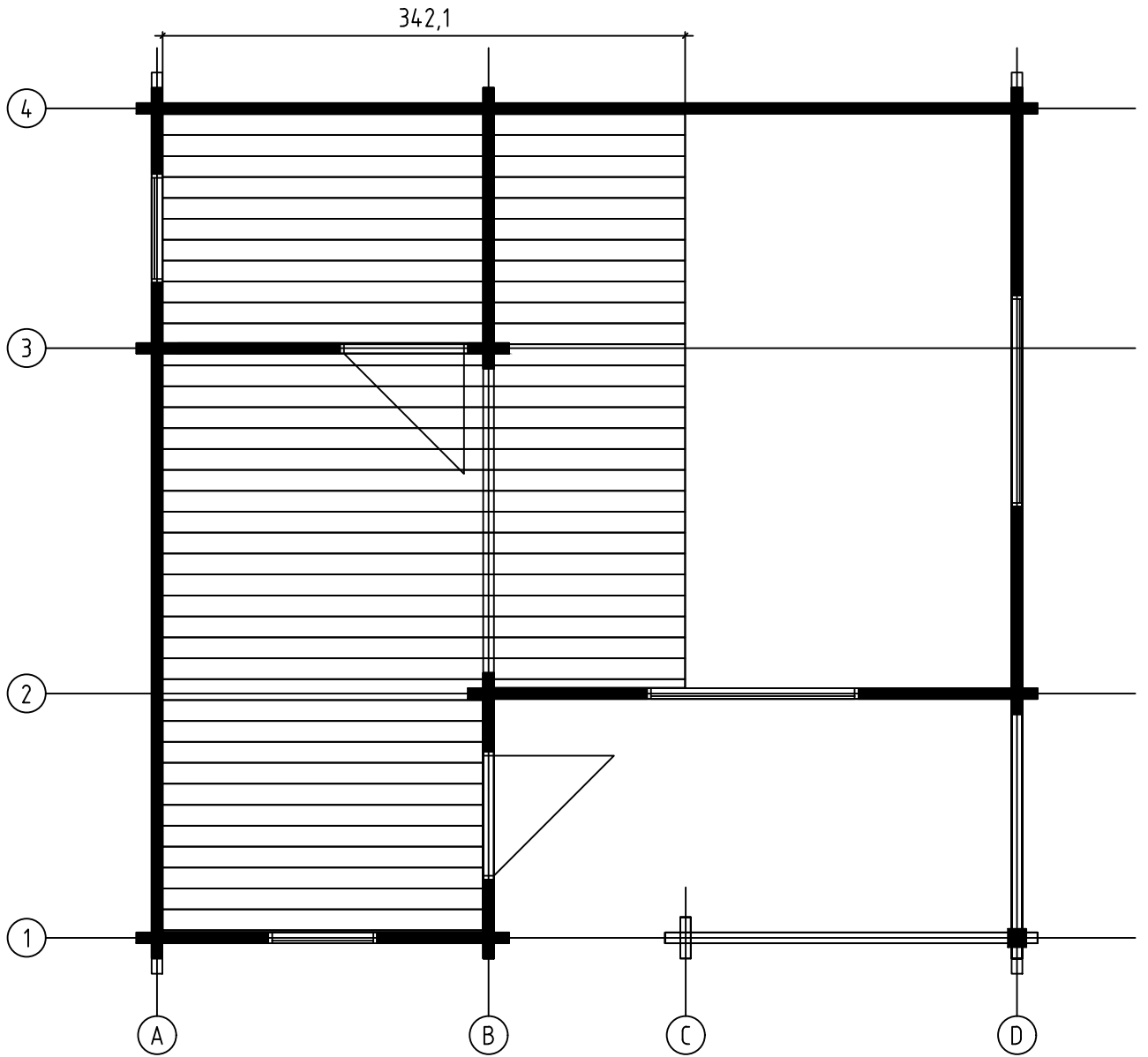

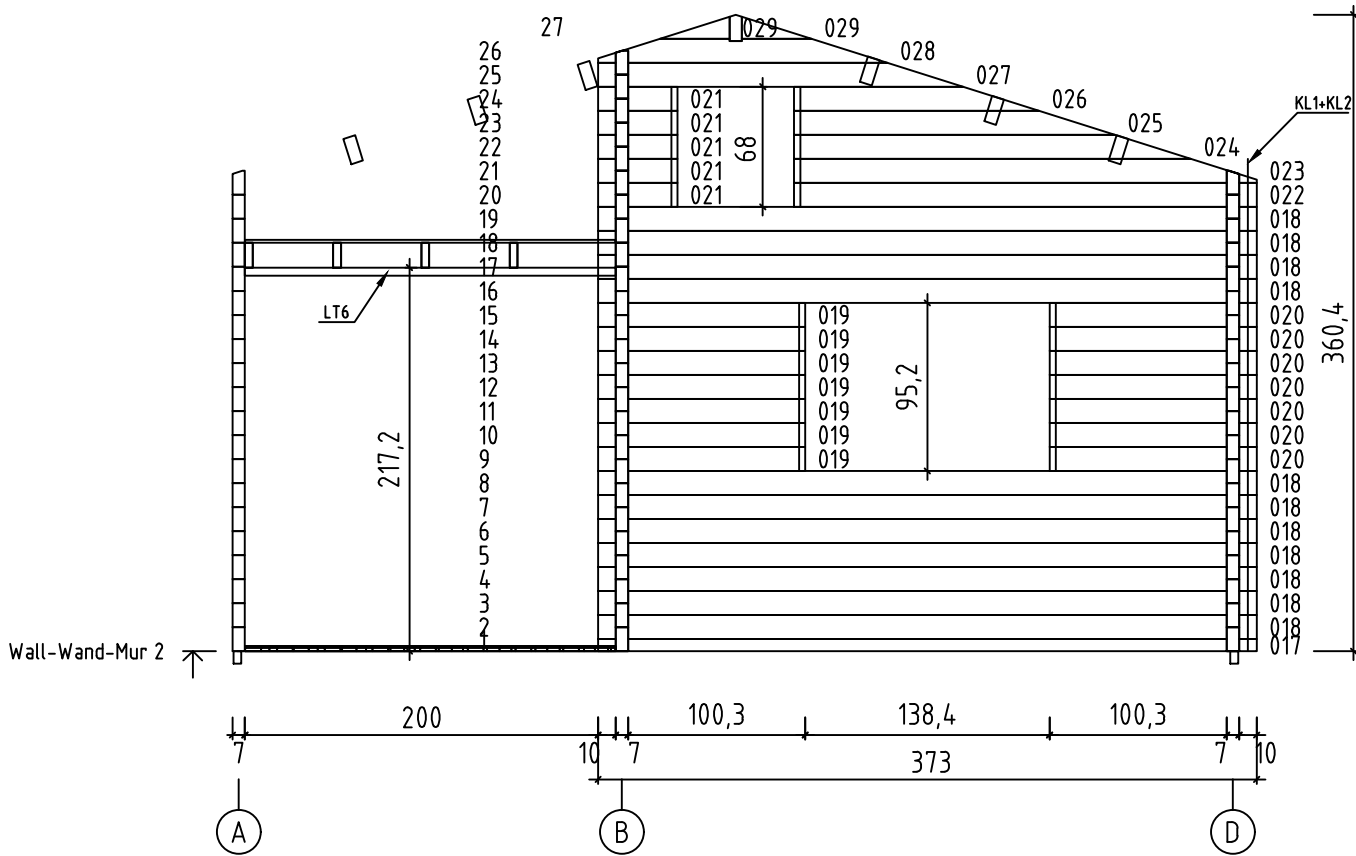
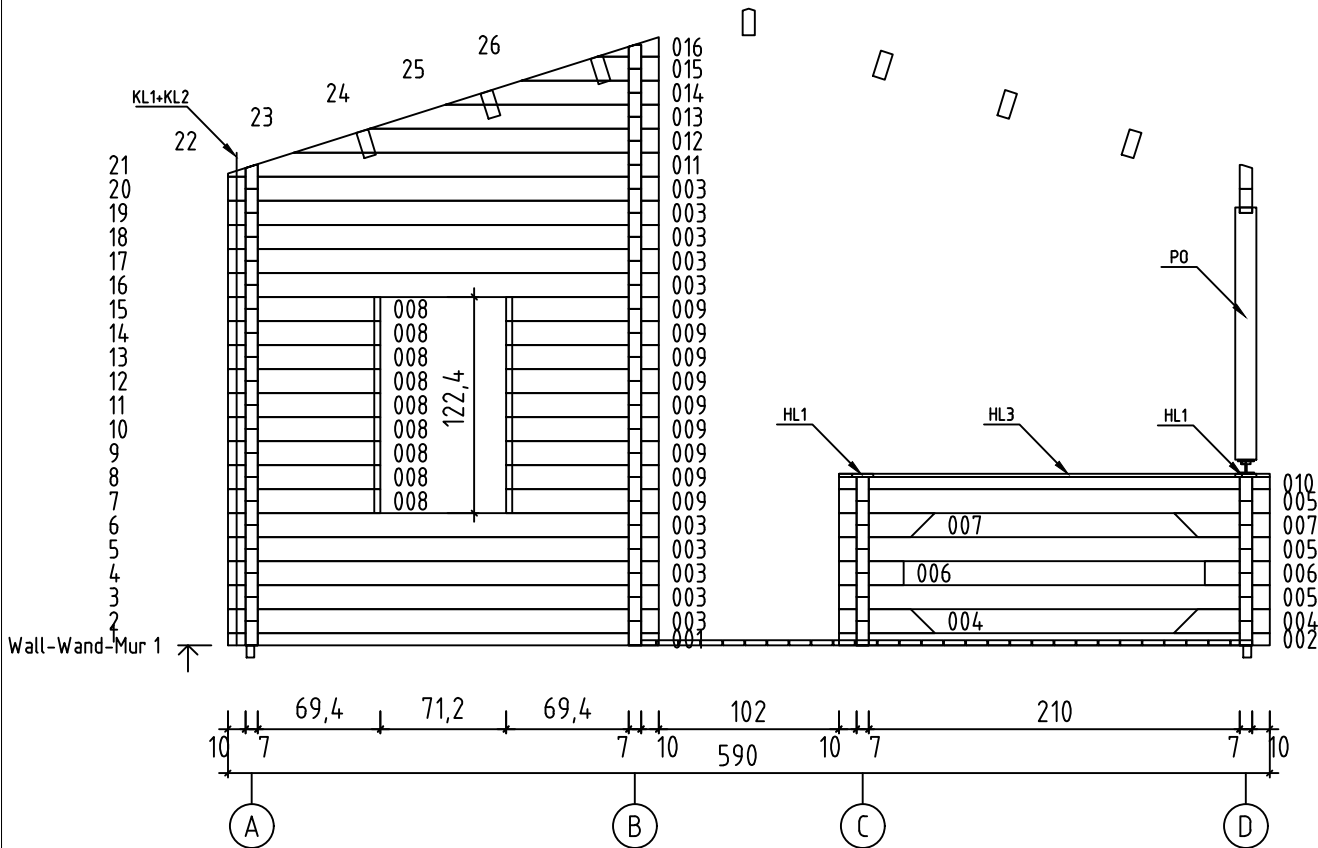

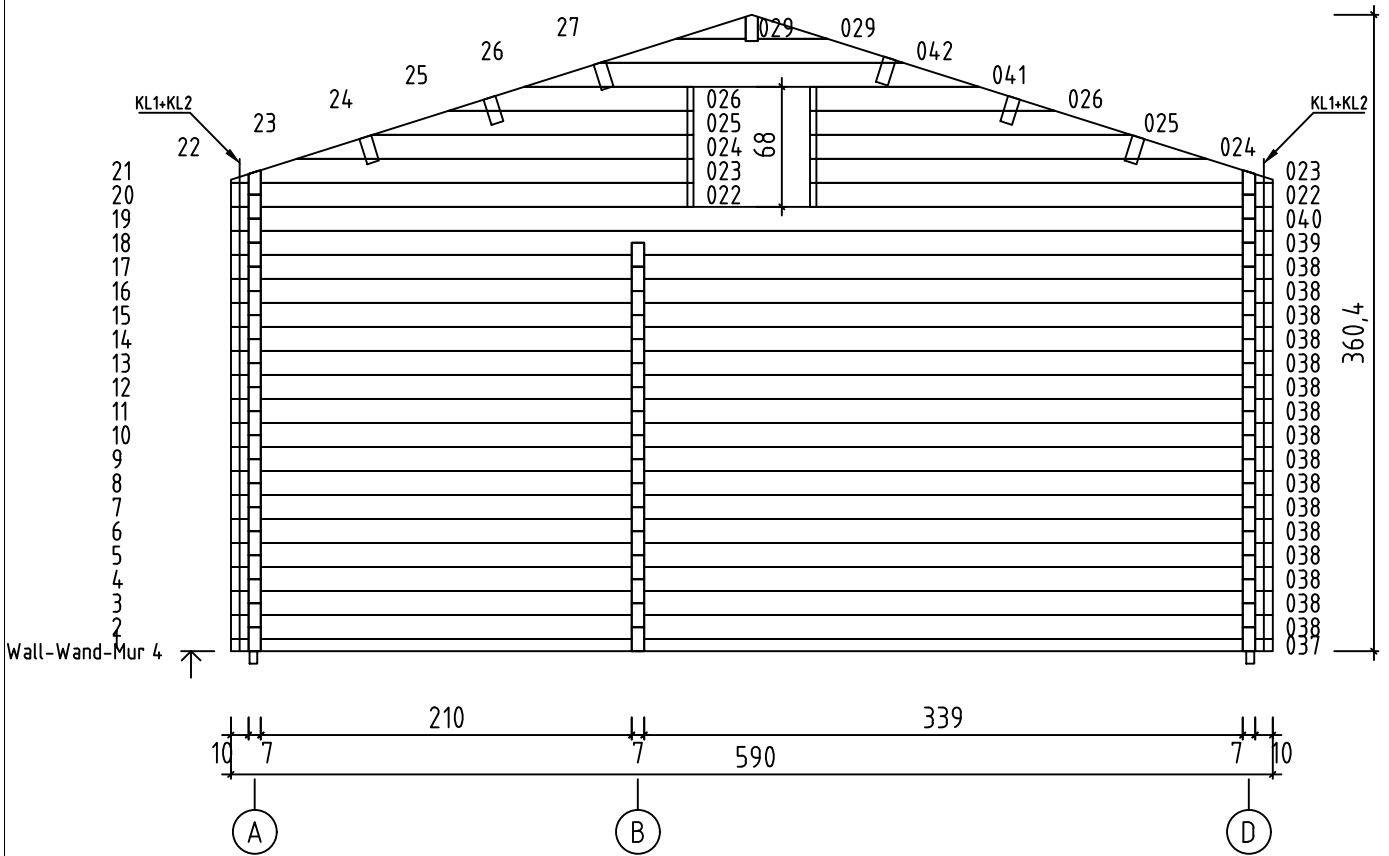
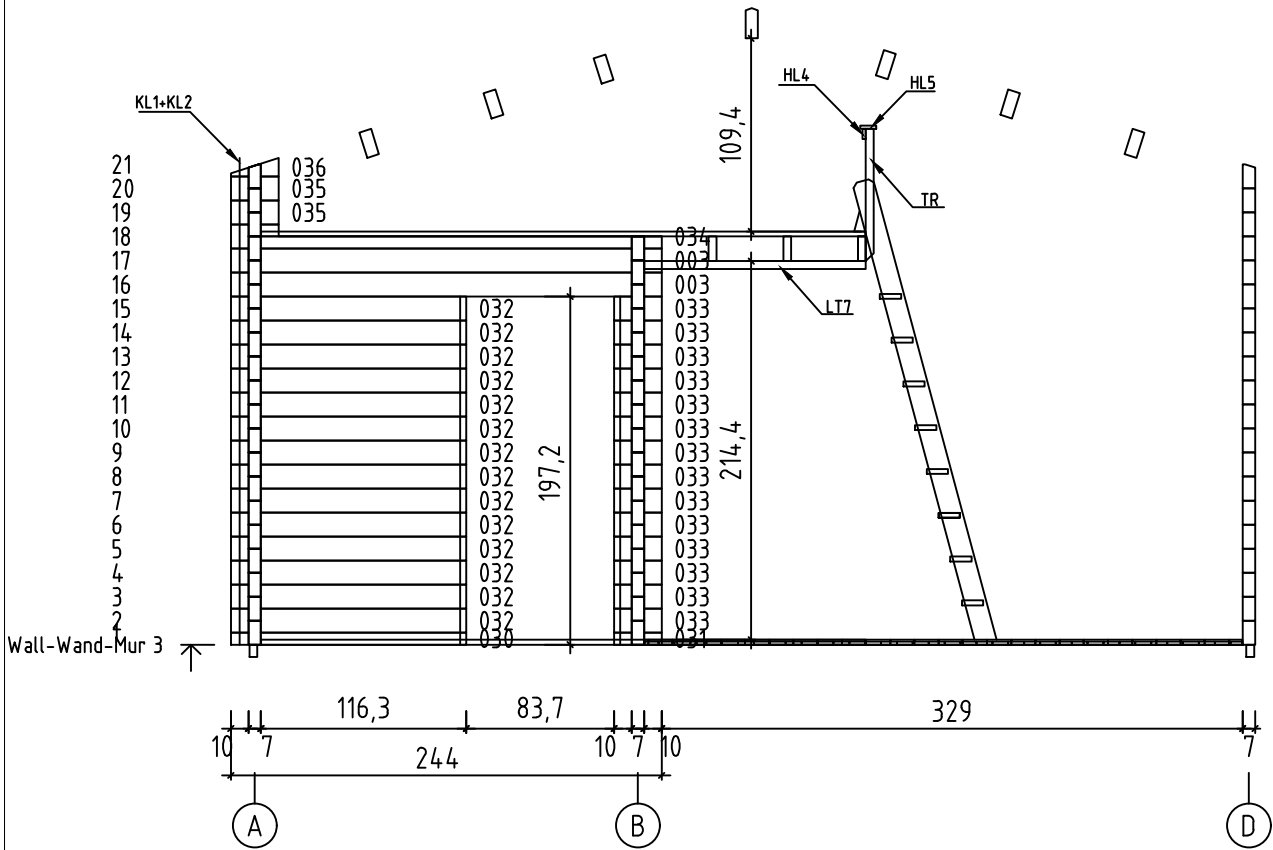

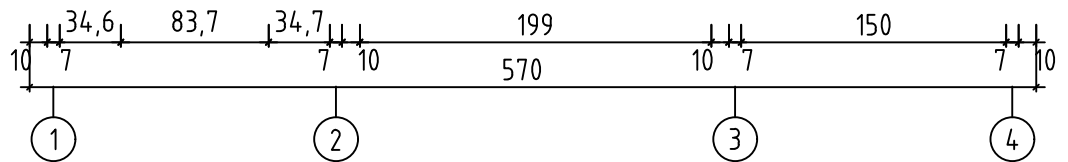
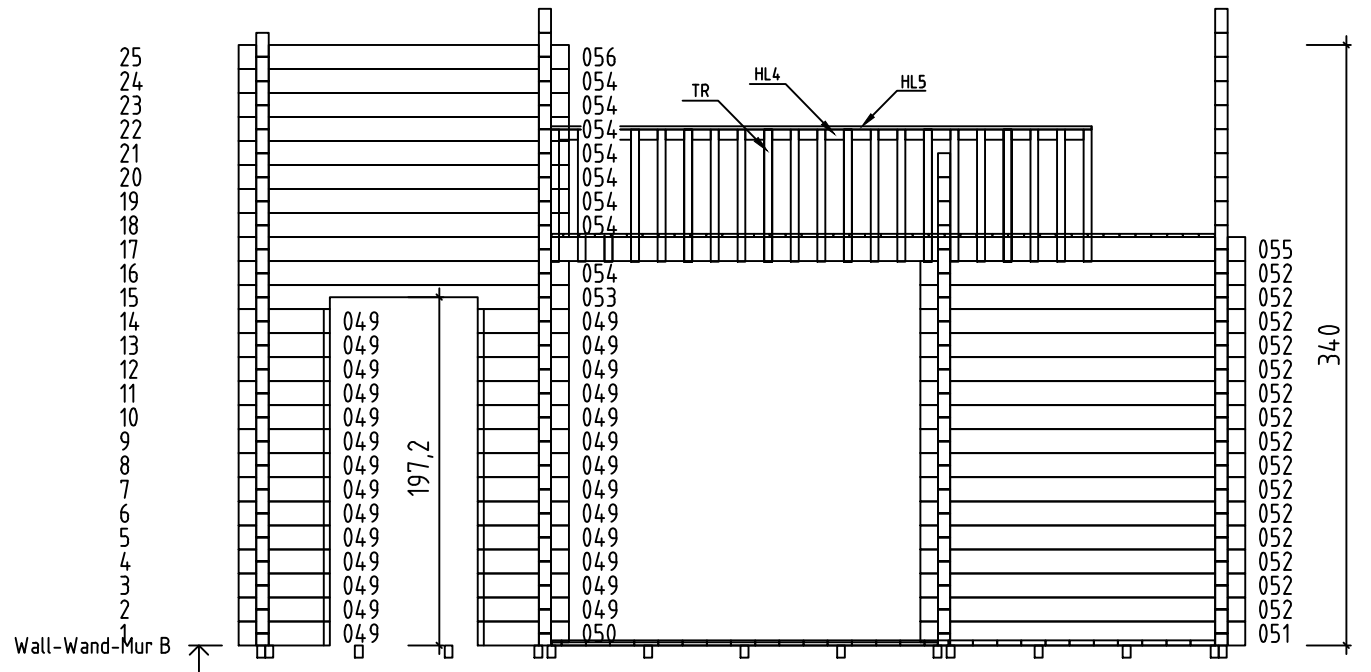
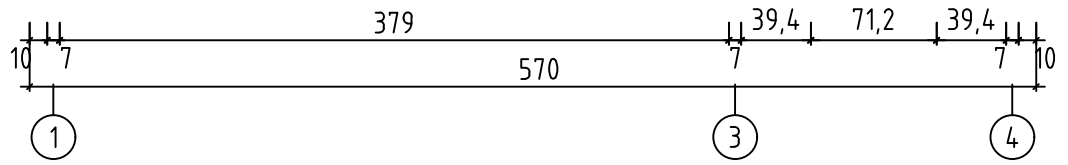
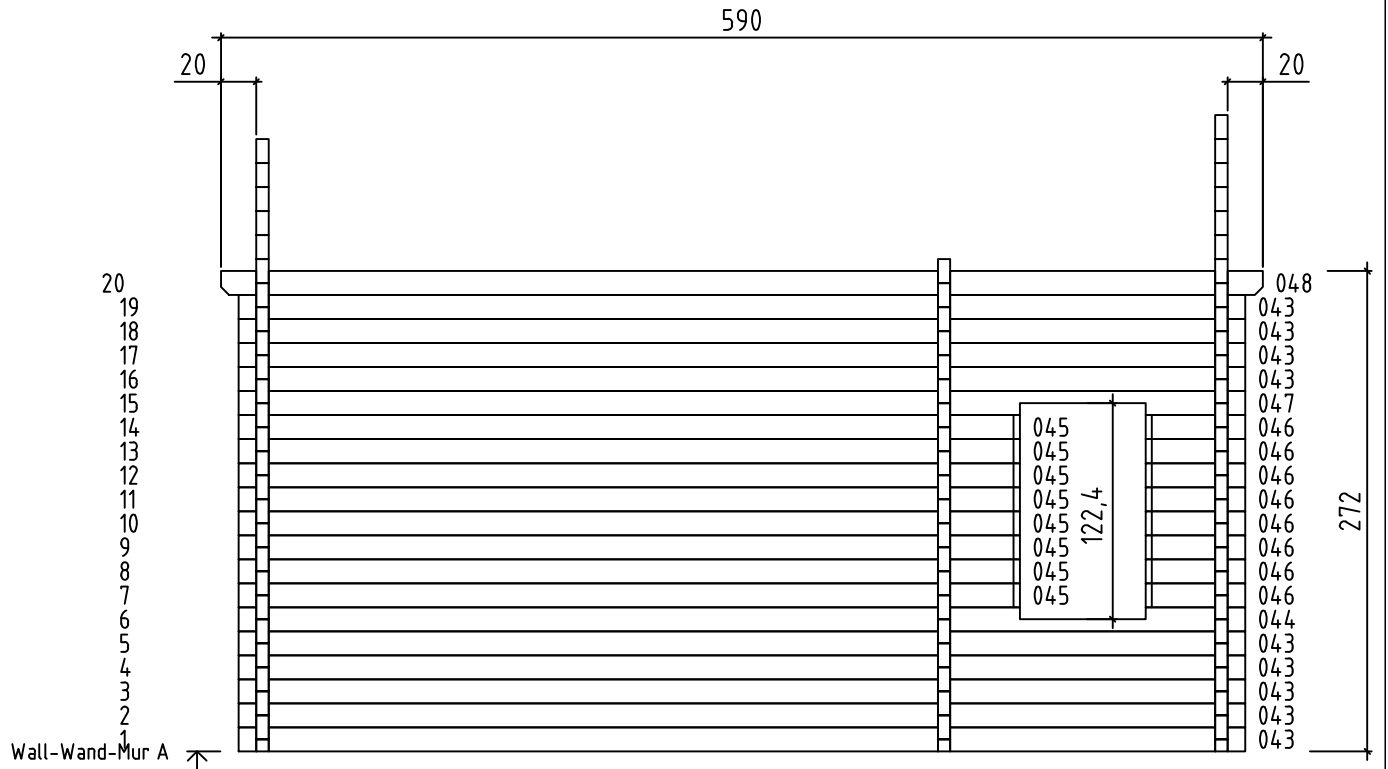

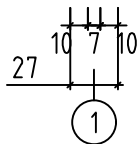
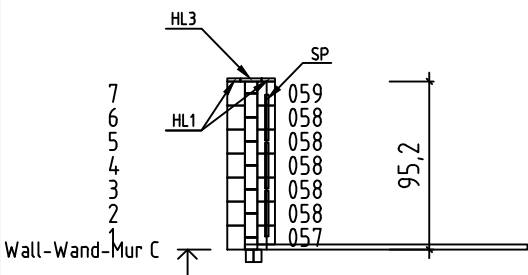
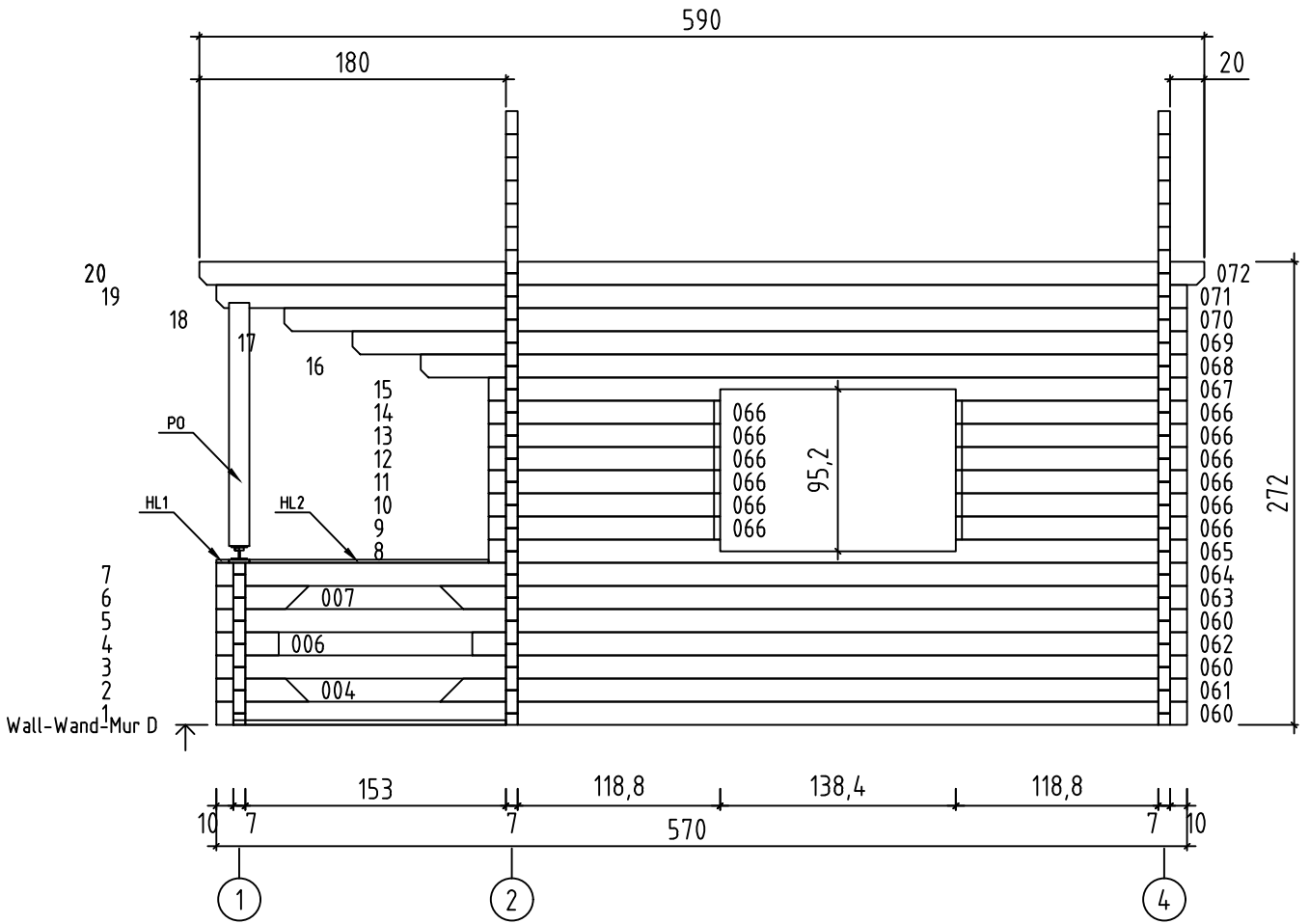

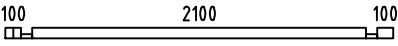
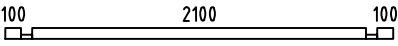
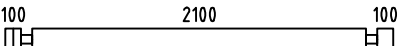

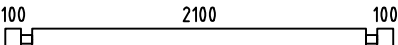

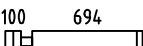
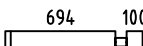
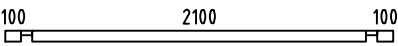
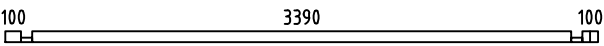
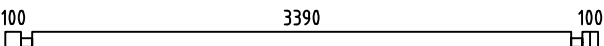
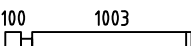
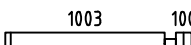

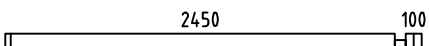
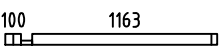

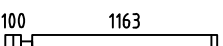

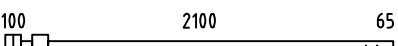

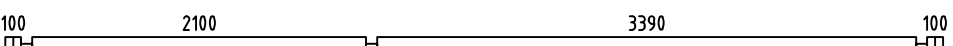
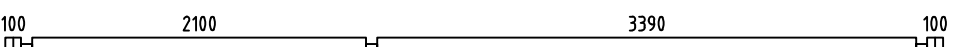

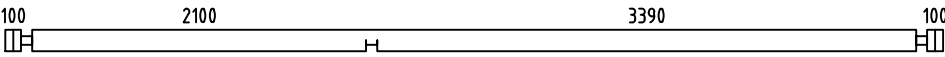
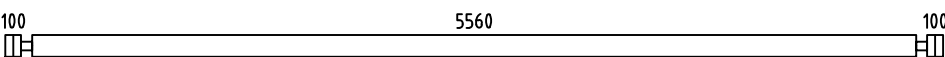
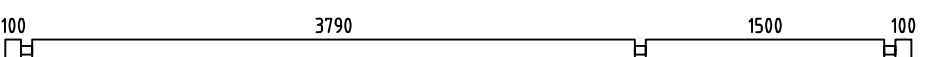
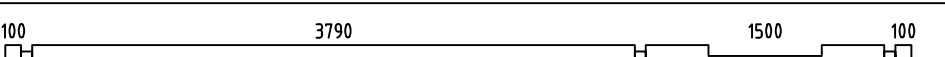
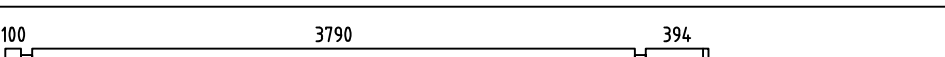
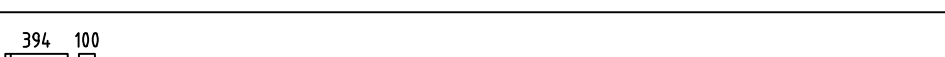
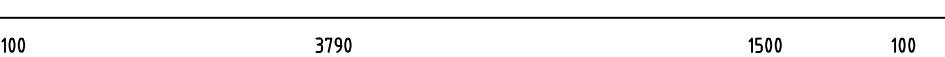
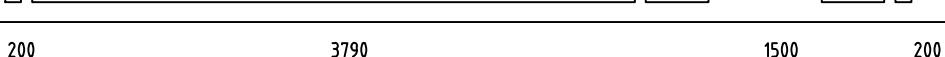
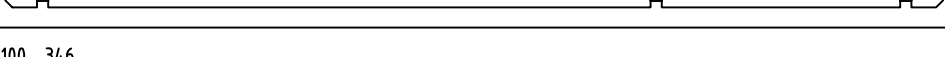
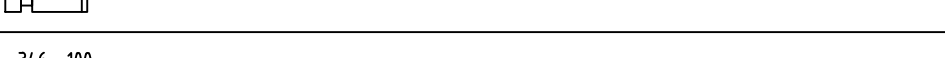
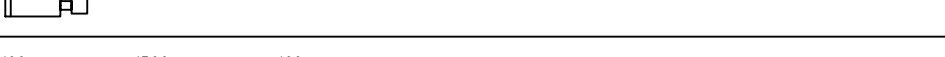
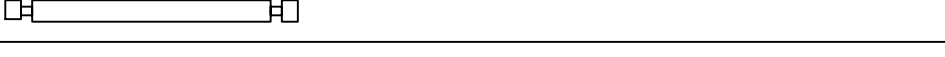
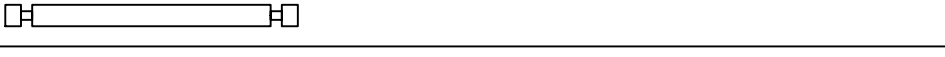
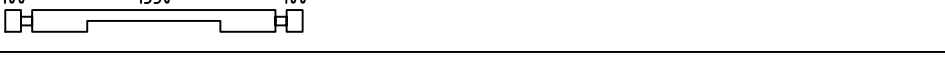

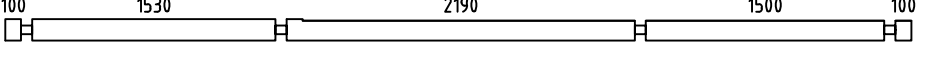



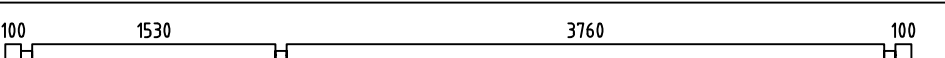
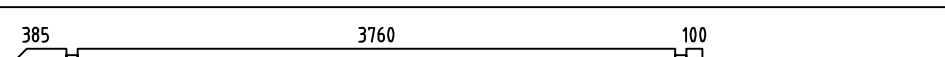
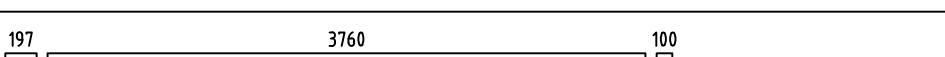
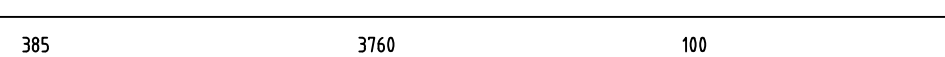
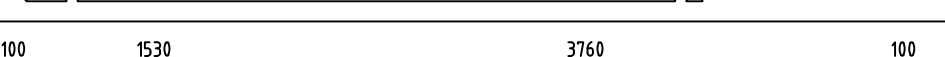

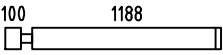
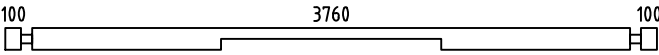
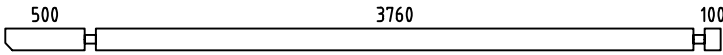
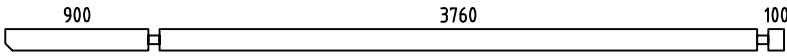
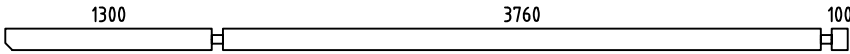
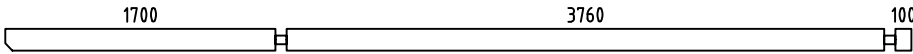
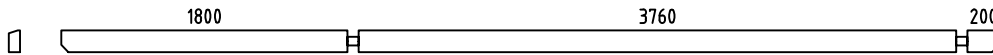
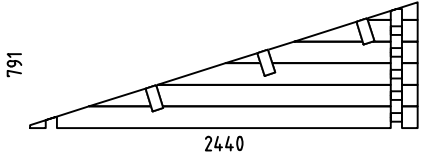
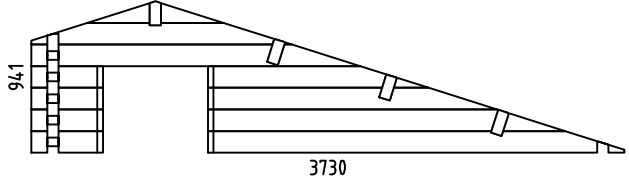
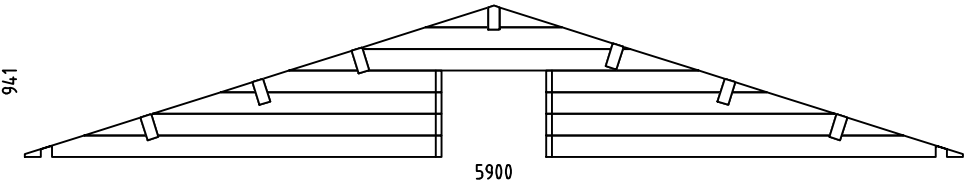

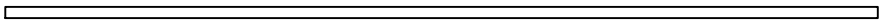

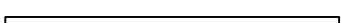
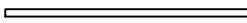

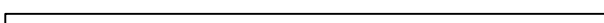
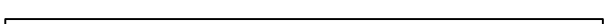





Pos	TIGRIS, Art.No.701802 Piece list - Stückliste - Liste des pieces	Q.	P (mm)	L (mm)
001		1	70x68	2440
002		1	70x68	2440
003		12	70x136	2440
004		3	70x136	542
005		3	70x136	2440
006		3	70x136	367
007		3	70x136	542
008		9	70x136	864
009		9	70x136	864
010		1	70x68	2440
017		1	70x68	3730
018		11	70x136	3730
019		7	70x136	1173
020		7	70x136	1173
021		1	70x136	450
022		3	70x136	2620
030		1	70x68	1333
031		1	70x68	270
032		14	70x136	1333
033		14	70x136	270
034		1	70x136	2440
035		2	70x136	270
036		1	70x104	270
037		1	70x68	5900
038		16	70x136	5900

Pos	TIGRIS, Art.No.701802 Piece list - Stückliste - Liste des pieces	Q.	P (mm)	L (mm)
039		1	70x136	5900
040		1	70x136	5900
043		9	70x136	5700
044		1	70x136	5700
045		8	70x136	4424
046		8	70x136	564
047		1	70x136	5700
048		1	70x136	5900
049		27	70x136	516
050		1	70x136	516
051		1	70x136	1840
052		15	70x136	1840
053		1	70x136	1870
054		8	70x136	1870
055		1	70x136	5700
056		1	70x136	1870
057		1	70x136	270
058		5	70x136	270
059		1	70x136	270
060		3	70x136	5700
061		1	70x136	4385
062		1	70x136	4197
063		1	70x136	4385
064		1	70x136	5700
065		1	70x136	4100

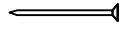
Pos	TIGRIS, Art.No.701802 Piece list - Stückliste - Liste des pieces	Q.	P (mm)	L (mm)
066		12	70x136	1358
067		1	70x136	4100
068		1	70x136	4500
069		1	70x136	4900
070		1	70x136	5300
071		1	70x136	5700
072		1	70x136	5900
W1-1		1		
W2-1		1		
W4-1		1		
IAR3	FOUNDATION - FUNDAMENT - FONDATION 	15	45x70	5600
IAR1	FOUNDATION - FUNDAMENT - FONDATION 	2	45x70	5490
IAR2	FOUNDATION - FUNDAMENT - FONDATION 	3	45x70	463
LT6	RIDGE BOARD - DACHPFETTEN - FA?TAGE 	4	45x45	2100
LT3	RIDGE BOARD - DACHPFETTEN - FA?TAGE 	1	45x45	1530
LT7	RIDGE BOARD - DACHPFETTEN - FA?TAGE 	2	45x45	1255
LT4	RIDGE BOARD - DACHPFETTEN - FA?TAGE 	1	45x45	100
LT1	RIDGE BOARD - DACHPFETTEN - FA?TAGE 	4	44x140	3790
LT5	RIDGE BOARD - DACHPFETTEN - FA?TAGE 	3	44x140	3760
LT2	RIDGE BOARD - DACHPFETTEN - FA?TAGE 	5	44x140	1500

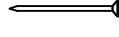
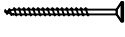
Pos	TIGRIS, Art.No.701802 Piece list - Stückliste - Liste des pieces	Q.	P (mm)	L (mm)
PR11	ROOF BEAM - DACHBALKEN - PANNE DE TOIT 3760	1	70x170	5900
PR23	ROOF BEAM - DACHBALKEN - PANNE DE TOIT 3760	3	70x170	5900
PR21	ROOF BEAM - DACHBALKEN - PANNE DE TOIT 3790	1	70x170	5900
PR22	ROOF BEAM - DACHBALKEN - PANNE DE TOIT 5360	2	70x170	5900
	FLOOR BOARDS - FUSSBODENBRETTER - LAME DE PLANCHER 137x28		137x28	303 m.
	ROOF BOARDS - DACHBRETTER - VOLIGES 90x18	132	90x18	3300
	TERRACE BOARDS - TERRASSENBRETTER - PLANCHER DE TERRASSE 28x120	10	28x120	1600
	TERRACE BOARDS - TERRASSENBRETTER - PLANCHER DE TERRASSE 28x120	18	28x120	1526
	FLOOR FILLET-FUSSBODENLEISTE - CORNIERE DE FINITION DU PLANCHER 18x18		18x18	46.5 m.
DPL	ROOFING FELT FILLET - DACHPAPPENLEISTE - BAGUETTE DE FIXATION DU FEUTRE BITUMEUX 18x58	4	18x58	3350
KL1	TREADED ROD M12 - GEWINDESTANGE M12 - TIGE FILETÉE M12 5	5		716
KL2	TREADED ROD M12 - GEWINDESTANGE M12 - TIGE FILETÉE M12 5	5		2000
PO	POST - PFOSTEN - POTEAU 1	1	120x120	1430
TB	EAVES BOARD - TRAUFBRETT - BANDEAU DE TOIT 18x90	2	18x90	5900
DRV	ROOF EDGE REINFORCEMENT - DACHRANDVERSTÄRKUNG - CORNIERE DE RENFORT DE BORD DE TOIT 28x34	4	28x34	2950
TBE6	FIXING FILLET FOR WINDOW - FIXIRUNGSLEISTE FÜR FENSTER - PROFIL DE FIXATION DES FENETRES 28x34	4	28x34	650
TBE6	FIXING FILLET FOR WINDOW - FIXIRUNGSLEISTE FÜR FENSTER - PROFIL DE FIXATION DES FENETRES 28x34	2	28x34	748
TBE6	FIXING FILLET FOR WINDOW - FIXIRUNGSLEISTE FÜR FENSTER - PROFIL DE FIXATION DES FENETRES 28x34	2	28x34	916
TBE6	FIXING FILLET FOR WINDOW - FIXIRUNGSLEISTE FÜR FENSTER - PROFIL DE FIXATION DES FENETRES 28x34	2	28x34	1020
TBE6	FIXING FILLET FOR WINDOW - FIXIRUNGSLEISTE FÜR FENSTER - PROFIL DE FIXATION DES FENETRES 28x34	2	28x34	1190
TBE6	FIXING FILLET FOR DOOR - FIXIRUNGSLEISTE FÜR TÜR - PROFIL DE FIXATION DES PORTES 28x34	2	28x34	1836
TBE6	FIXING FILLET FOR DOOR - FIXIRUNGSLEISTE FÜR TÜR - PROFIL DE FIXATION DES PORTES 28x34	2	28x34	1933
TR	TERRACE RAILING - TERRASSE - GARDE-CORPS DE TERRASSE 45x45	20	45x45	750
HL1	GUARD-RAIL FOR TERRACE - TERRASSEN GELÄNDER - MAIN COURANTE DE TERRASSE 18x120	3	18x120	75
HL2	GUARD-RAIL FOR TERRACE - TERRASSEN GELÄNDER - MAIN COURANTE DE TERRASSE 18x120	1	18x120	1405

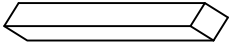
Pos	TIGRIS, Art.No.701802 Piece list - Stückliste - Liste des pieces	Q.	P (mm)	L (mm)
HL3	GUARD-RAIL FOR TERRACE - TERRASSEN GELÄNDER - MAIN COURANTE DE TERRASSE 	1	18x120	2445
HL4	GUARD-RAIL FOR TERRACE - TERRASSEN GELÄNDER - MAIN COURANTE DE TERRASSE 	1	18x58	3060
HL5	GUARD-RAIL FOR TERRACE - TERRASSEN GELÄNDER - MAIN COURANTE DE TERRASSE 	1	18x90	3060
GL	GABLE MOULDING - GIEBELLEISTE - PLANCHE DE RIVE 	4	18x120	3350
KL4	LENGTHENING BOLT FOR TREADED ROD - VERLÄNGERUNGSMUTTER FÜR GEWINDESTANGE - MANCHON DE RACCORDEMENT DE TIGE FILETÉE 	5		
KL1	DRIVE NUT TREADED ROD - EINSCHLAGMUTTER FÜR GEWINDESTANGE - ÉCROU A FRAPPER POUR TIGE FILETÉE 	5		
KL2	NUT FOR TREADED ROD - MUTTER FÜR GEWINDESTANGE - ÉCROU POUR TIGE FILETÉE 	5		
KL3	PLAIN WASHER TREADED ROD - UNTERLEGSCHIEBE FÜR GEWINDESTANGE - RONDELLE PLATE POUR TIGE FILETÉE 	5		
	SCREW FOR GABLE SEGMENT - SCHRAUBEN FÜR DECKBLATT - VIS POUR FIXATION LOSANGE DE FINITION 	4	3.5x35	
HS83	SCREW FOR FIXING FILLET - SCHRAUBEN FÜR FIXIRUNGSLEISTE - VIS POUR PROFIL DE FIXATION 	124	3.5x50	
HS84	SCREW FOR FIXING FILLET - SCHRAUBEN FÜR FIXIRUNGSLEISTE - VIS POUR PROFIL DE FIXATION 	68	3.5x50	
HS16	SCREW FOR GABLE MOULDING - SCHRAUBEN FÜR GIEBELLEISTE - VIS DE FIXATION POUR PLANCHE DE RIVE 	40	3.5x50	
HS32	SCREW FOR EAVES BOARDS - SCHRAUBEN FÜR TRAUFBRETTER - VIS DE FIXATION POUR BANDEAU DE TOIT 	28	4x40	
HS26	SCREW FOR ROOF EDGE REINFORCEMENT - SCHRAUBEN FÜR DACHRANDVERSTÄRKUNG - VIS POUR RENFORT DE BORD DE TOIT 	28	4x40	
HS30	SCREW FOR TERRACE REAR BOARDS - SCHRAUBEN FÜR TERRASSEN RAND - VIS DE FIXATION POUR MAIN COURANTE DE TERRASSE 	80	4x40	
HS34	SCREW FOR POST - SCHRAUBEN FÜR PFOSTEN - VIS DE FIXATION DES POTEAUX 	2	4x60	
HS36	SCREW FOR STEPLADDER - SCHRAUBE FÜR LEITER - VIS D'ASSEMBLAGE DES MARCHES DE L'ECHELLE 	36	4x60	
HS40	SCREW FOR 1. WALL BEAM - SCHRAUBE FÜR 1. BOHLENREIHE - VIS DE FIXATION DES FONDATIONS 	17	5x120	
HS43	SCREW FOR ROOF BEAMS - SCHRAUBEN FÜR DACHBALKEN - VIS POUR PANNE DE TOIT 	20	5x120	
	SCREW FOR GABLE - SCHRAUBEN FÜR GIEBEL - VIS POUR FIXATION DES PIGNONS 	28	5x120	
HS39	SCREW FOR FUNDAMENT - SCHRAUBEN ZUR BEFESTIGUNG FUNDAMENT - VIS POUR FONDATION 	44	5x90	
	SCREW FOR MEZZANINE FLOOR JOISTS - SCHRAUBEN FÜR HALBGESCHOSS BALKEN - VIS DE FIXATION SOLIVES DE PLANCHER MEZZANINE 	60	5x90	
HS65	SCREWS FOR FIXING THE TERRACE PANELS - SCHRAUBEN FÜR TERRASSEN ELEMENT - VIS DE FIXATION DES ÉLÉMENTS DE TERRASSE 	40	5x90	
HS49	SCREW FOR POST HEIGHT ADJUSTMENT - SCHRAUBEN FÜR RÉGULIERUNGSSCHRAUBE FÜR PFOSTEN - VIS DE FIXATION DE SUPPORT RÉGLABLE DE POTEAU 	8	6x50	
	ZN NAIL FOR FLOOR FILLET - ZN NÄGEL FÜR FUSSBODENLEISTE - POINTE POUR CORNIERE DE FINITION DU PLANCHER 	93	1.4x40	

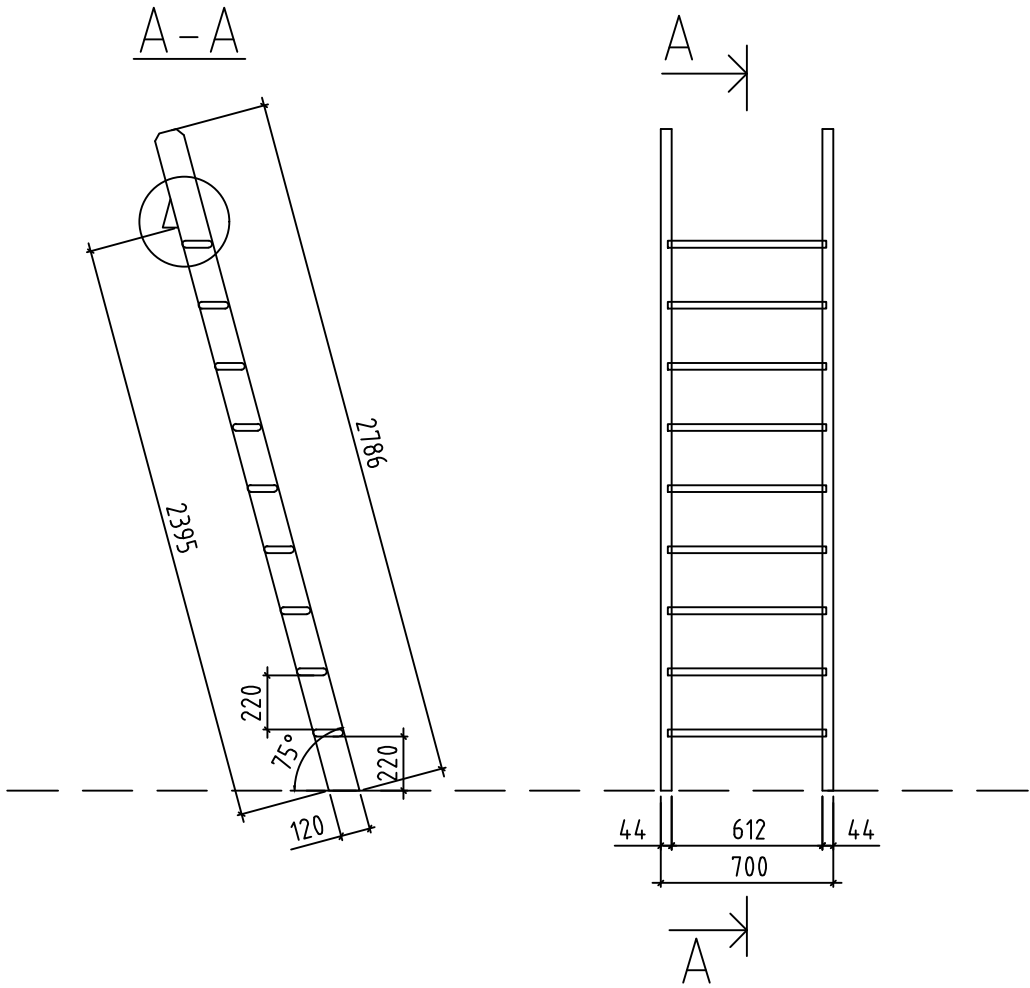
Pos	TIGRIS, Art.No.701802 Piece list - Stückliste - Liste des pieces	Q.	P (mm)	L (mm)
SH70	HAMMER BLOCK - SCHLAGHOLZ - CALLE DE FRAPPE 	1		
	SCREW FOR DOORSTEP - SCHRAUBEN FÜR TÜRSCHWELLE - VIS DE FIXATION DU SEUIL DE PORTE 	4	4.5x65	
NFD	ZN NAIL FOR ROOFING FELT FILLET - ZN NÄGEL FÜR DACHPAPPENLEISTE - POINTE POUR BAGUETTE FIXATION FEUTRE BITUMEUX 	32	2x40	
NF3	SCREW FOR TERRACE - SCHRAUBEN FÜR TERRASSENBRETTEN - VIS DE FIXATION POUR PLANCHER DE TERRASSE 	224	4.2x50	
NF2	ZN NAIL FOR ROOF - SCHRAUBEN FÜR DACHBRETTEN - POINTE POUR TOIT 	700	2x50	
NH1	SCREW FOR FLOOR - ZN NÄGEL FÜR FUSSBODENBRETTEN - VIS DE FIXATION POUR PLANCHER 	910	3.5x50	
GS	GABLE SEGMENT-DECKBLATT - LOSANGE DE FINITION 	2		
SP1	HIDDEN FIXING - HOLZDÜBEL - TOURILLON BOIS 	3		
RFP	POST HEIGHT ADJUSTMENT - REGULIERUNGSSCHRAUBE FÜR PFOSTEN - SUPPORT RÉGLABLE DE POTEAU 	1		
ORZ	MONTAGE SET FOR DOORS AND WINDOWS - MONTAGE-SET FÜR TÜREN UND FENSTER - JEU DE MONTAGE PORTES ET FENETRES	1		
LR	LADDER - LEITER - ECHELLE 	1		
				

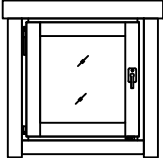
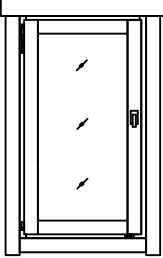
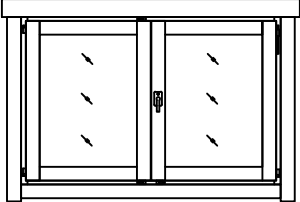
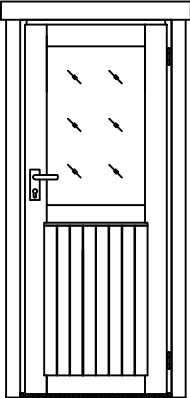
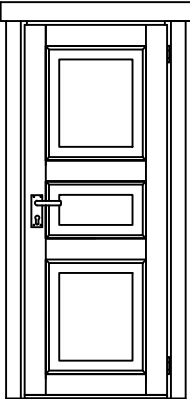
Pos	TIGRIS, Art.No.701802 Piece list - Stückliste - Liste des pieces	Q.	P (mm)	L (mm)
2+ A.0V.c	WINDOW-FENSTER-FENETRE 650x650 	2		
2+ A.0V.d	WINDOW-FENSTER-FENETRE 702x1190 	2		
2+ TA.0P	WINDOW-FENSTER-FENETRE 1374x916 	2		
2+ U.20P	DOOR-TÜR-PORTE 827x1933 	1		
U.3TP	DOOR-TÜR-PORTE 827x1933 	1		

