

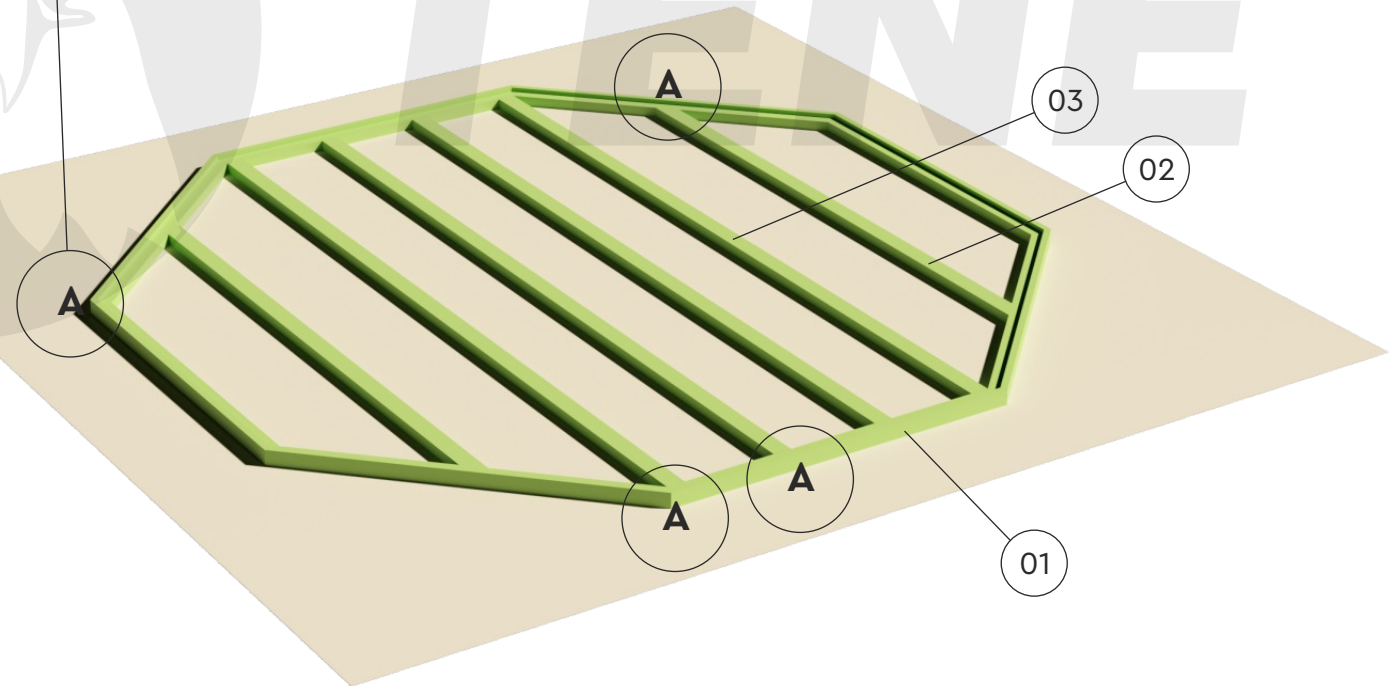

EMMA 4F 40

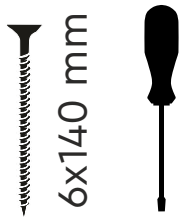

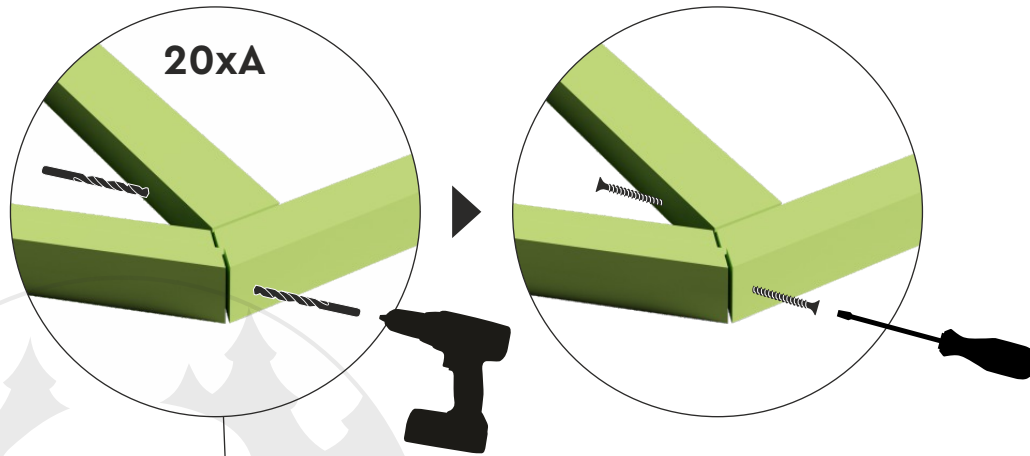
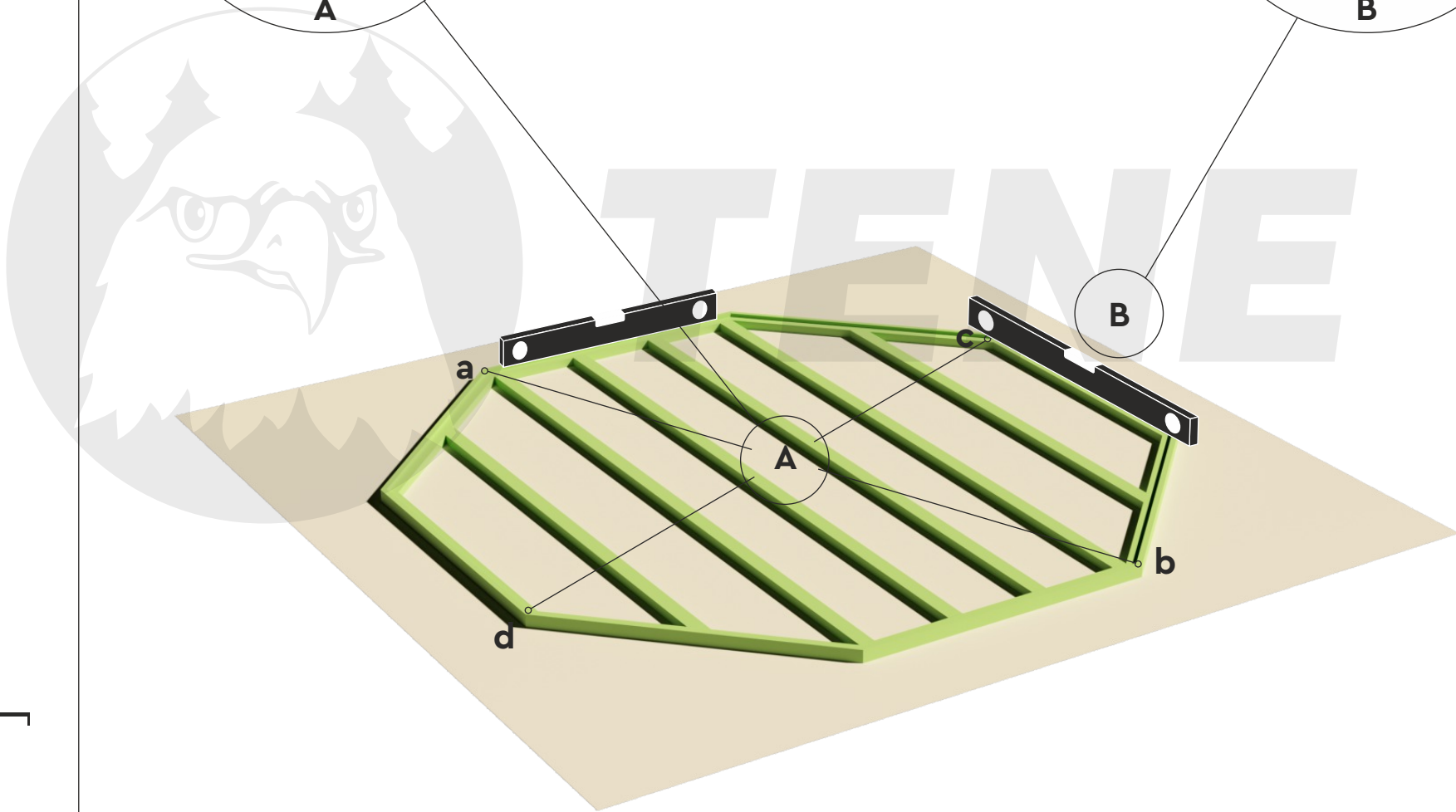
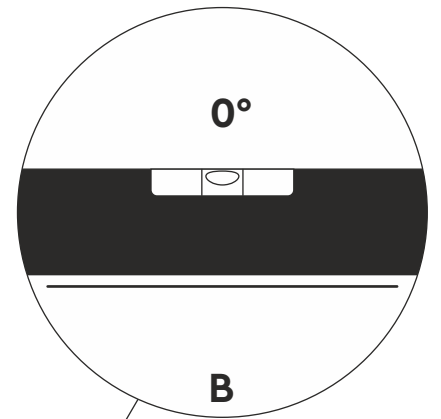
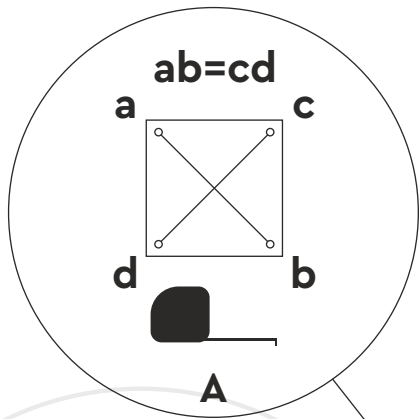

EMMA 4F 40

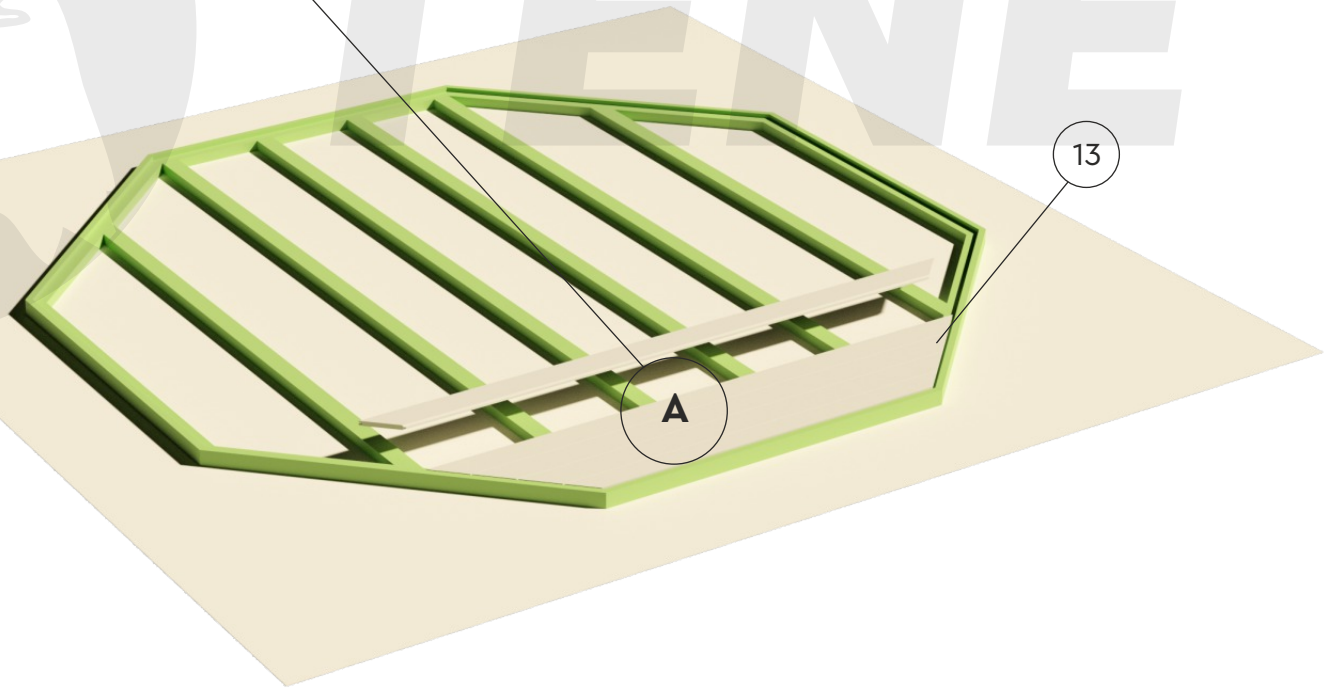
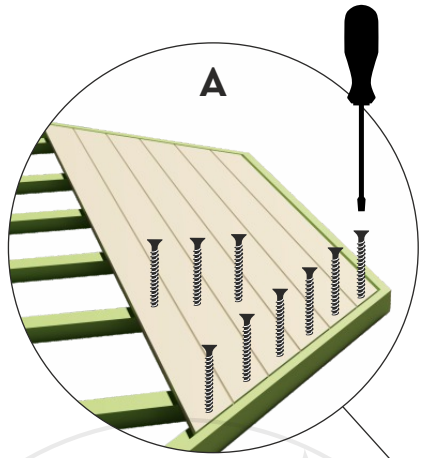

4x50 mm



EMMA 4F 40

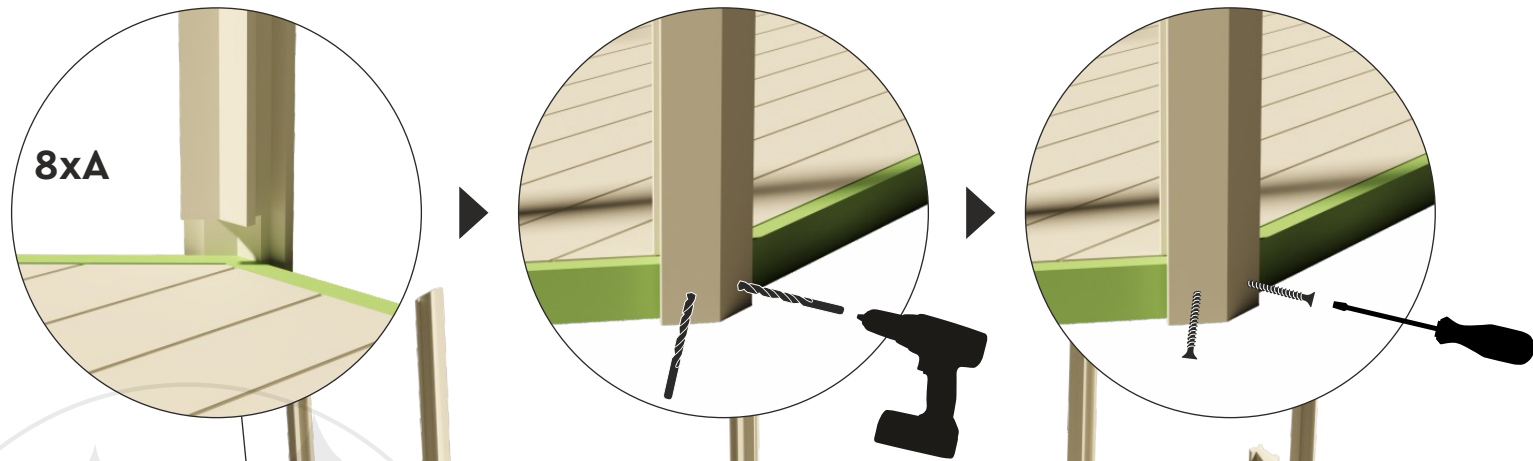

∅ 4 mm

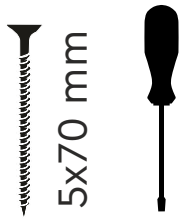

5x70 mm

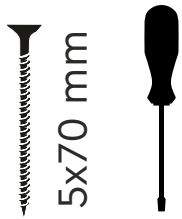
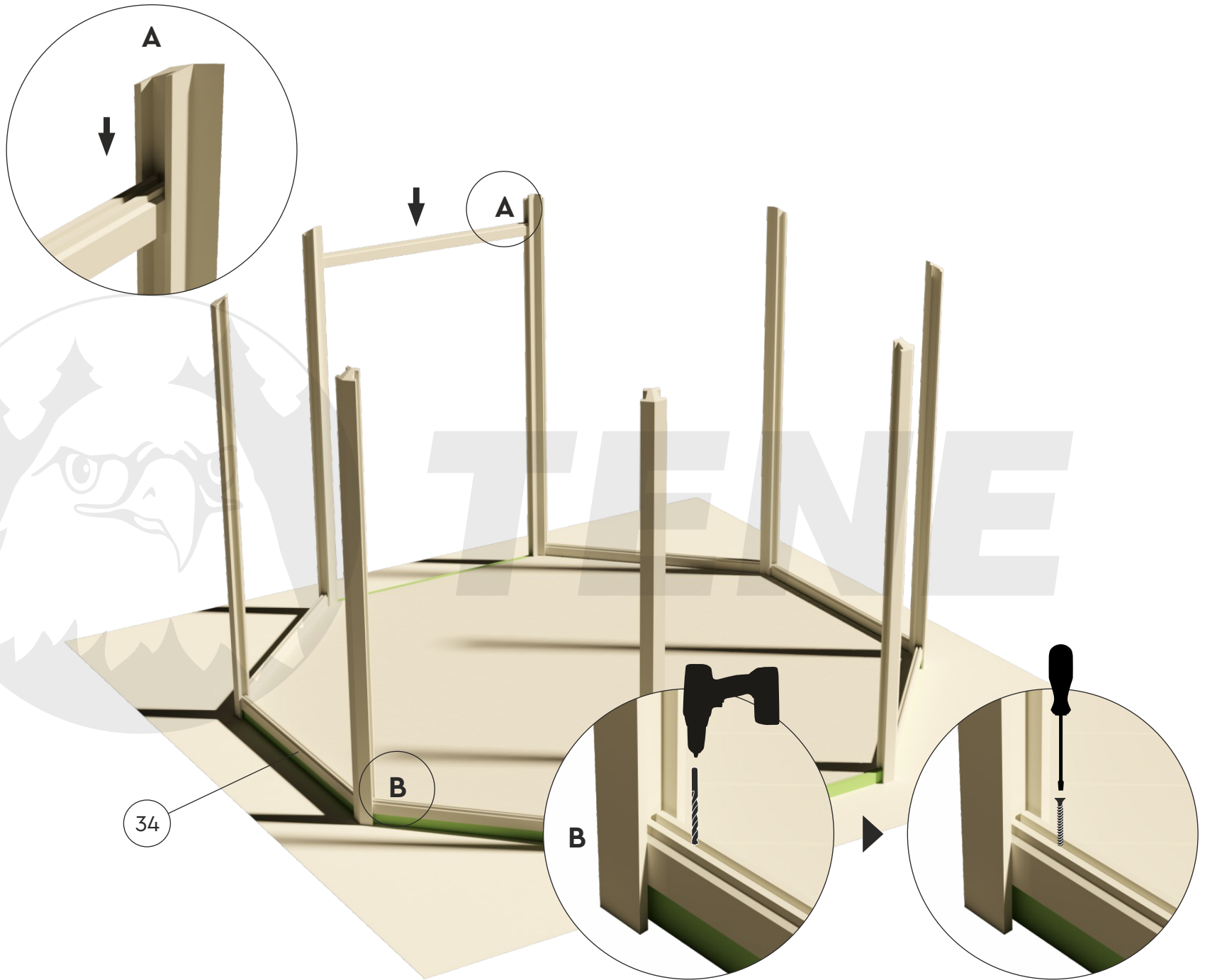

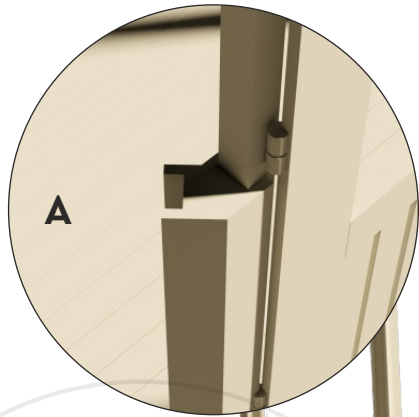

04

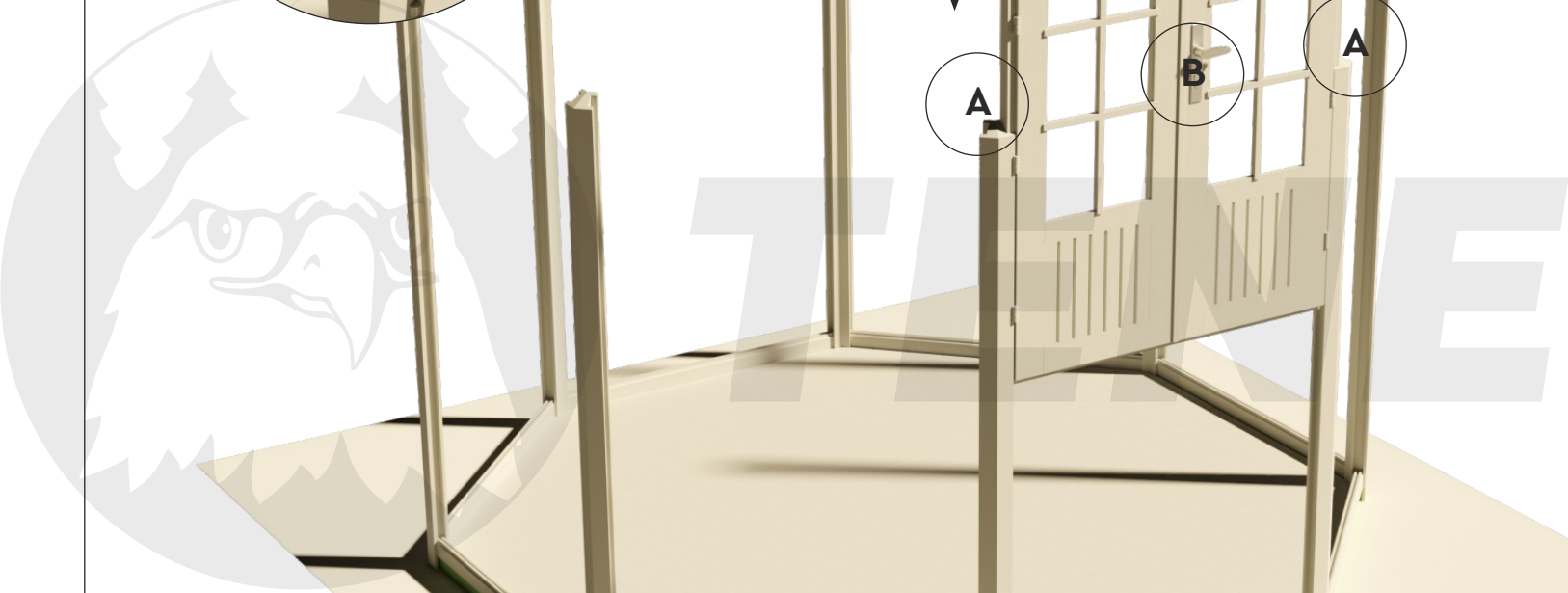
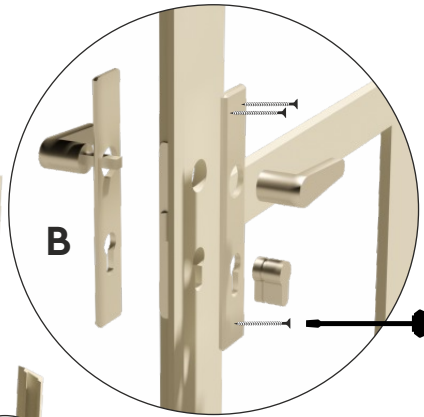

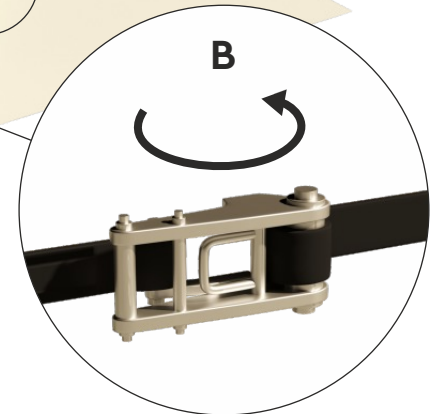
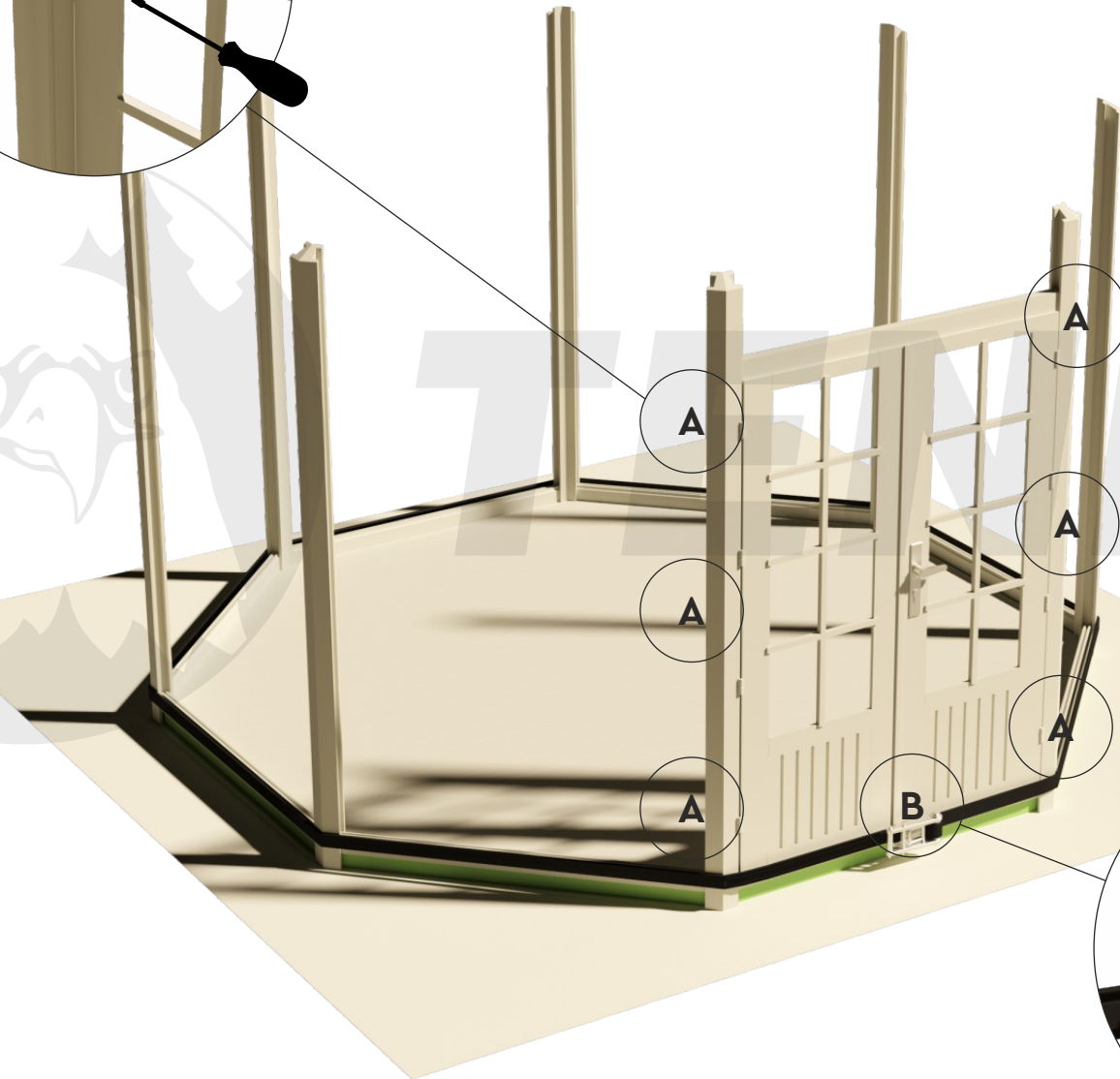
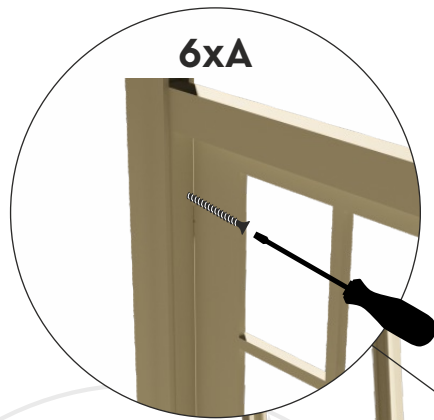
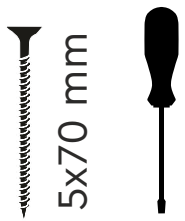
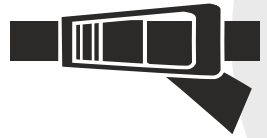

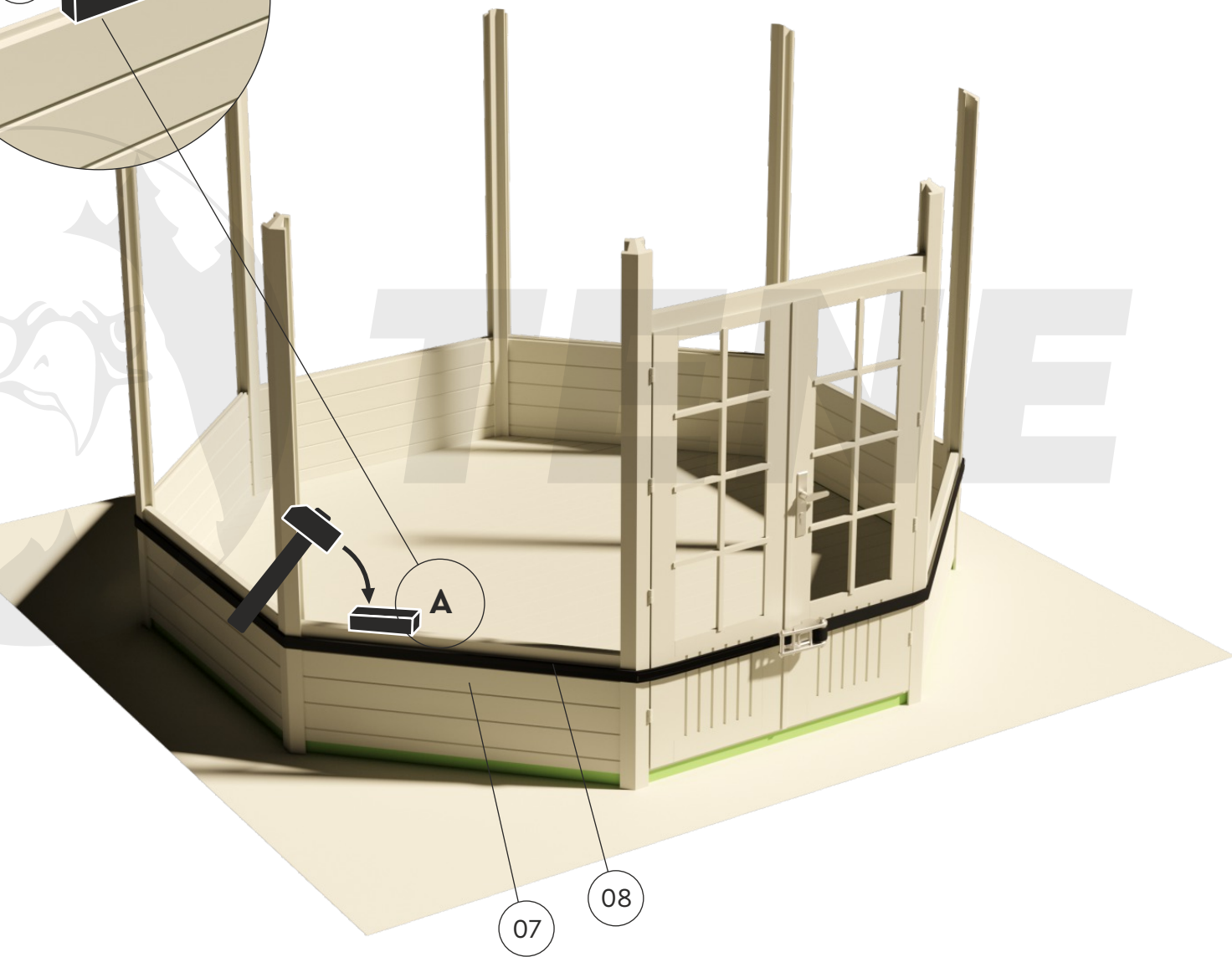
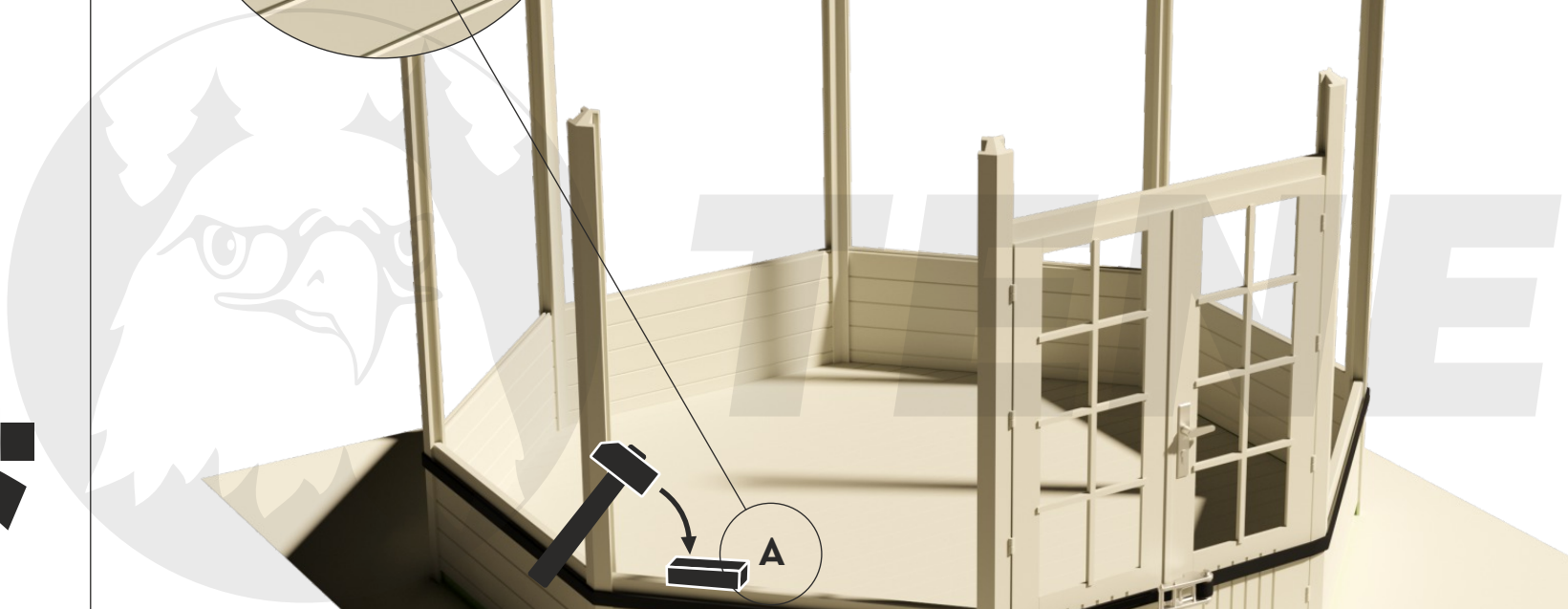
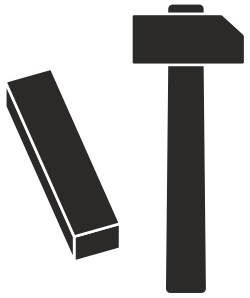
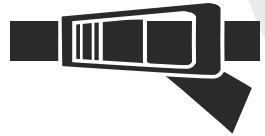
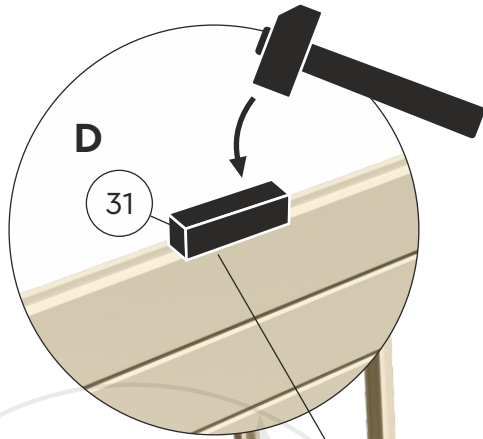

07

08

EMMA 4F 40

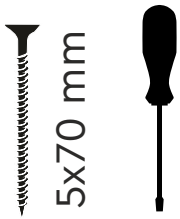
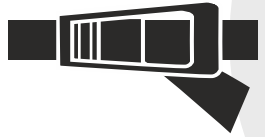
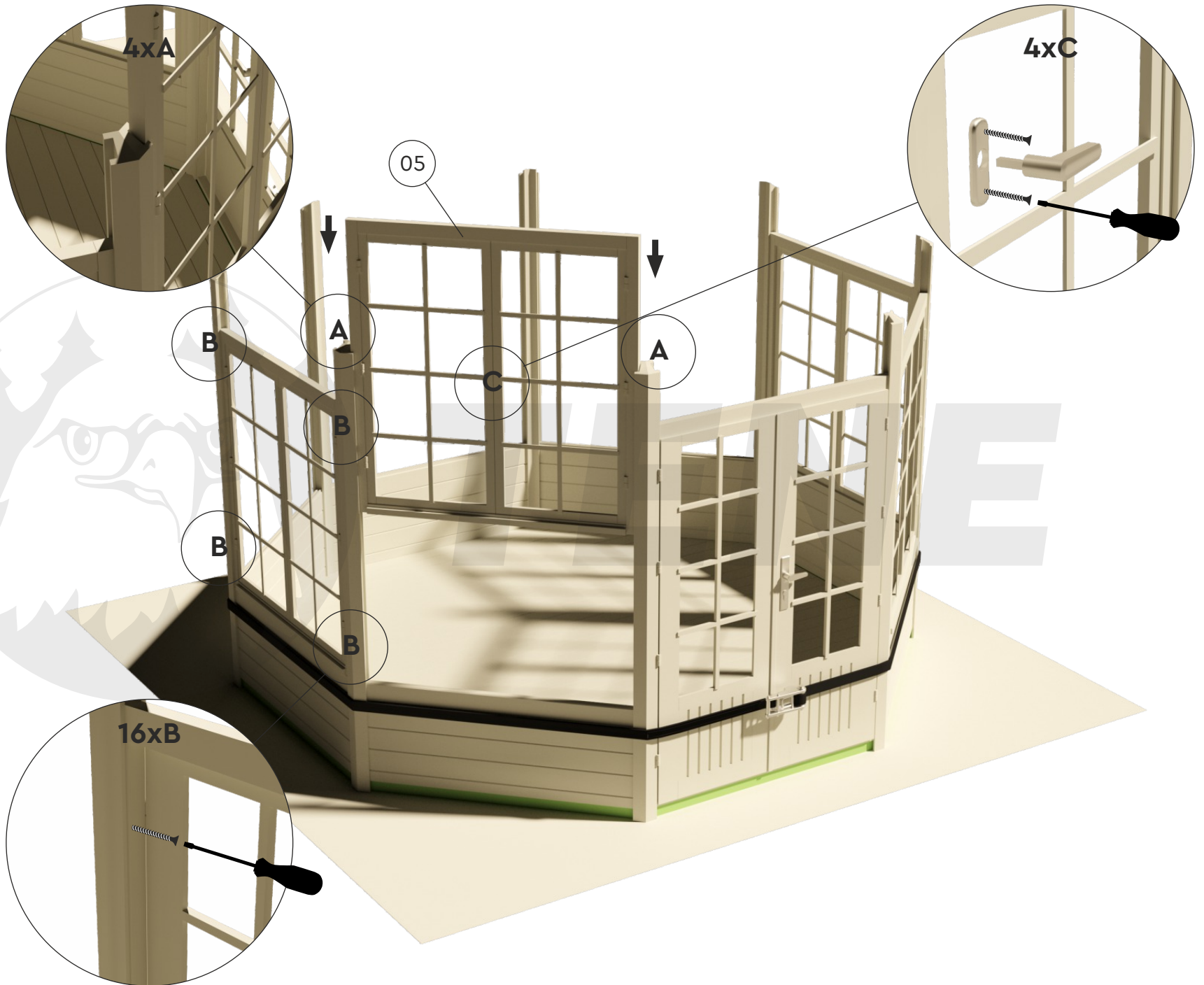

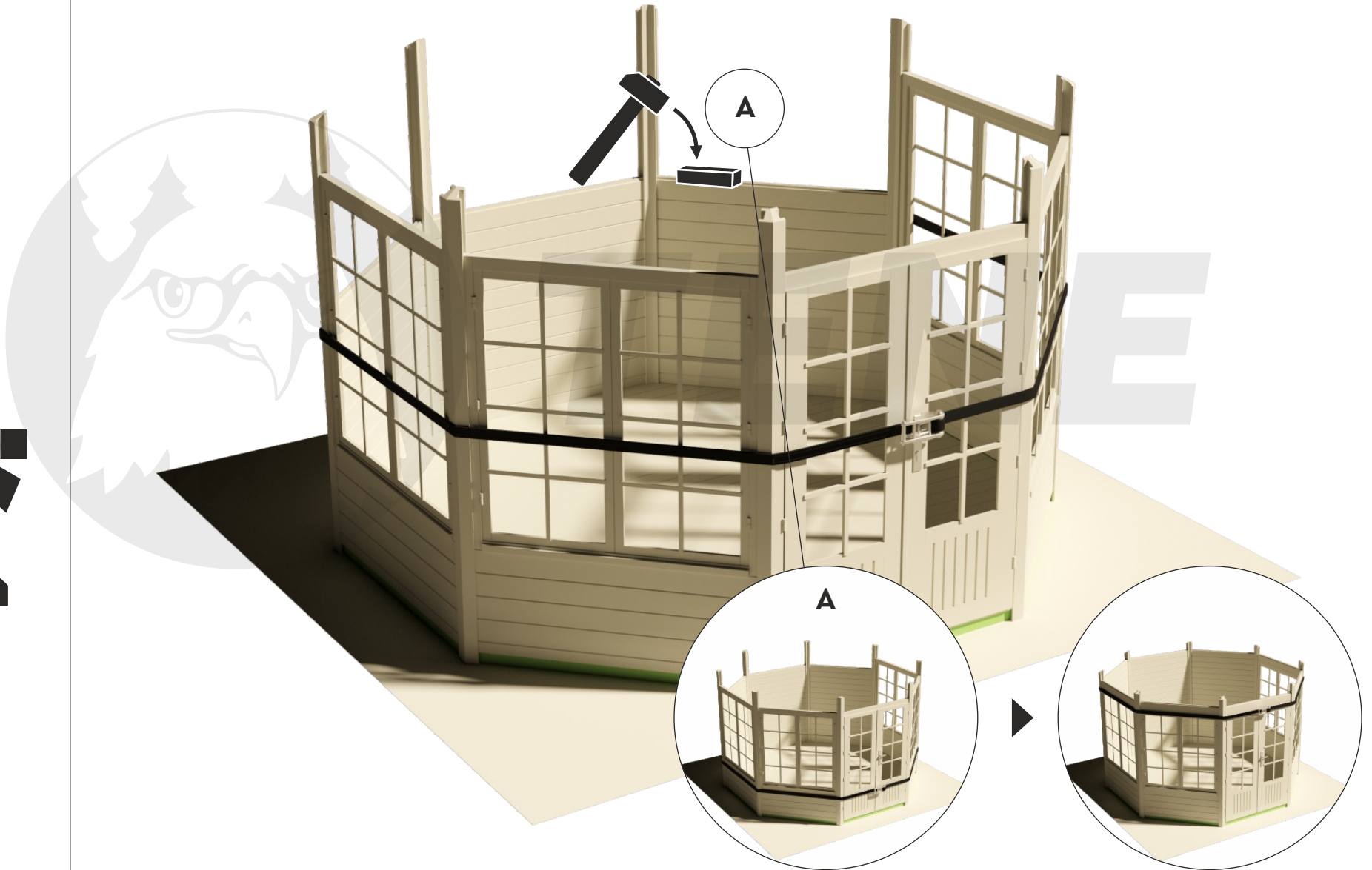
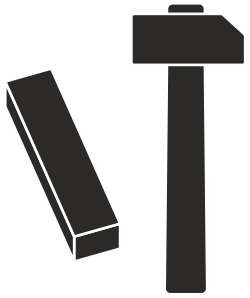
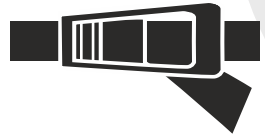

EMMA 4F 40

09

A

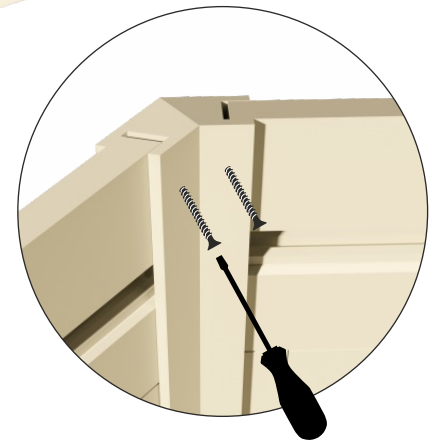
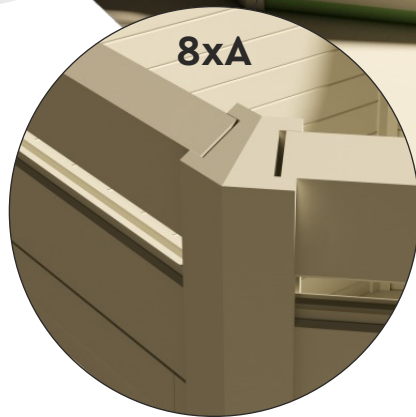
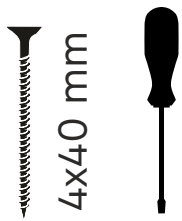
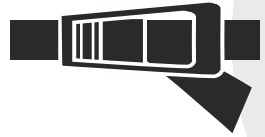

EMMA 4F 40

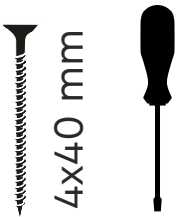
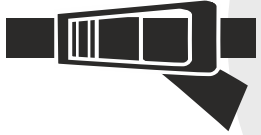
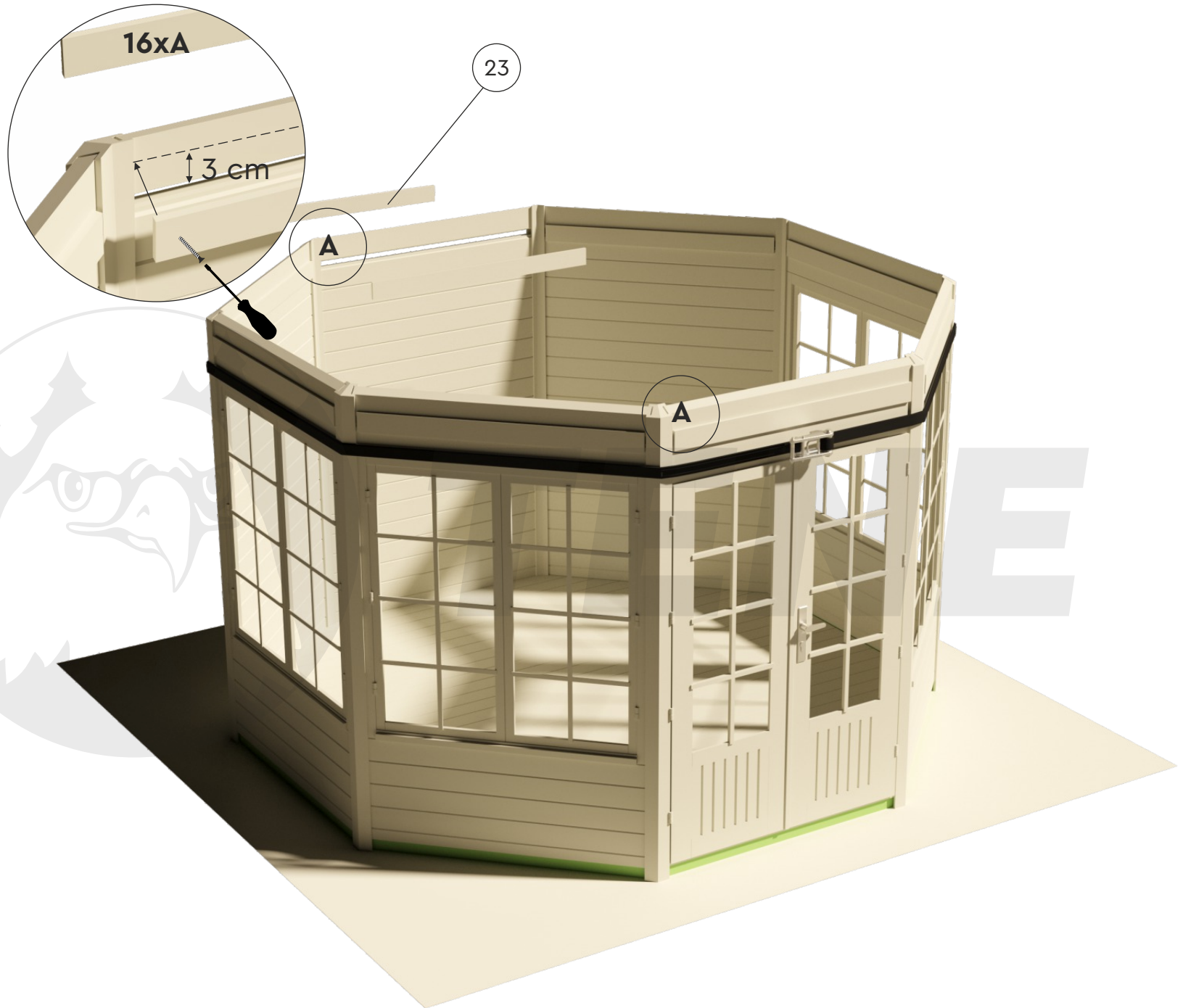

EMMA 4F 40

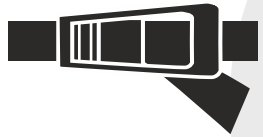

4x50 mm

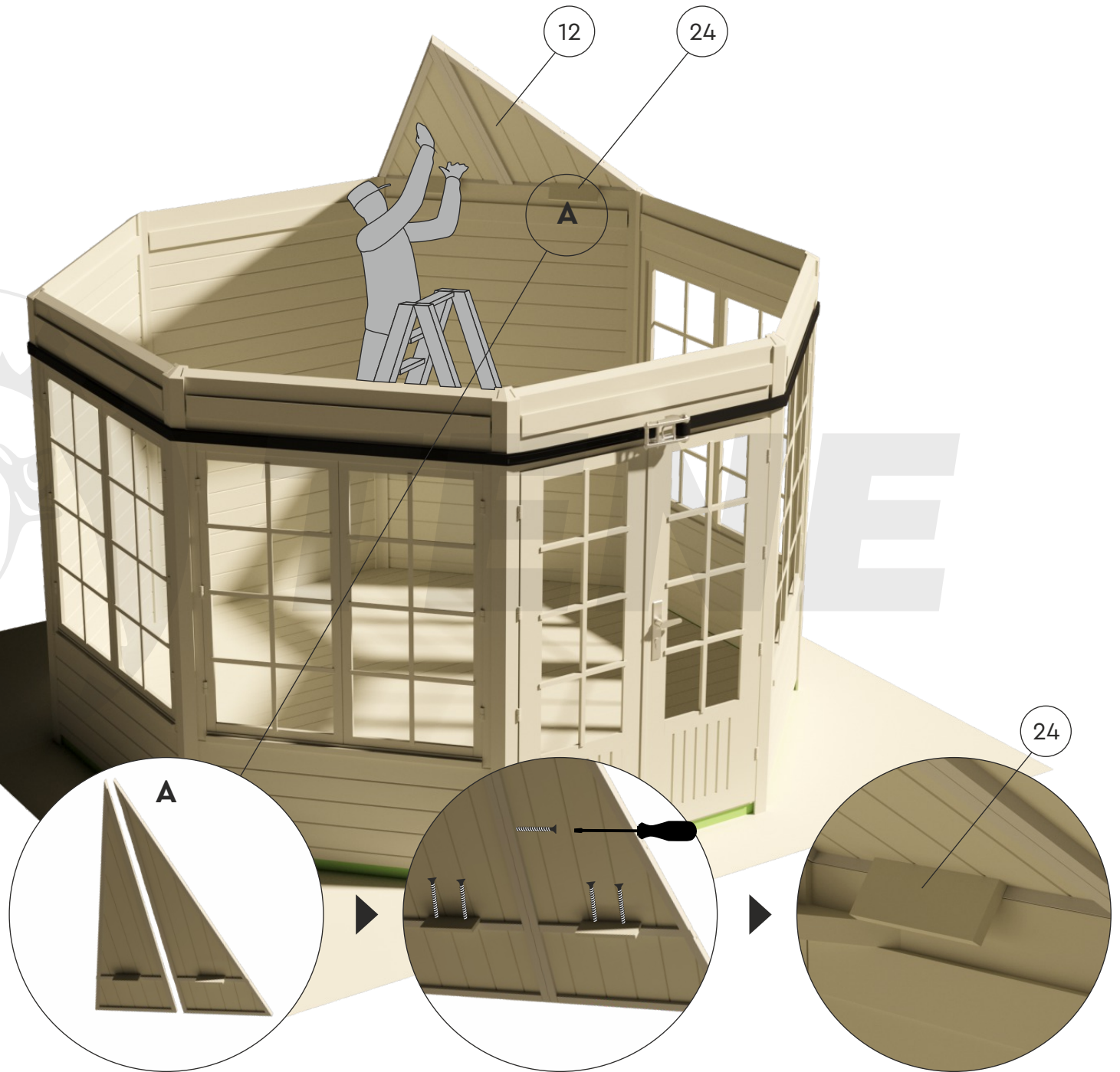
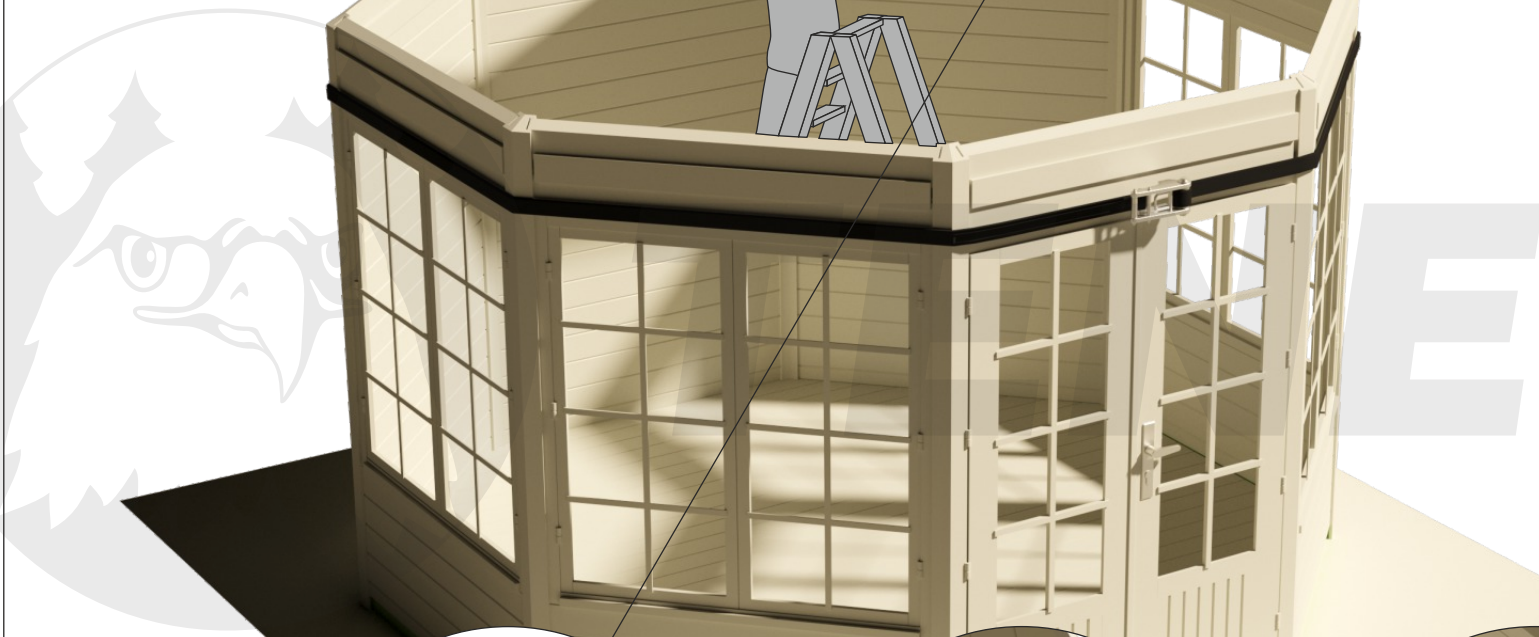

EMMA 4F 40

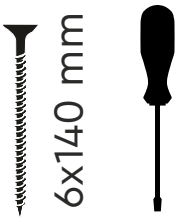
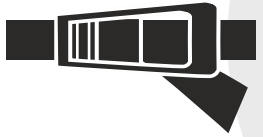
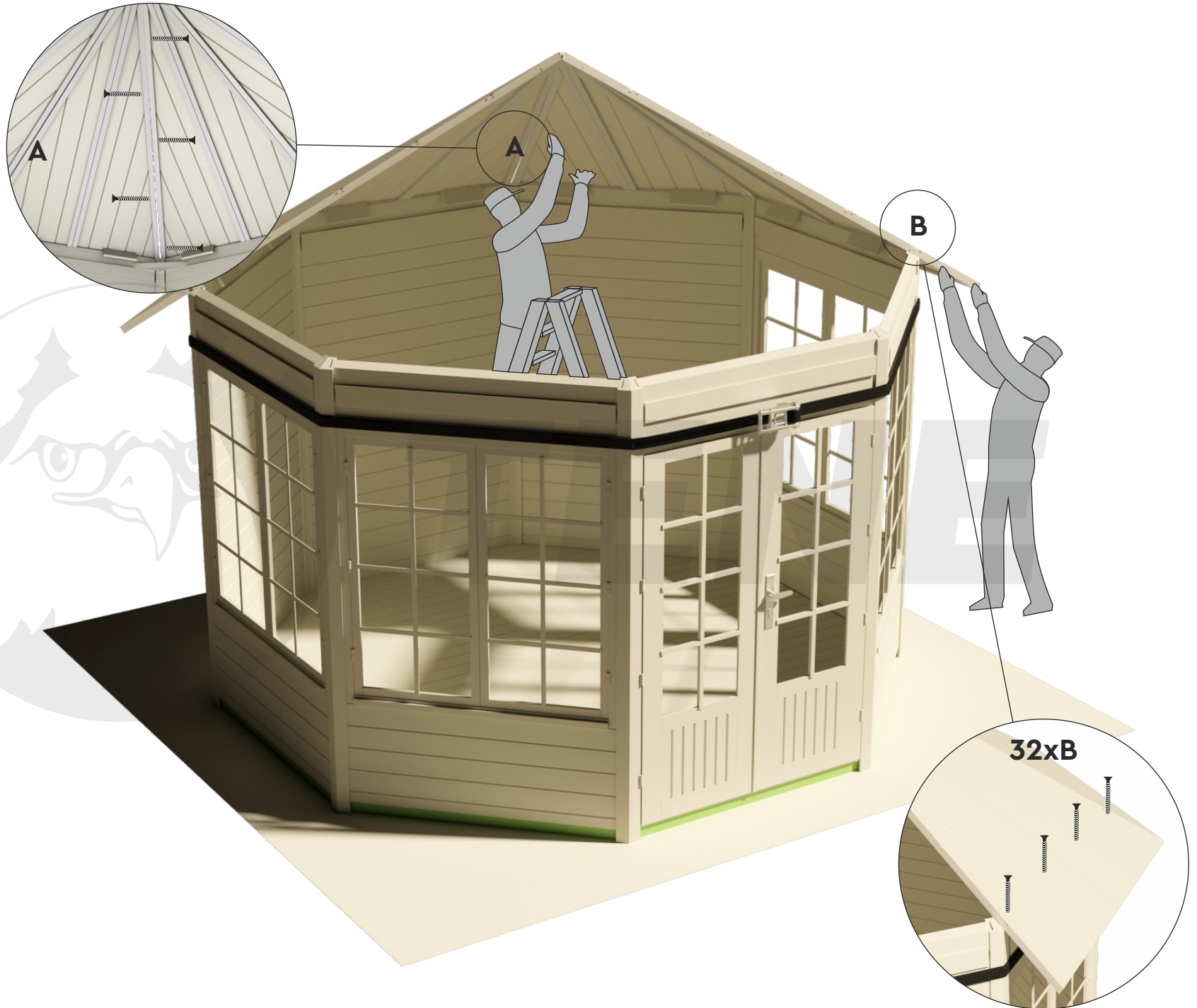

EMMA 4F 40

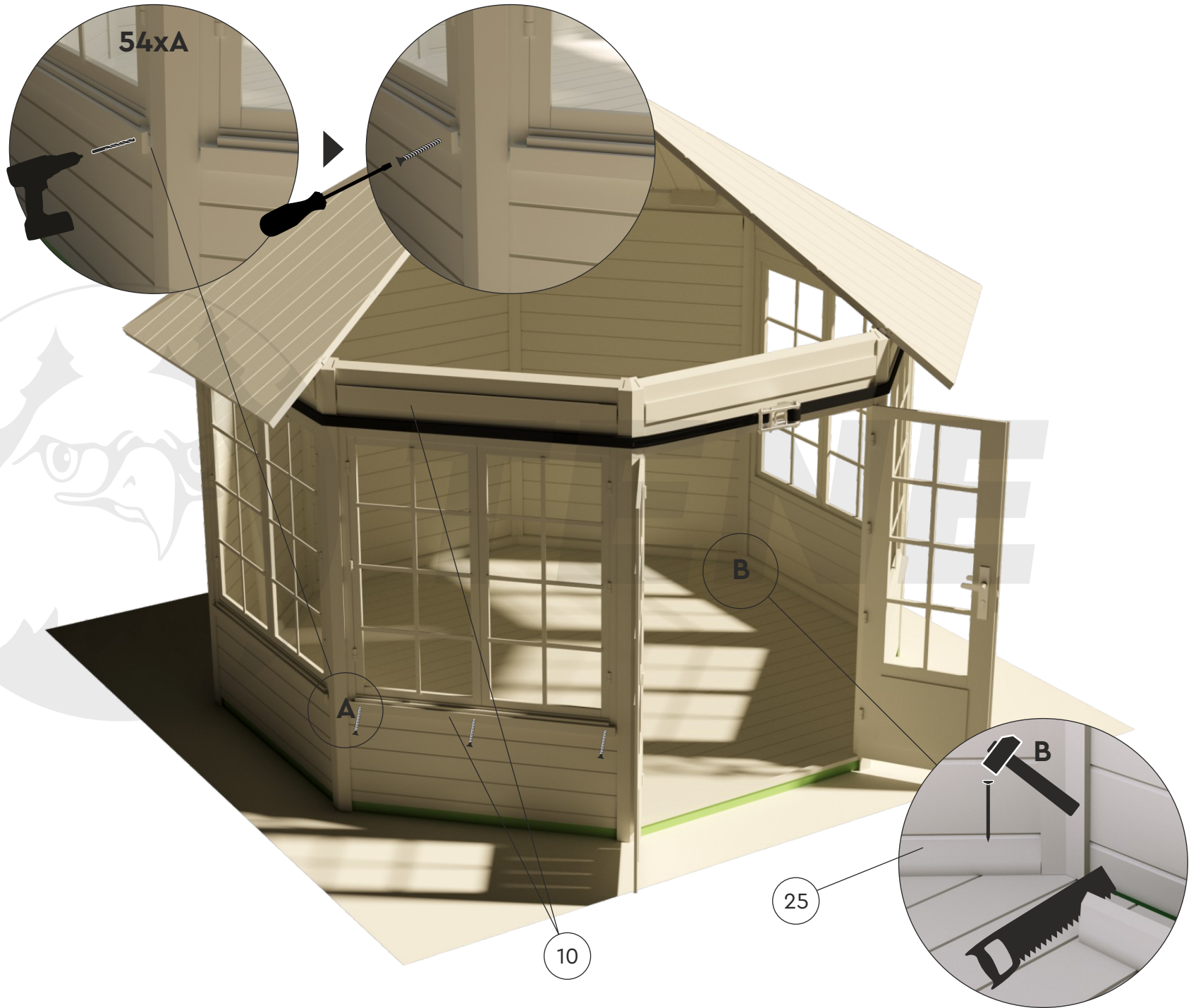
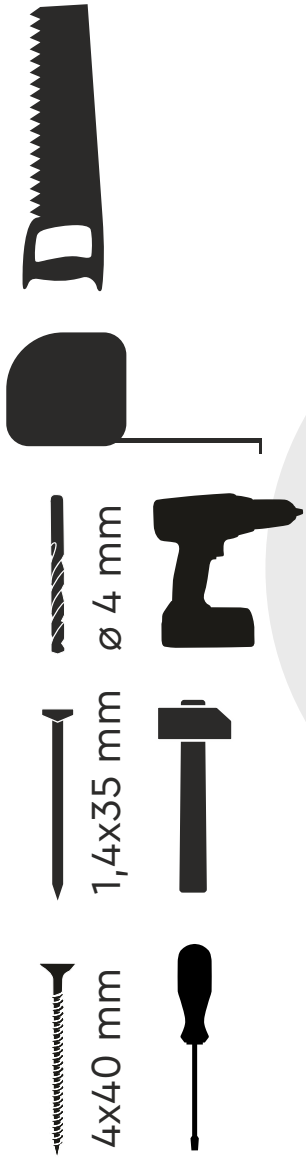

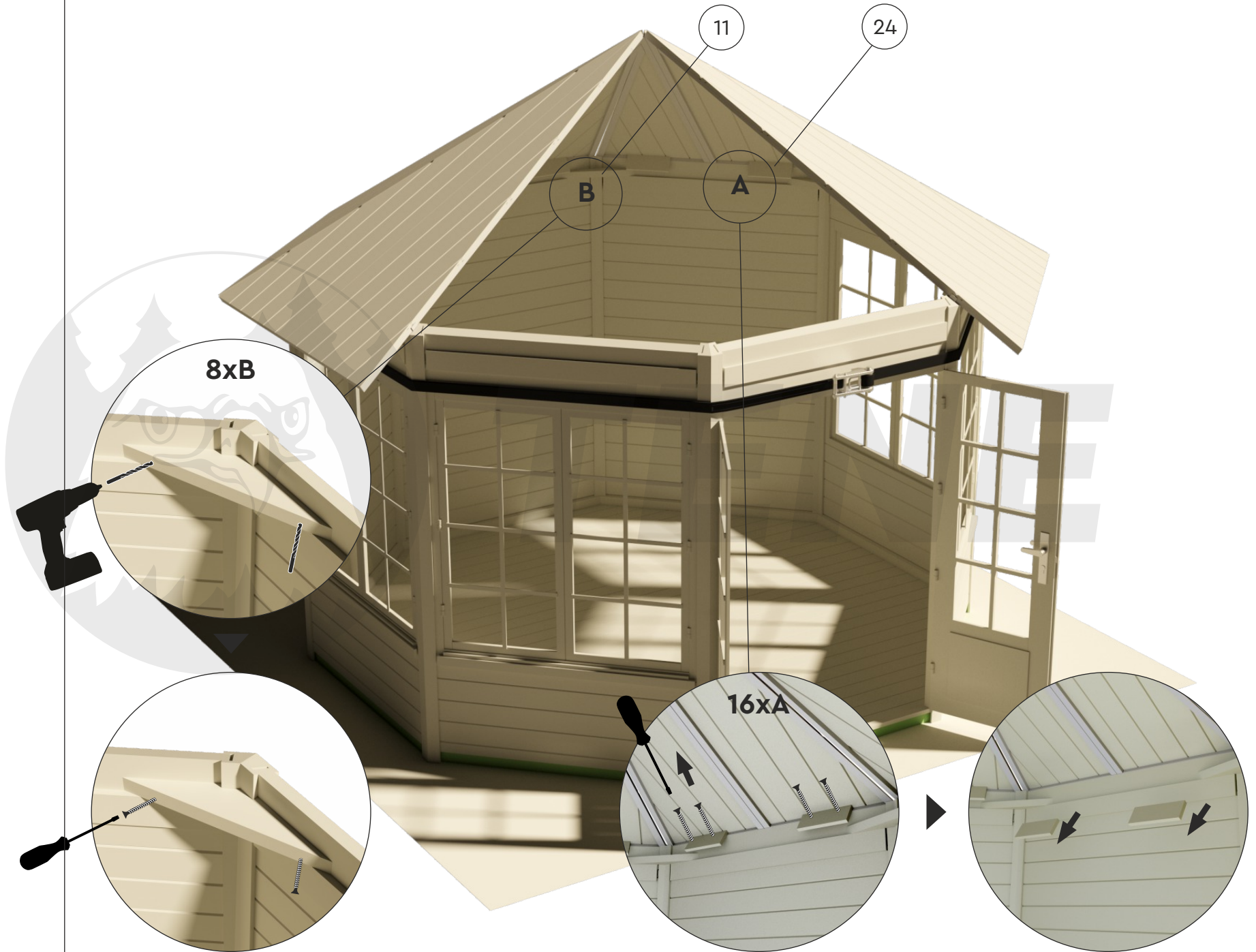

EMMA 4F 40

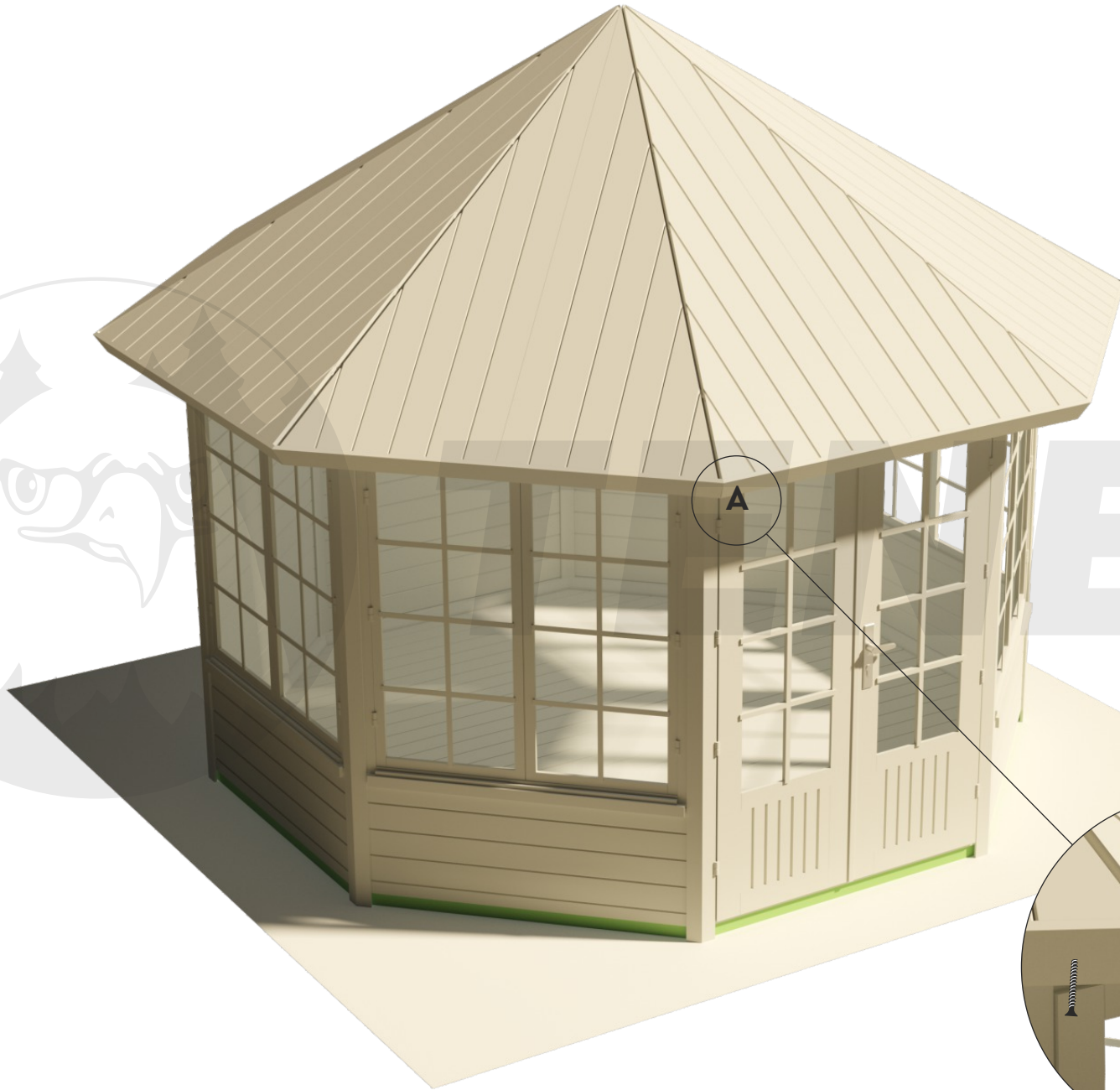

4x40 mm

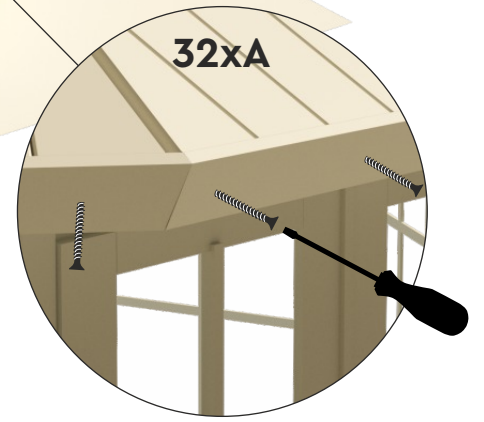

32xA

EMMA 4F 40

