

5 mm

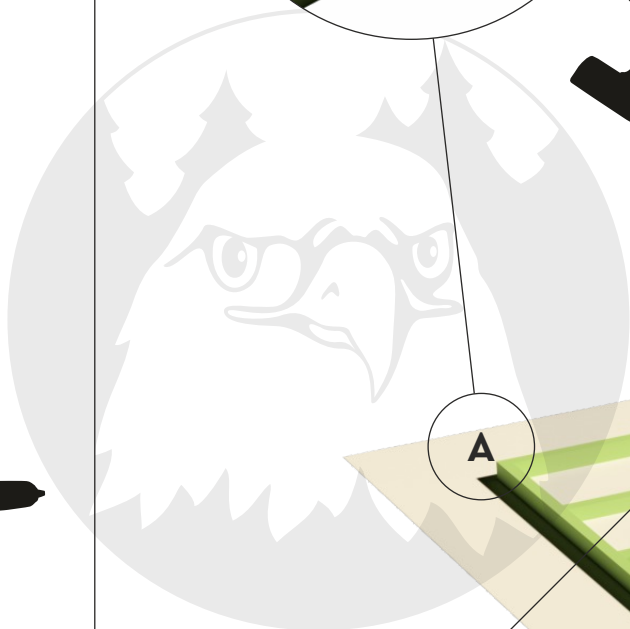

6x140 mm



TENE

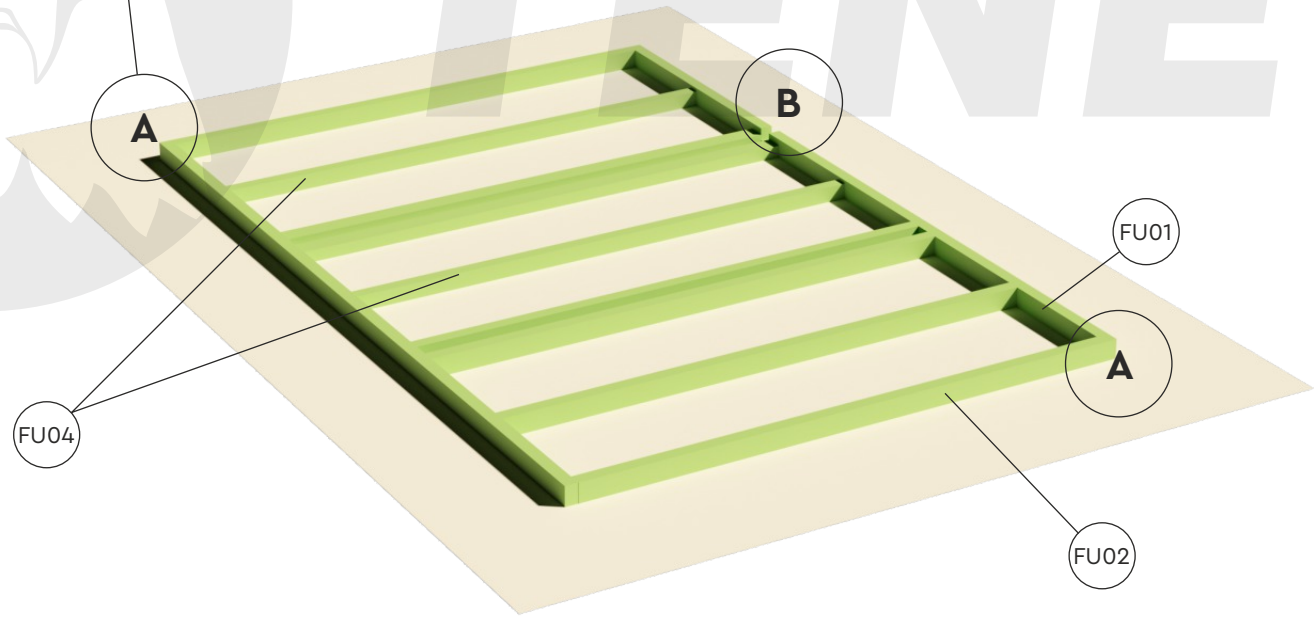

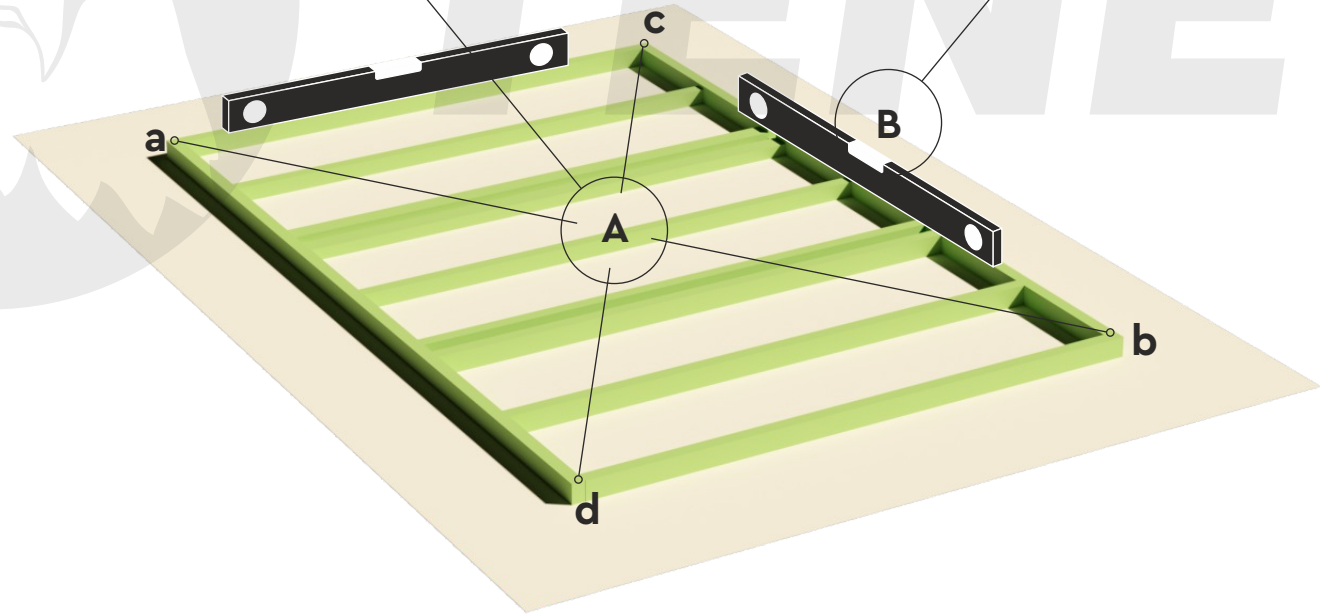
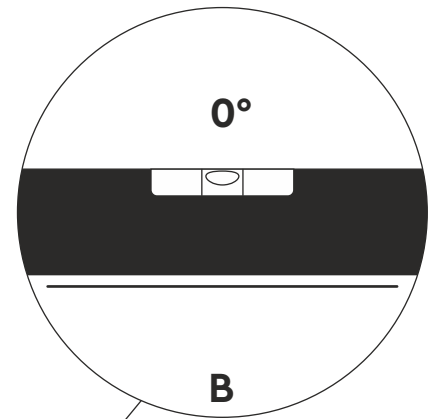
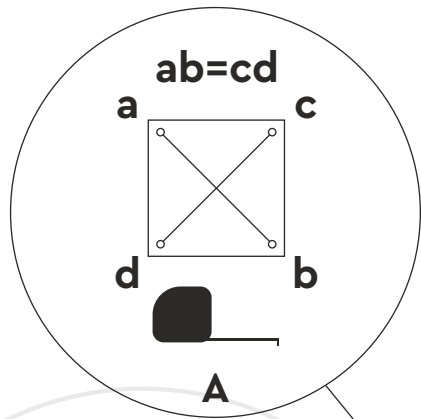



Ø 3 mm

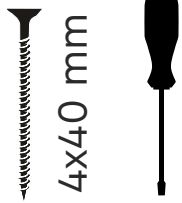

4x40 mm

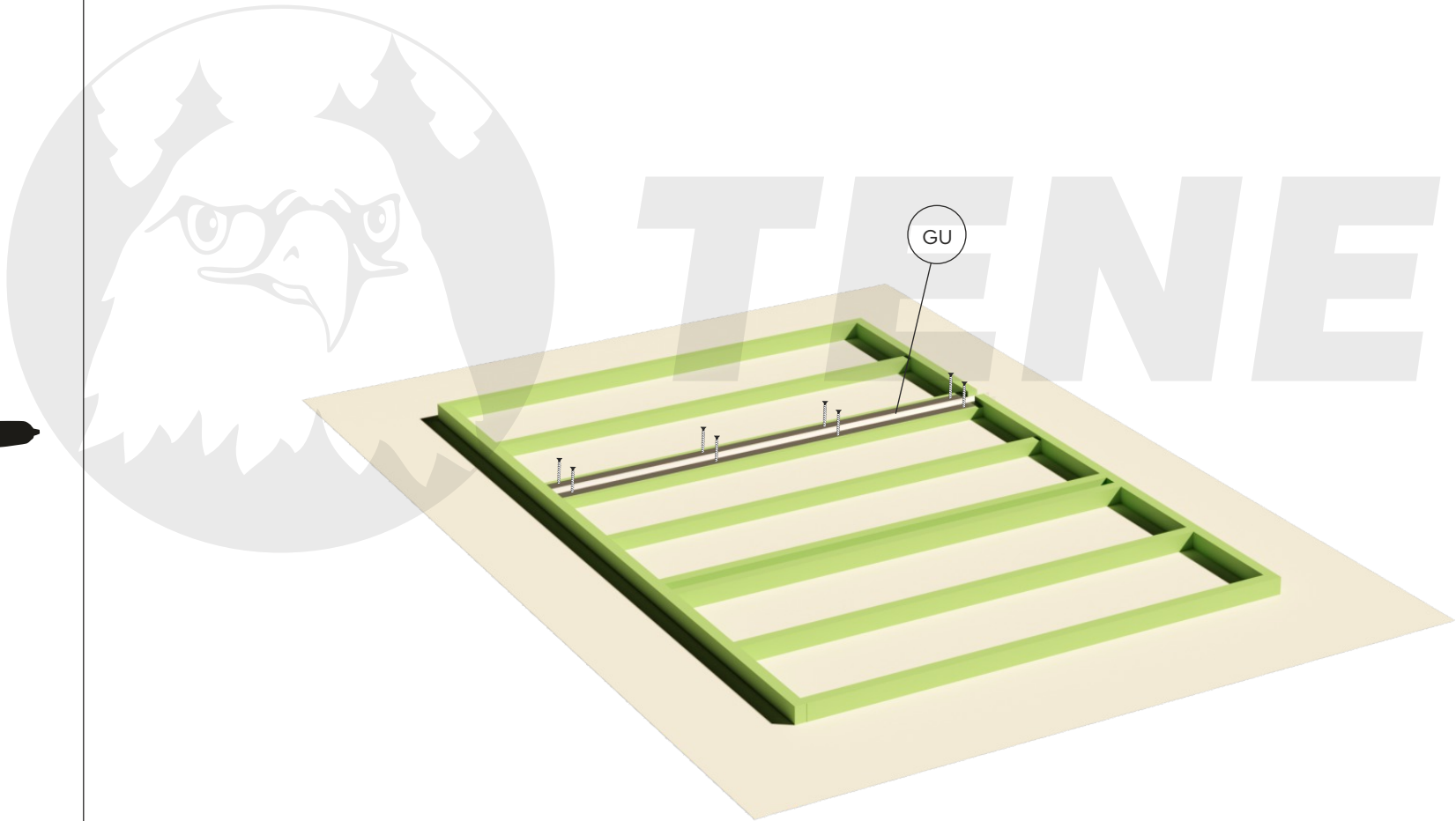



NIKLAS 40

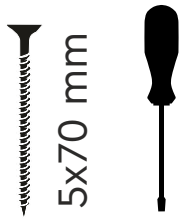
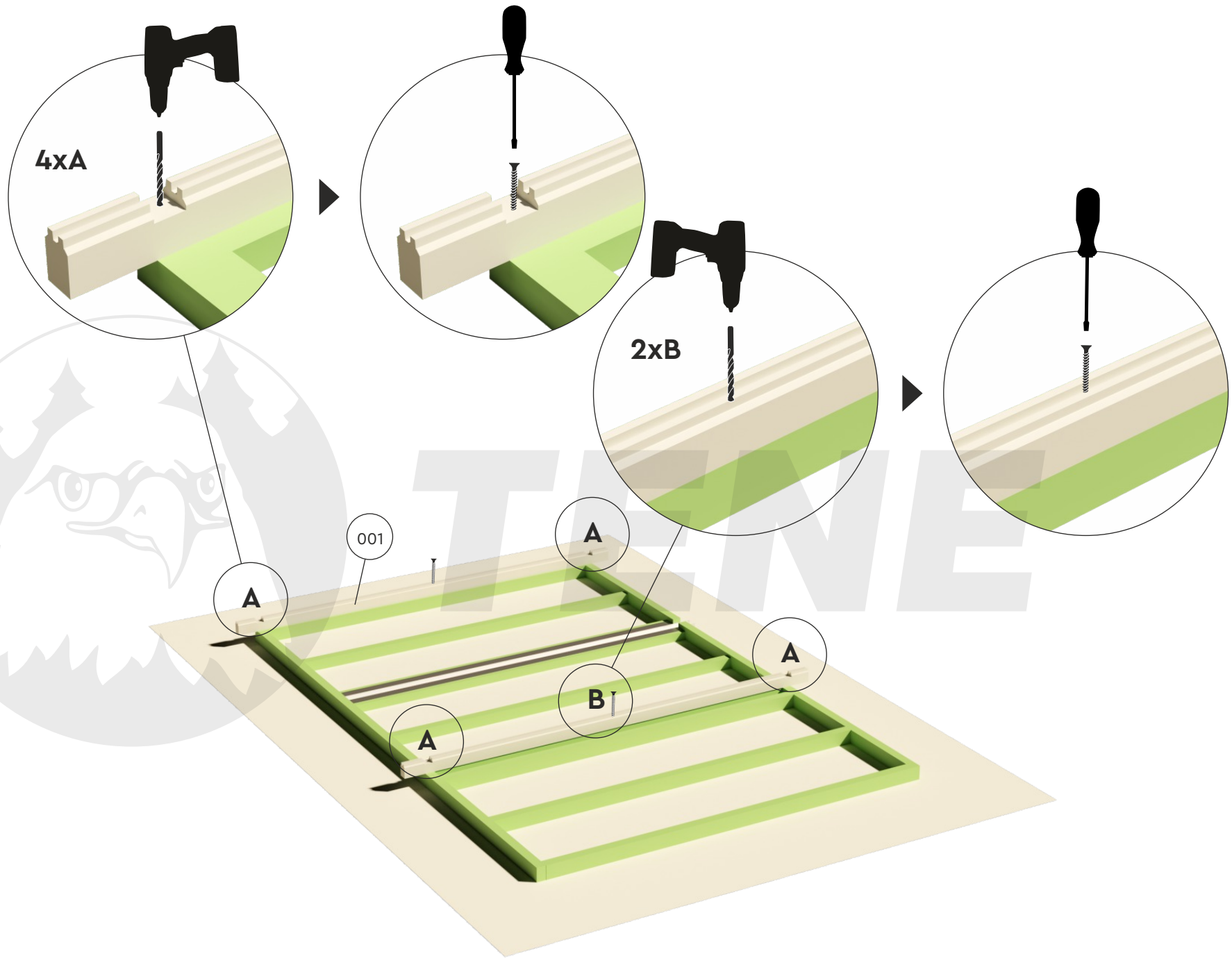

# NIKLAS 40

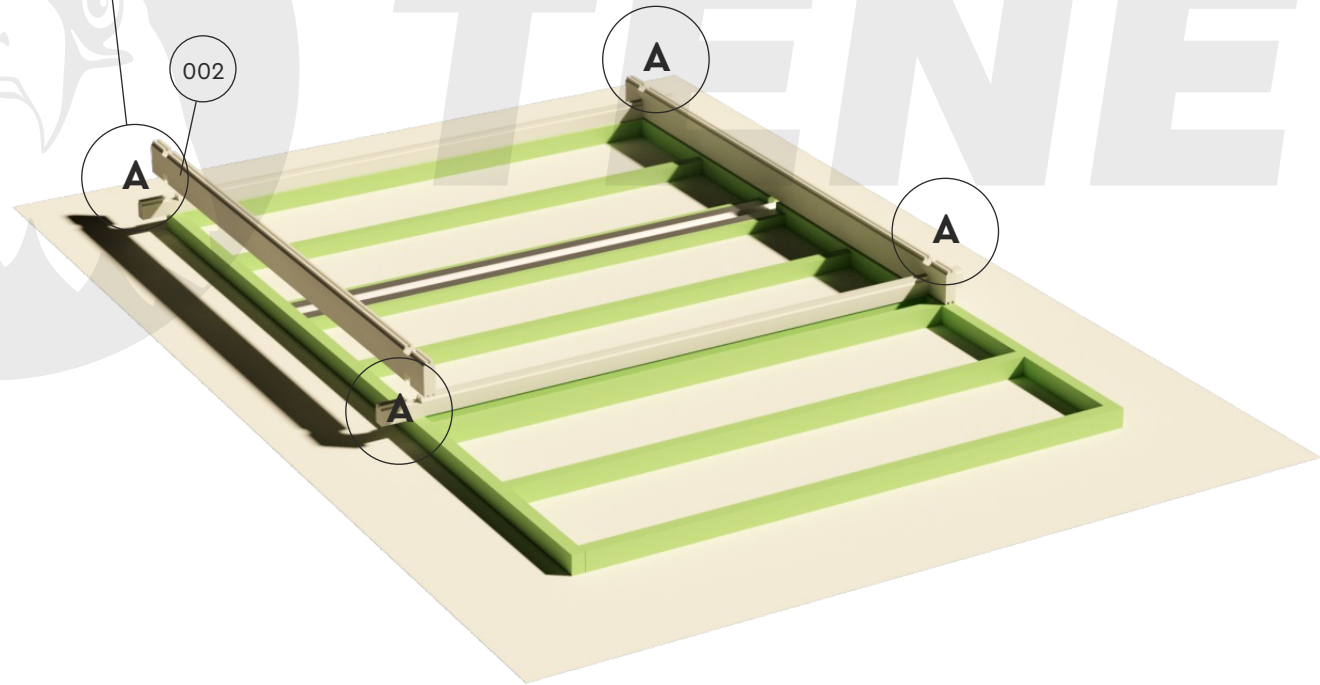
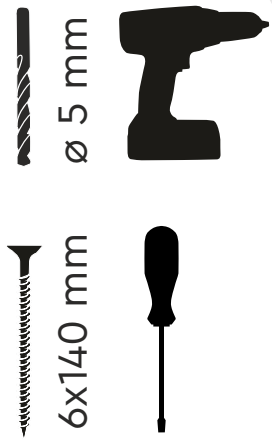
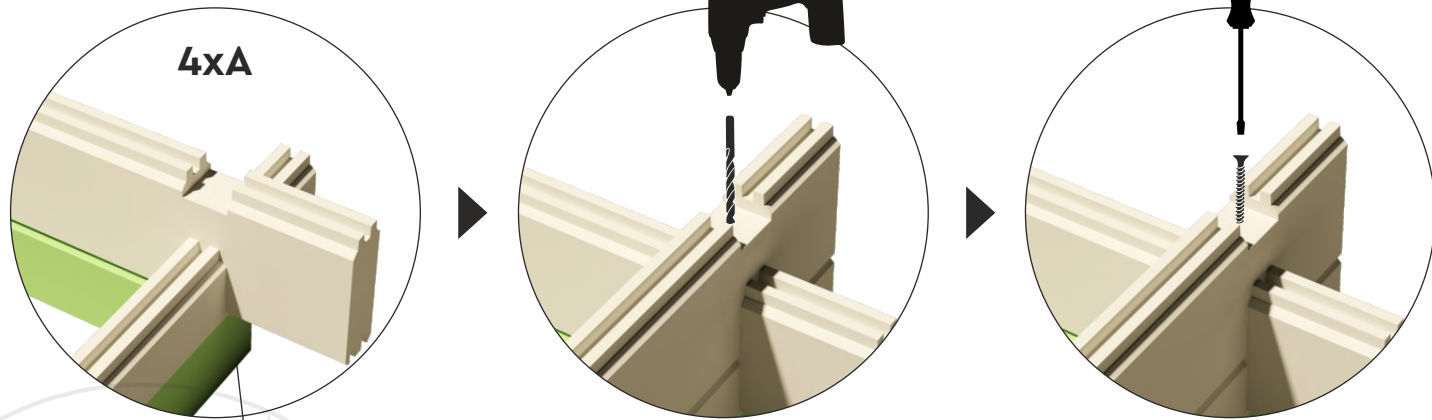

# NIKLAS 40

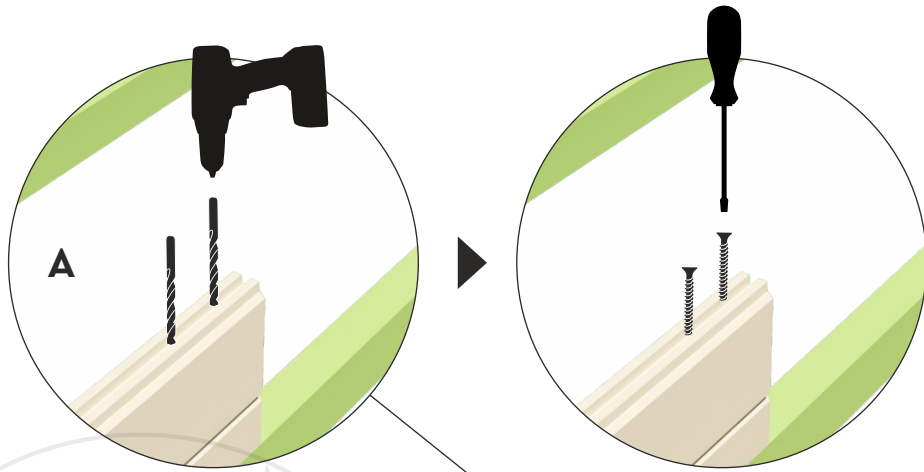

Ø 5 mm

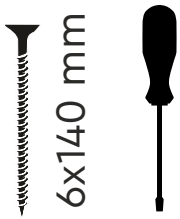

6x140 mm

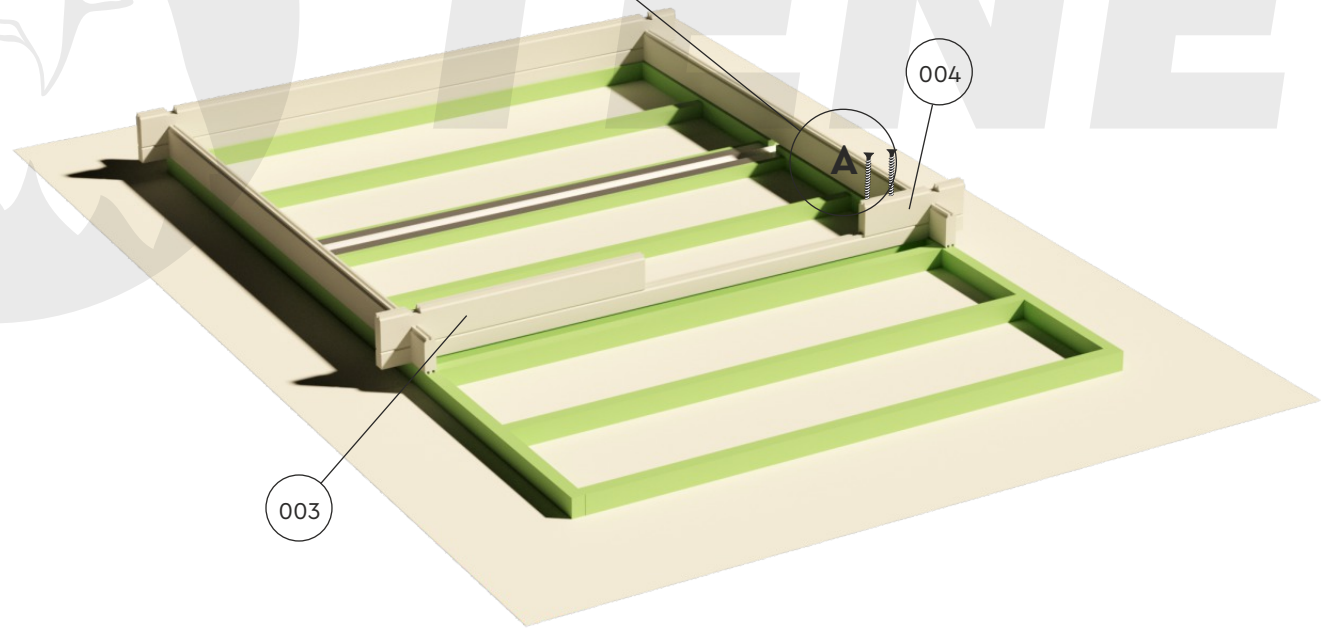

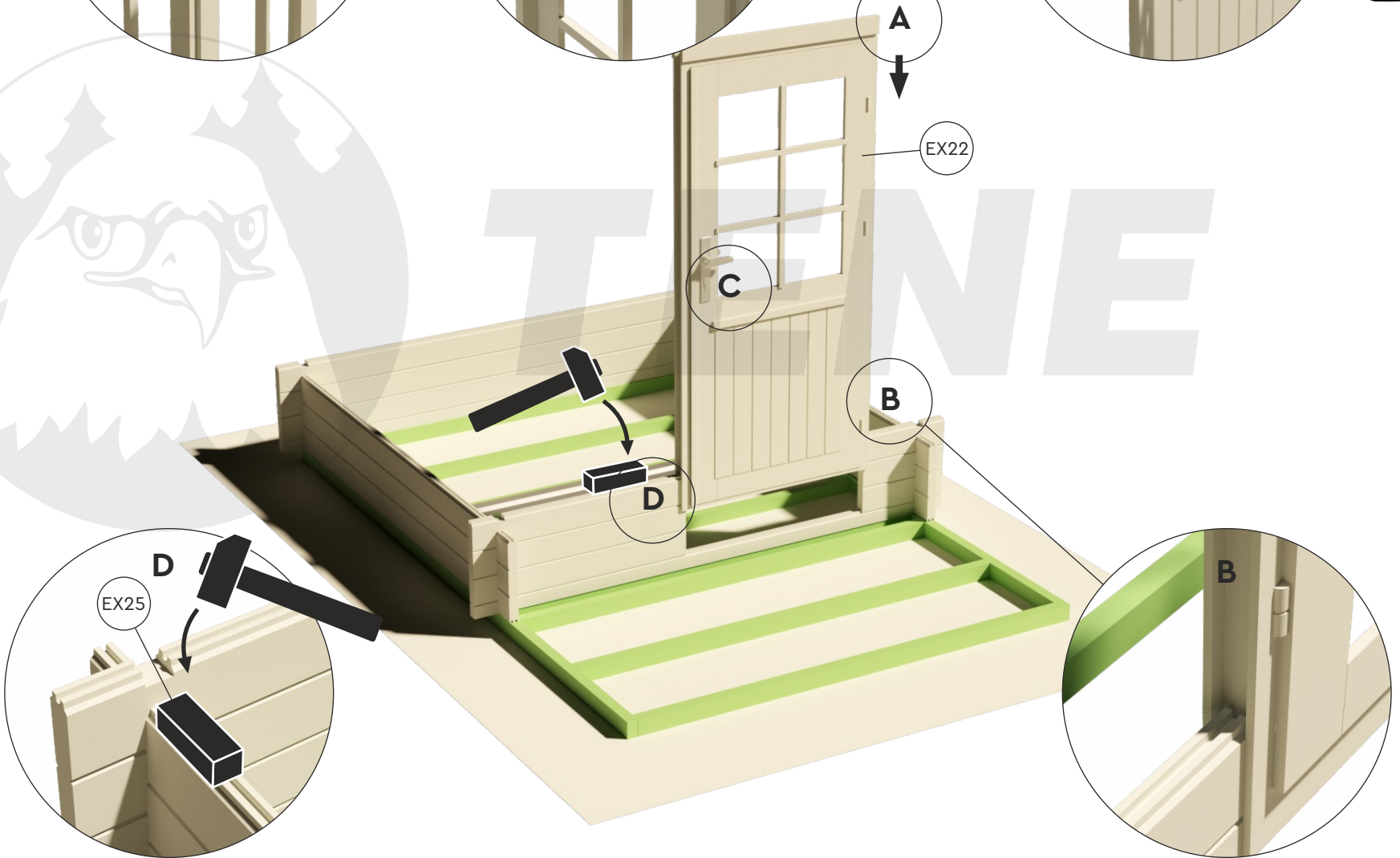
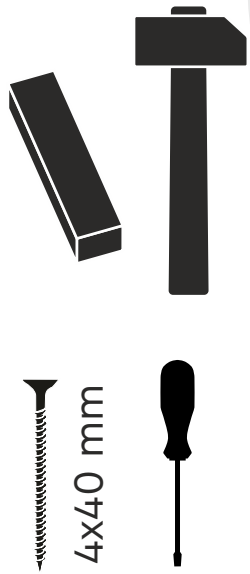
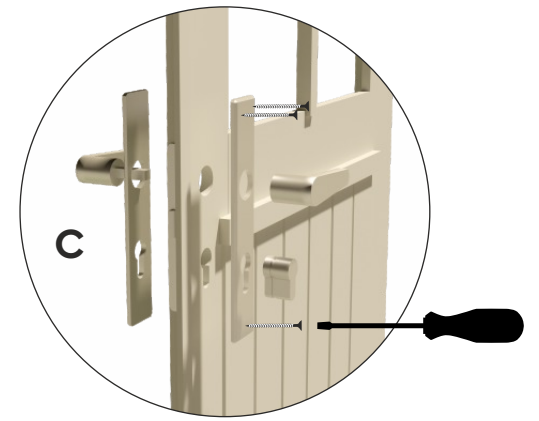
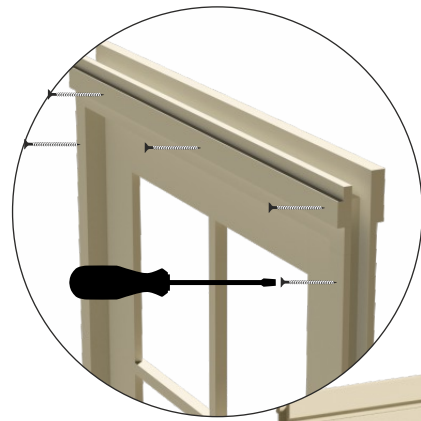
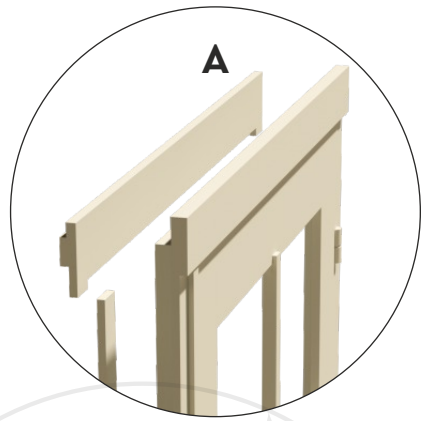

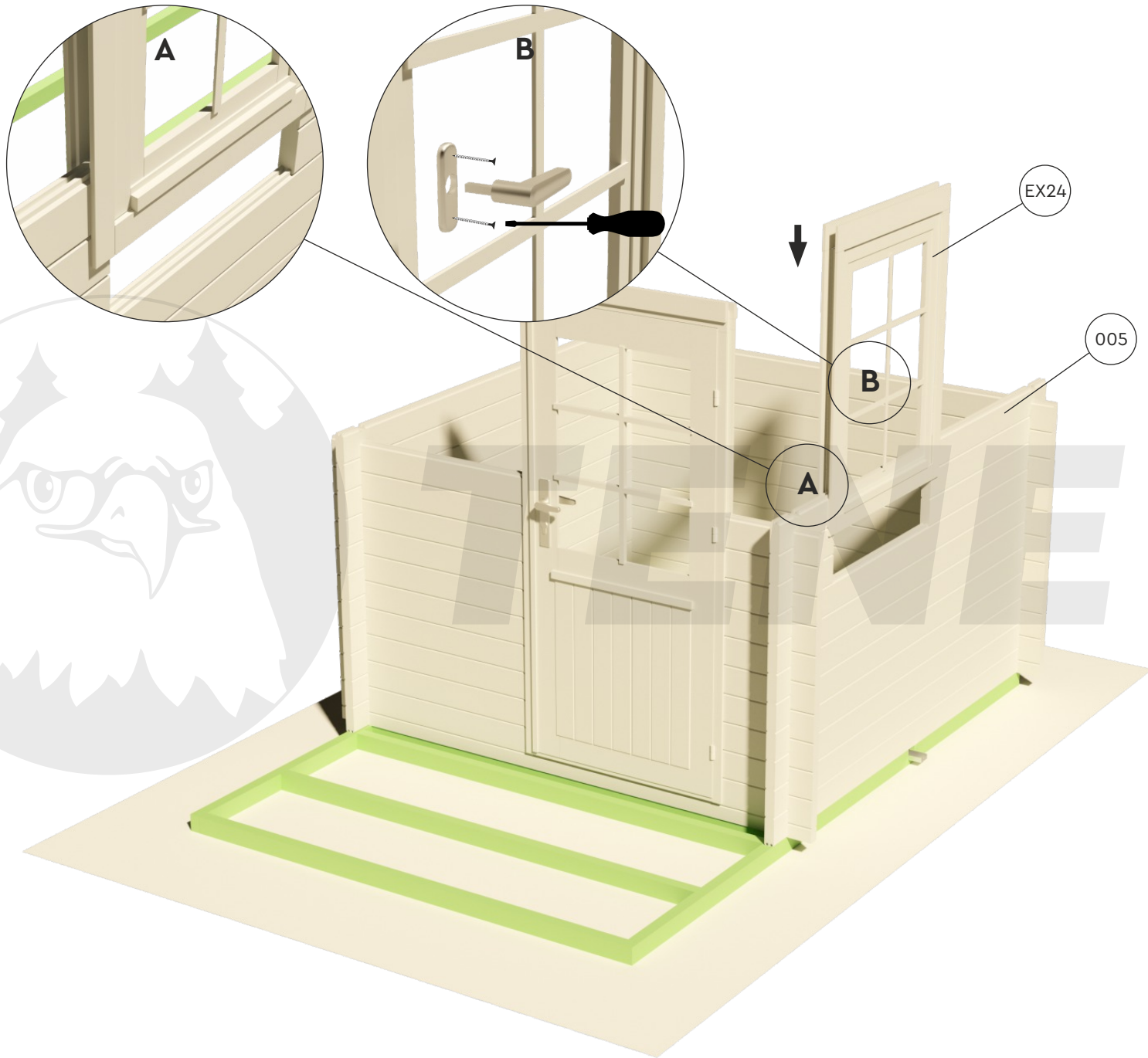



# NIKLAS 40

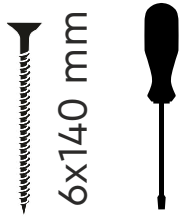
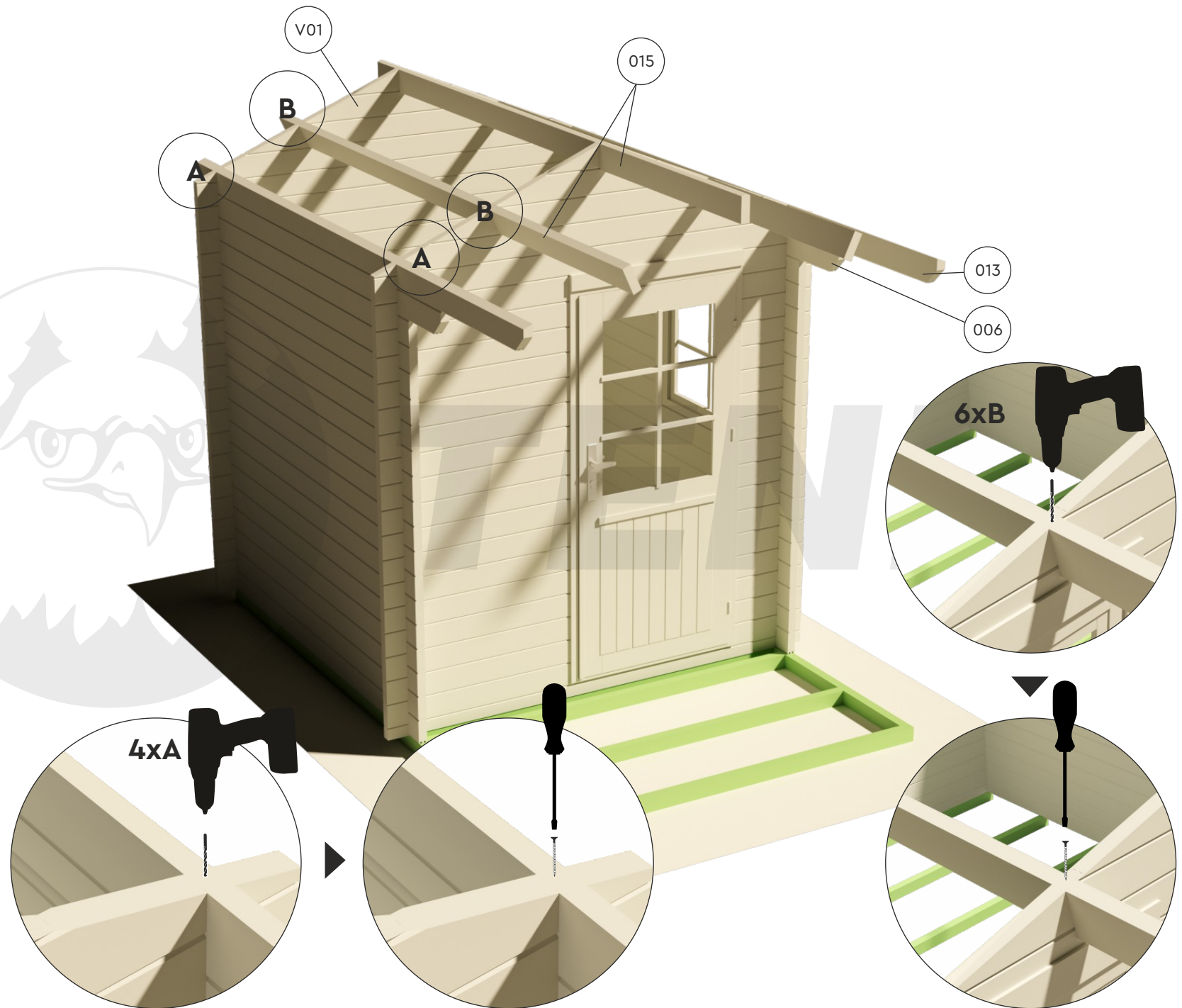





Ø 3 mm



4x50 mm

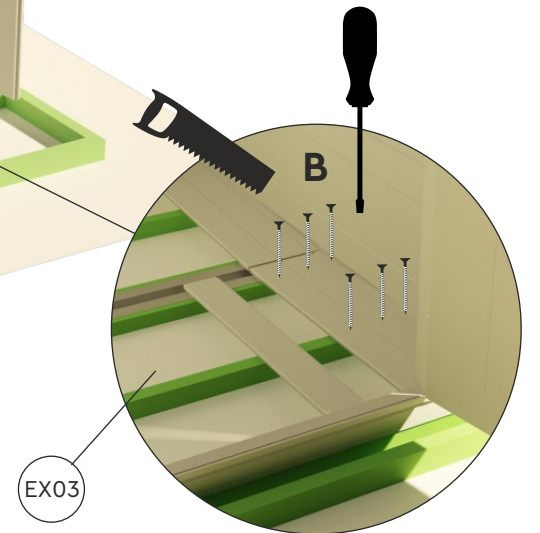
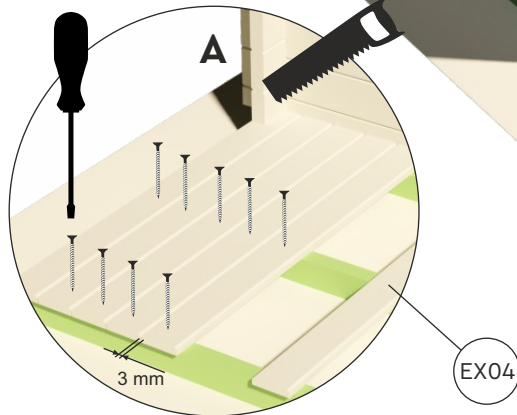
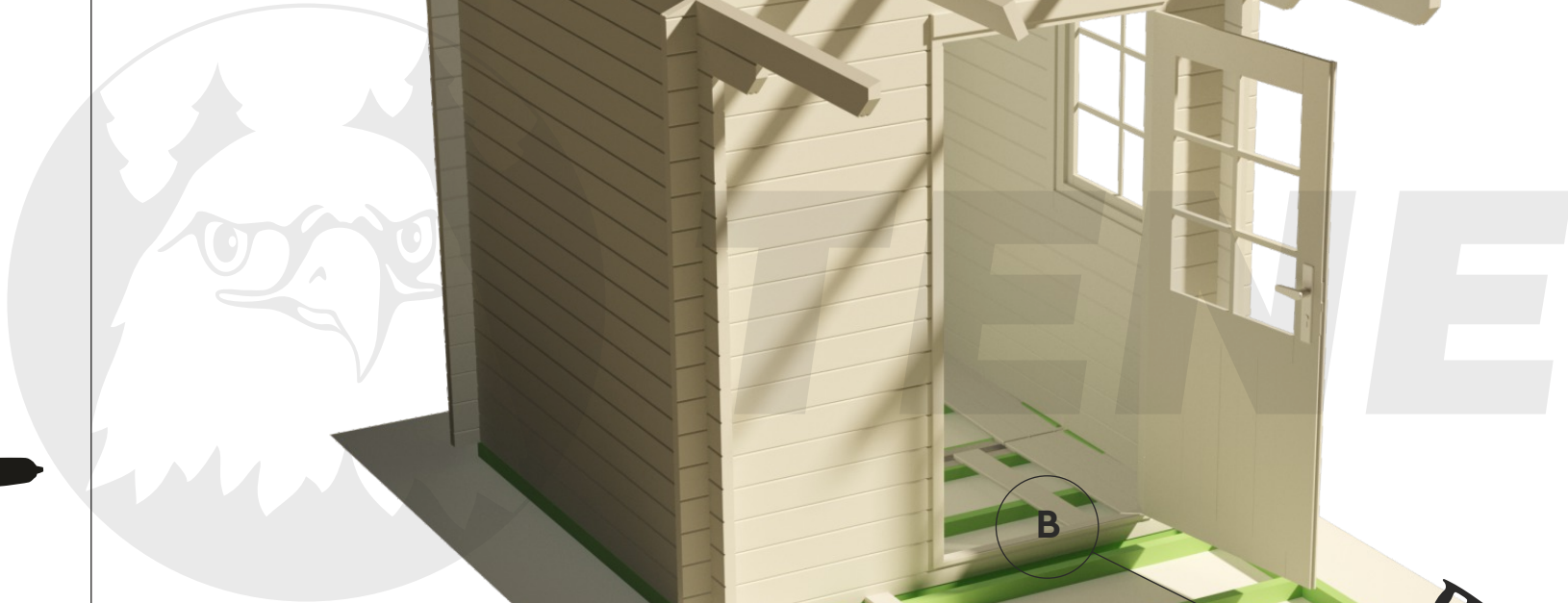

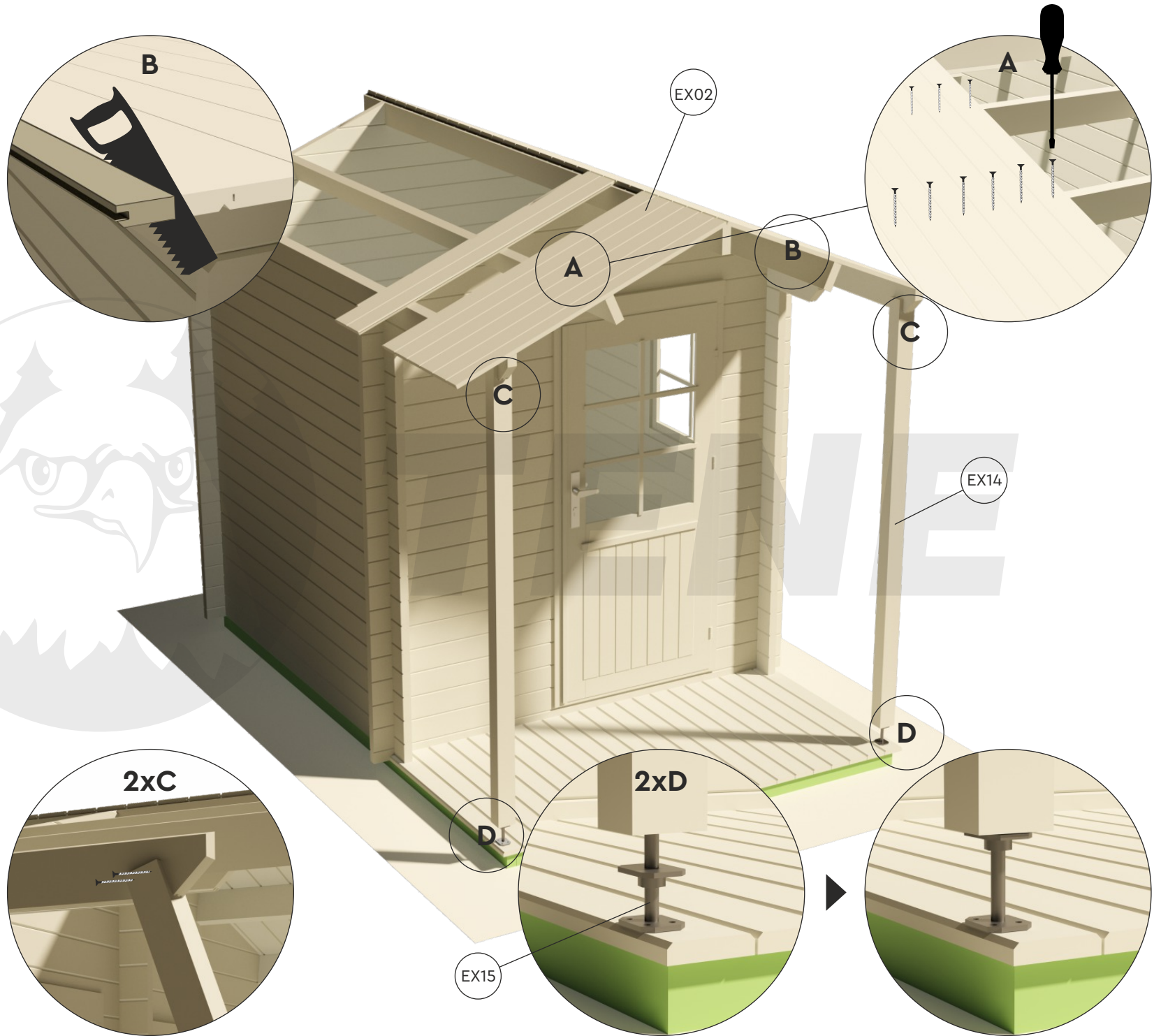

# NIKLAS 40

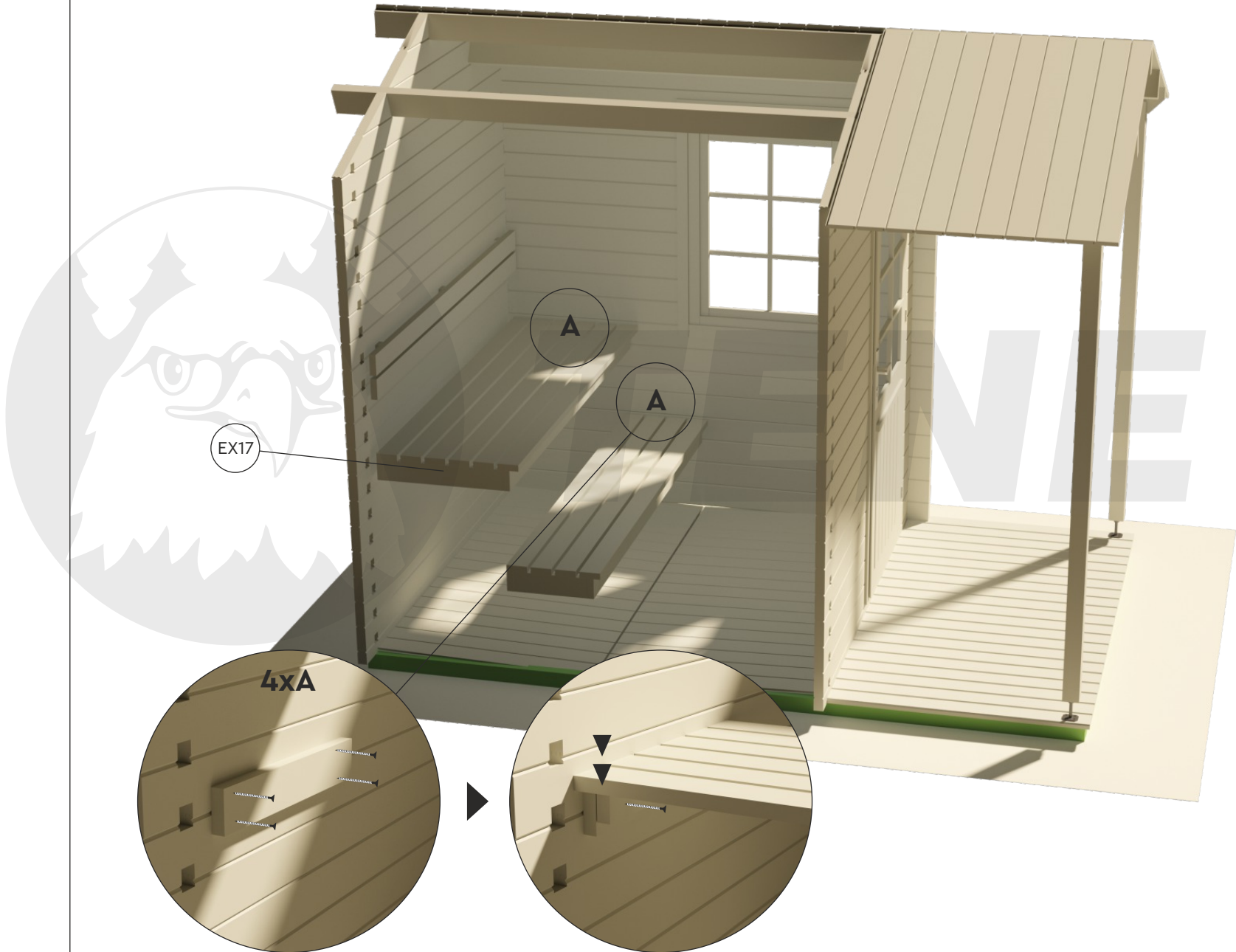



# NIKLAS 40

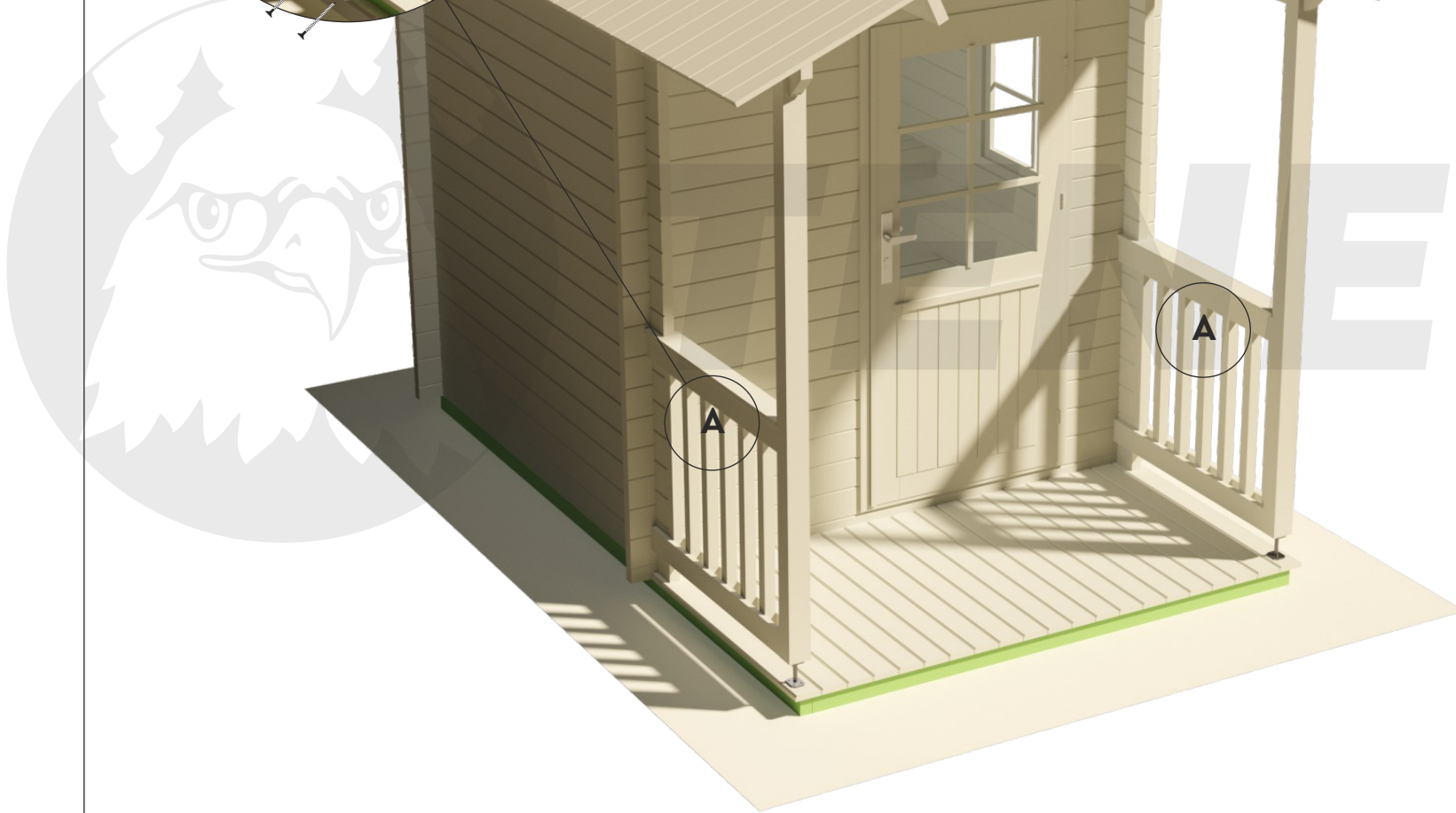
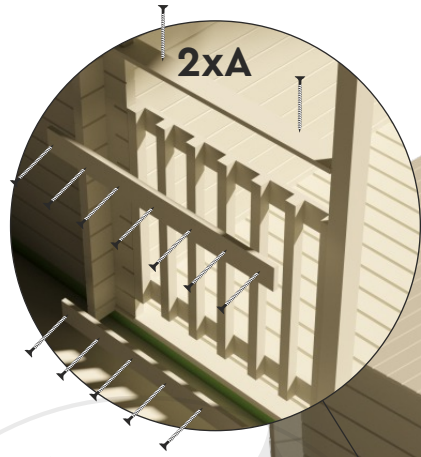

4x50 mm



# NIKLAS 40

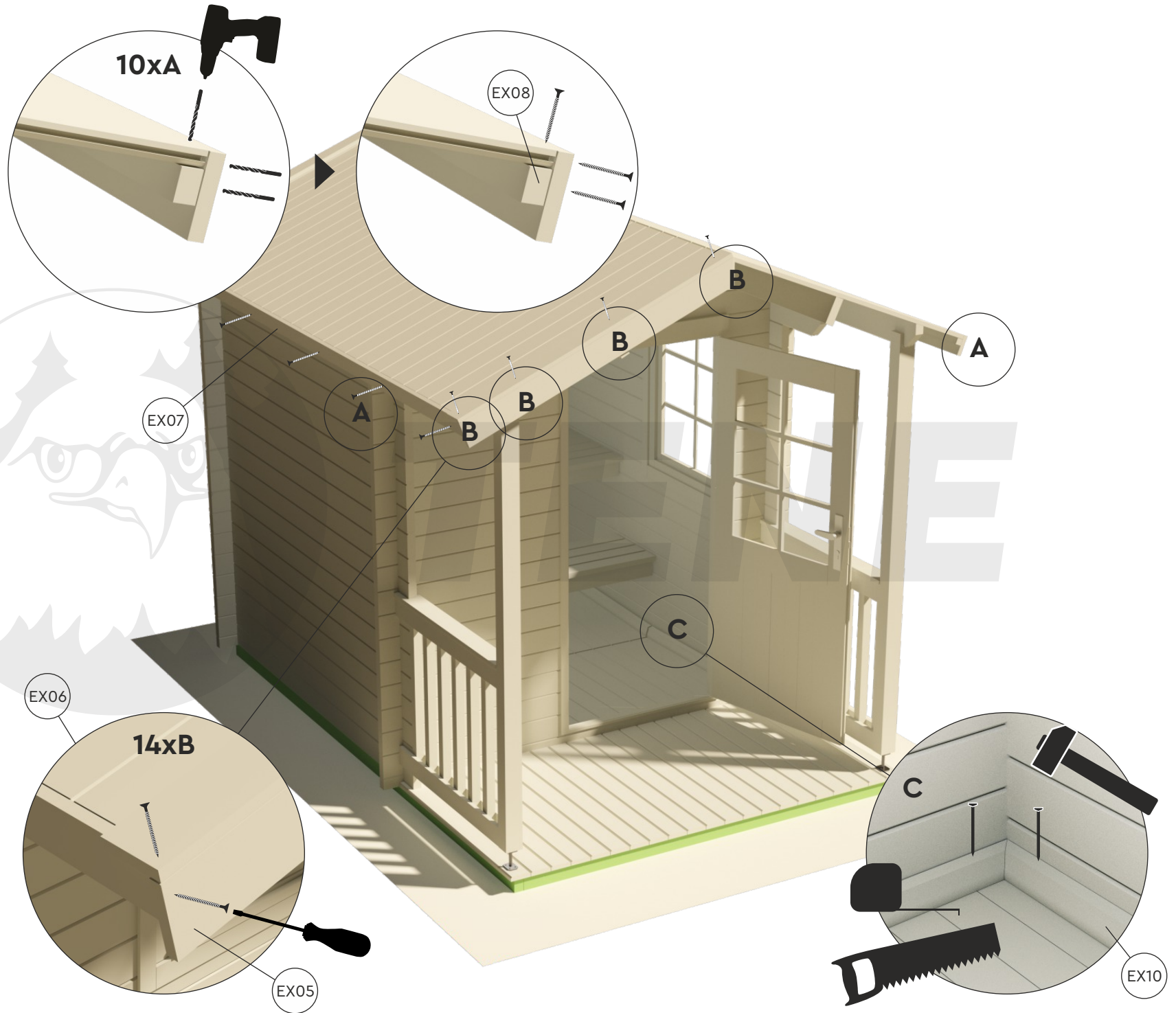

# NIKLAS 40

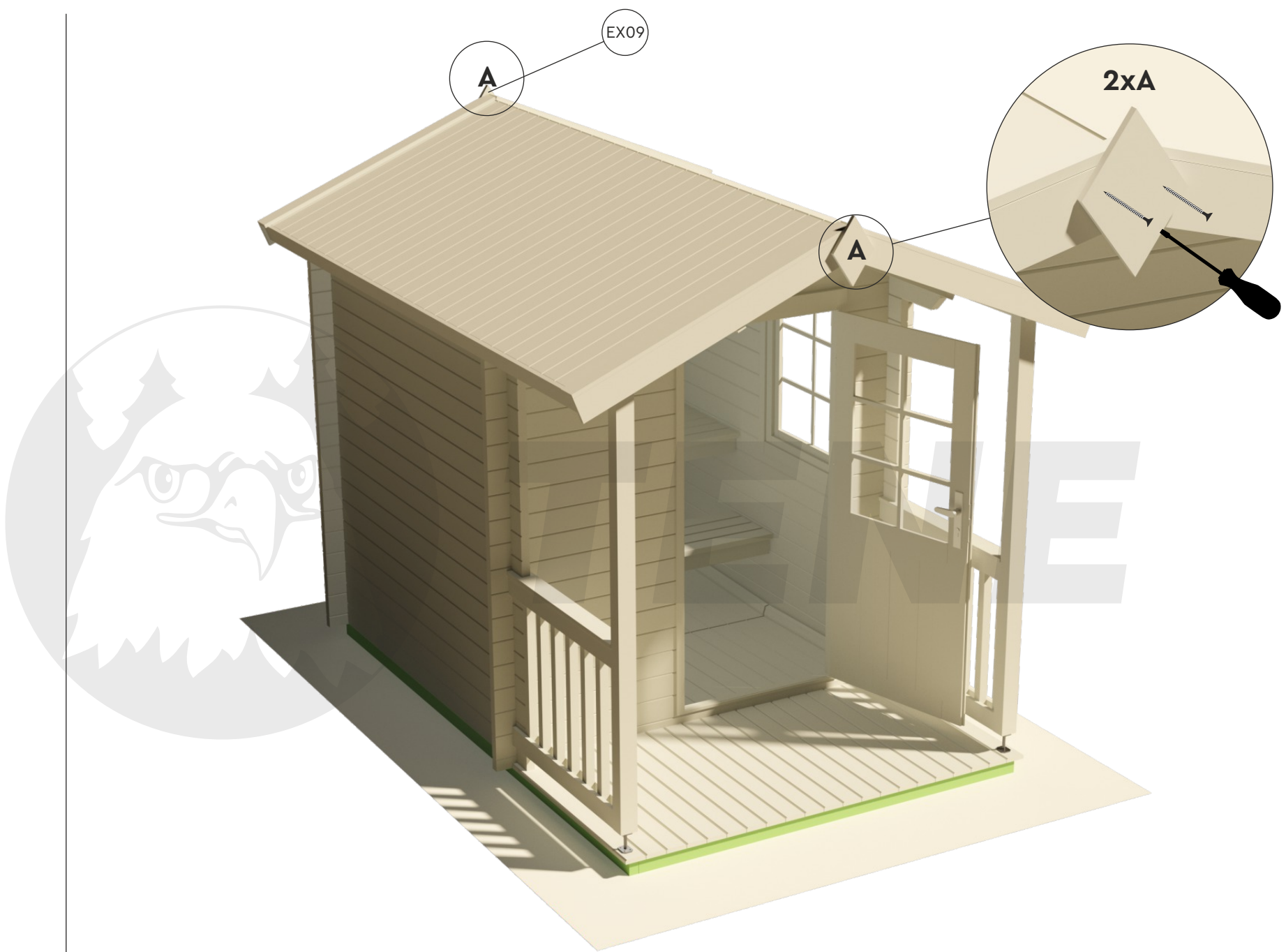

4x40 mm





# NIKLAS 40

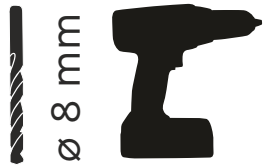
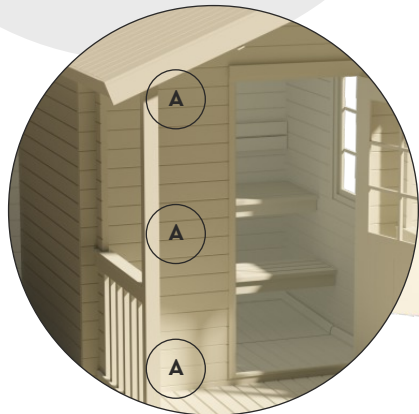
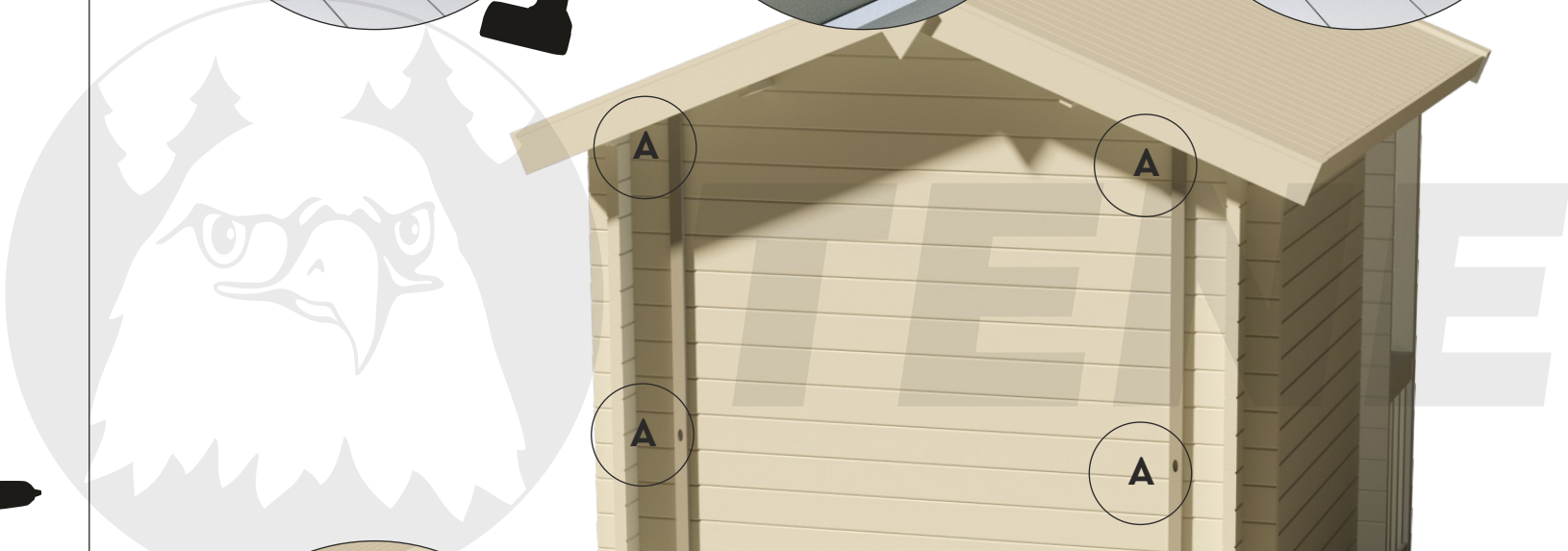
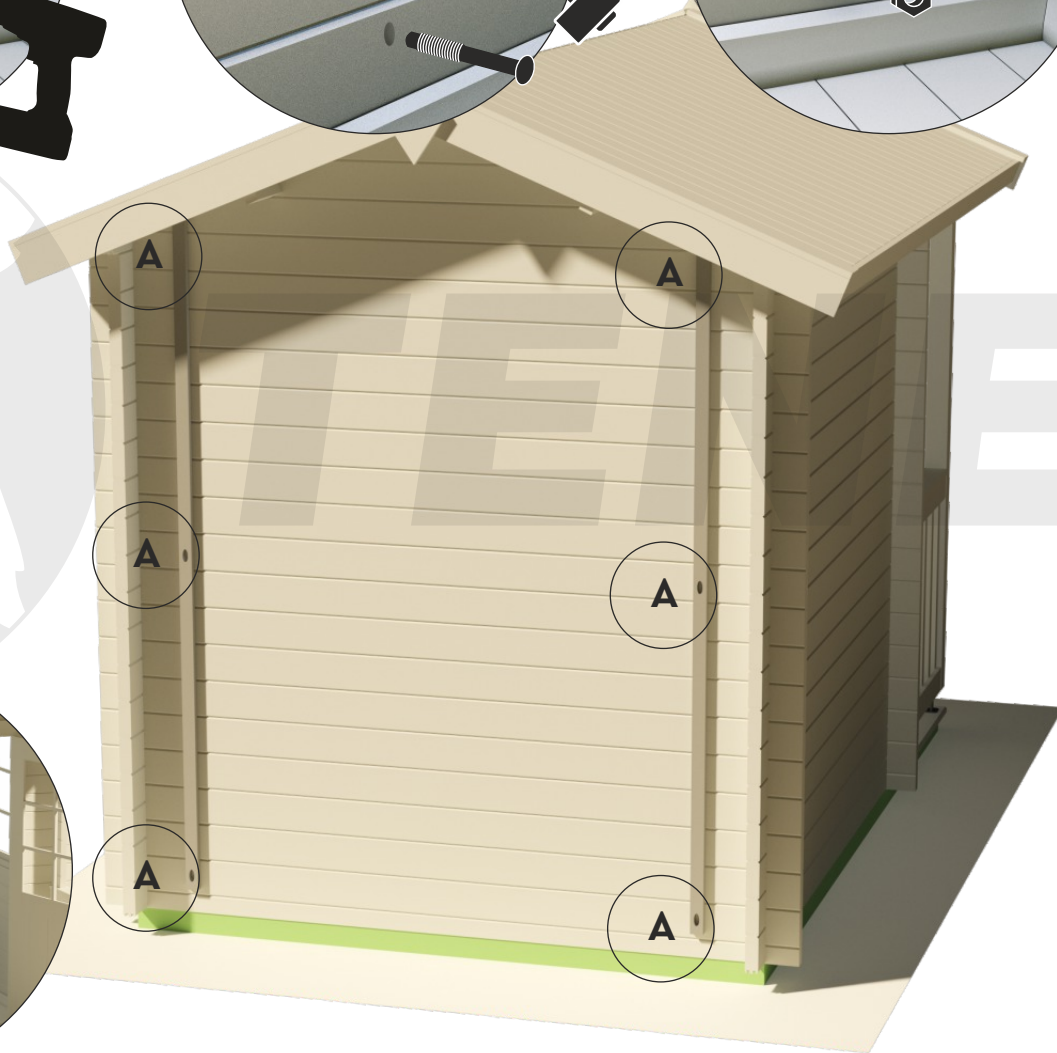
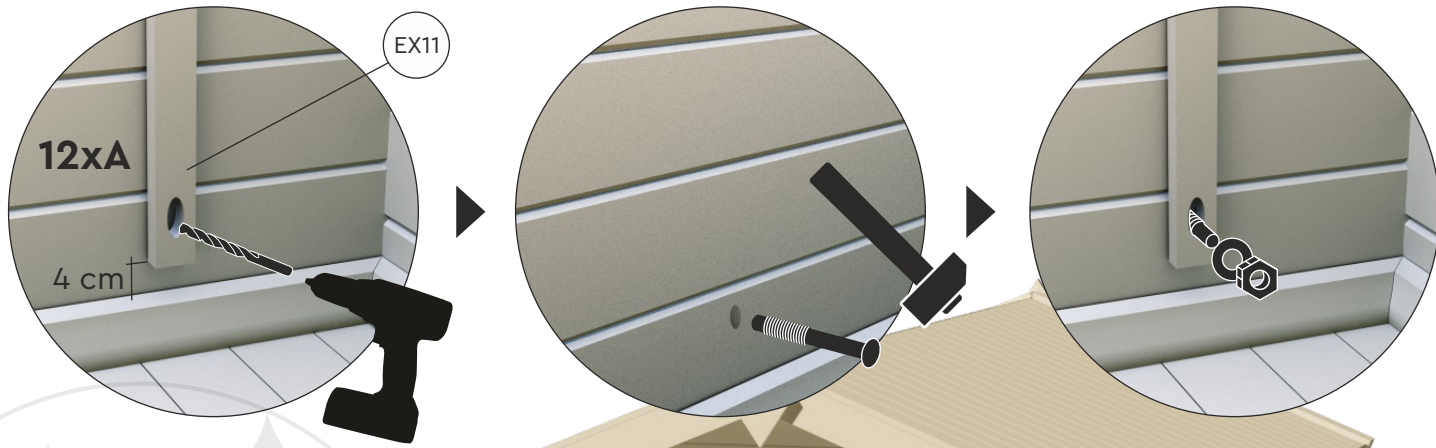

Ø 8 mm

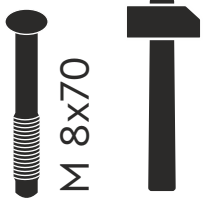

M 8x70

