

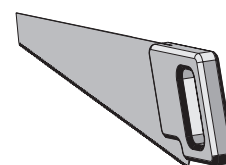

# 46742

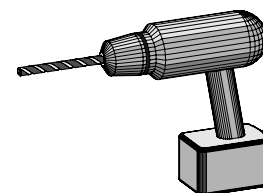

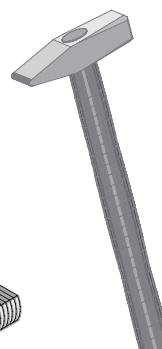
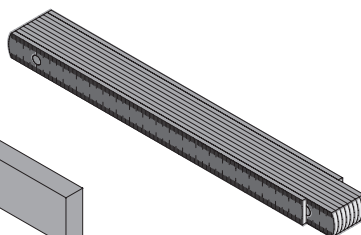
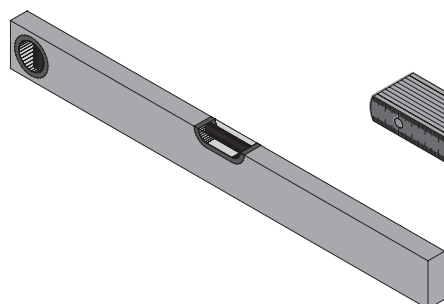

 **Aufbauanleitung**

 **notice de montage**

 **Building Instructions**

 **montagehandleiding**

 **Instrucciones de construcción**

 **Istruzioni per il montaggio**

 **Service-Hotline: +49 421 38693 33**

## Cinch Kabel mit Audiogerät verbinden

Bild 1



Lautsprecher mit Cinch-Kabel.

Bild 2

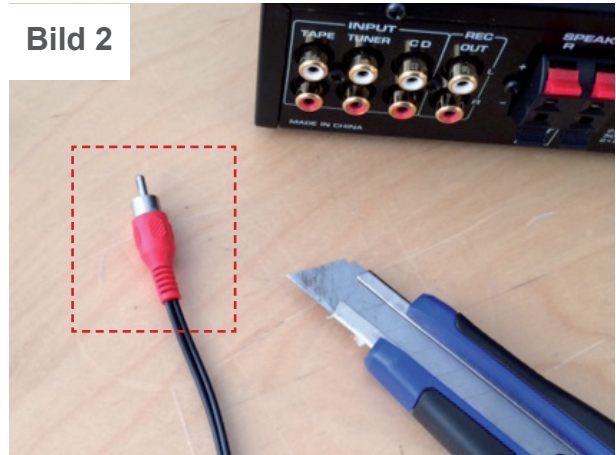

Mit einem Schneidecutter den Cinch-Stecker abtrennen.

Bild 3

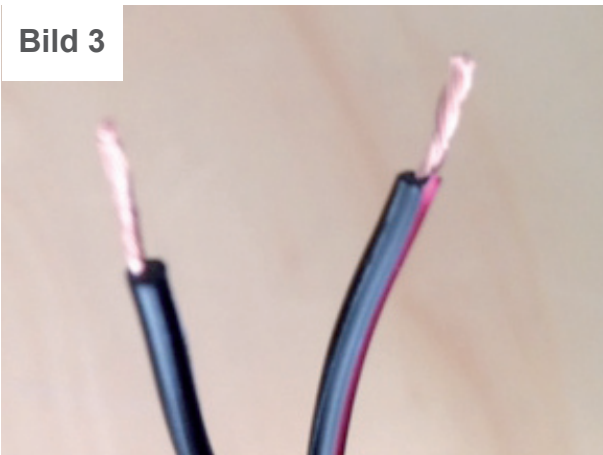

Das Kabel in zwei auftrennen und die Dichtung auf ca. 1 cm entfernen.

Bild 4



Zuletzt die gesplitteten Verbindungen mit dem Audiogerät „Speaker R“ und „Speaker L“ verbinden.