

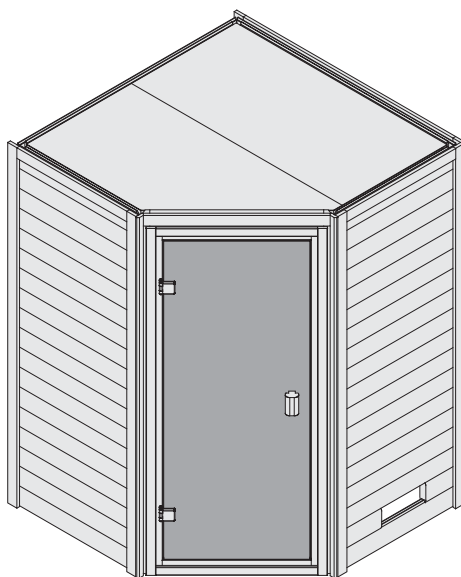

7764

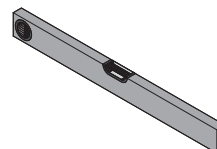

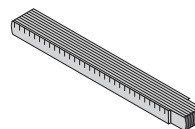

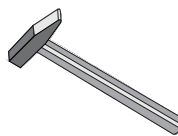
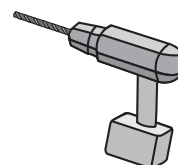
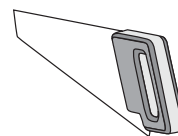

-  **Aufbauanleitung**
-  **Building Instructions**
-  **notice de montage**
-  **montagehandleiding**
-  **Montagevejledning**
-  **Instrucciones de construcción**
-  **Istruzioni per il montaggio**
-  **Montážní návod**
  
-  **info@karibu.de**











 Bitte bewahren Sie die Anleitung und den Garantieschein zur Seriennummer auf. Vernichten Sie diese erst nach Ablauf der Garantiezeit. Eventuelle Beanstandungen können mithilfe der Stückliste einfacher zugeordnet werden.





Beigelegte Dokumente:

- Informationsheft
- Garantieschein zur Seriennummer
- Typenschild inkl. Warnhinweise (Sauna)
- ggf. Zubehör-Anleitungen in externen Paketen

- \*  Nicht im Lieferumfang enthalten  
 Not included  
 Non comprises dans la livraison  
 Niet bijgeleverd



-  No forman parte del suministro  
 Non incluso  
 V ceně není zahrnuto  
 Ikke inkluderet

- 1  Länge muss ermittelt und zugesägt werden  
 Length must be determined and sawn  
 La longueur doit être déterminée et sciée  
 De lengte moet worden bepaald en worden gezaagd

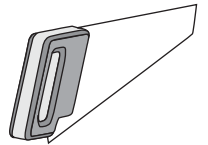
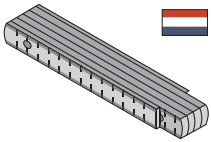
-  La longitud debe ser determinada y aserrada  
 La lunghezza deve essere determinata e segata  
 Délka musí být určena a rozřezána  
 Længden skal bestemmes og saves



- 2  Nicht gebraucht  
 Not needed  
 Pas nécessaire  
 Niet nodig



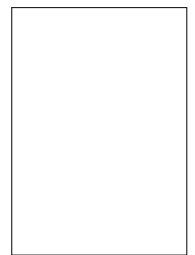

-  No es necesario  
 Non necessario  
 Není nutná

- 3  mit Zubehör!  
 met toebehoren!  
 with accessories!  
 avec accessoires!





-  con accesorios!  
 con accessori!  
 s příslušenstvím!  
 z dodatki!



- 4  Fixiert vorübergehend  
 tijdelijk vast  
 Fixed temporarily  
 temporairement fixe

-  temporalmente fijo  
 temporaneamente fisso  
 dočasně pevný  
 Zčasno pritrjeno

- 5  Bestand vom Haus  
 Inventaris van het huis  
 Inventory of the house  
 Inventaire de la maison

-  Inventario de la casa  
 Inventario della casa  
 Inventář domu  
 Inventar hiše

Werkzeuge / Tools\*

X

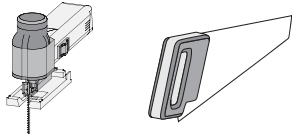

X

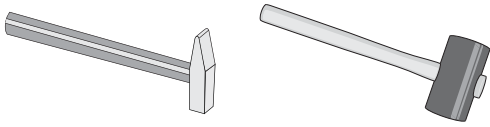

X

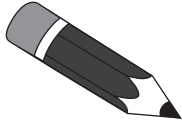

X

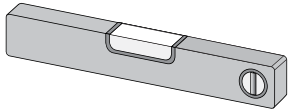

X

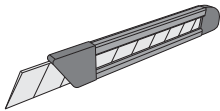

X

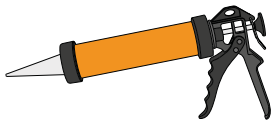
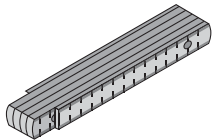

X

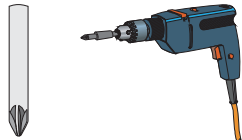

X

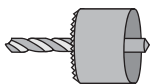
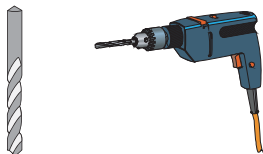

X



Technische Daten

In der Auftragsbestätigung bzw. Lieferschein ist der gekaufte Ofentyp bzw. das erworbene Steuergerät zu finden. Bitte entnehmen Sie die technischen Daten Ihrer Geräte der folgenden Auflistung

Gerät	Netzspannung	Wattage
<b>Öfen</b>		
9kW Ofen Bio	400V ~ 3N	9kW
9kW Ofen (Finnisch)	400V ~ 3N	9kW
9kW Ofen integr. Steuerung	400V ~ 3N	9kW
4,5kW Ofen Bio	400V ~ 3N	4,5kW
4,5kW Ofen (Finnisch)	400V ~ 3N	4,5kW
4,5kW Ofen integr. Steuerung	400V ~ 3N	4,5kW
3,6kW Ofen Bio	230V ~ 1N	3,6kW
3,6kW Ofen (Finnisch)	230V ~ 1N	3,6kW
3,6kW Ofen integr. Steuerung	230V ~ 1N	3,6kW
<b>Steuergeräte</b>		
externe Steuerung Easy Bio	400V ~ 3N	max. 10,8kW
externe Steuerung Plug&Play Bio	240V ~ 3N	max. 10,8kW
externe Steuerung (Finnisch)	400V ~ 3N	max. 10,8kW
externe Steuerung Plug&Play (Finnisch)	240V ~ 3N	max. 10,8kW
Multisteuergerät	400V ~ 3N	max. 10,5kW
externe Steuerung Classic Bio	400V ~ 3N	max. 9kW
externe Steuerung Classic (Finnisch)	400V ~ 3N	max. 9kW
externe Steuerung Premium Bio	400V ~ 3N	max. 12kW
externe Steuerung Premium (Finnisch)	400V ~ 3N	max. 9kW



Vergleichen Sie zuerst die Material-liste mit Ihrem Paketinhalt! Bitte haben Sie Verständnis, dass Beanstandungen nur im nicht aufgebauten Zustand bearbeitet werden können!



Vergelijk eerst de lijst van materialen met de inhoud van uw pakket! Reclamaties kunnen alleen in behandeling worden genomen zolang de onderdelen nog niet zijn gemonteerd!



Confrontate questa distinta materiali prima con il contenuto del pacchetto! Vi preghiamo di comprendere che eventuali reclami possono essere accolti solo prima del montaggio!



First compare the list of materials with your package contents! Please understand that complaints can be processed in the non-built status only!



Start med at kontrollere materialelisten med indholdet af den leverede pakke! Vi gør venligst opmærksom på at reklamationer kun kan behandles for materialer som ikke er blevet bearbejdet!



Nejprve překontrolujte obsah balení podle materiálového listu! Mějte pochopení pro to, že případnou reklamaci se můžeme zabývat pouze tehdy, když díly nebudou smontované! Za pomoci tohoto seznamu můžete jednotlivé díly přiřadit k montážnímu návodu.



Commencez par comparer la liste du matériel avec le contenu de votre paquet! Sachez que nous traitons uniquement les réclamations concernant le matériel à l'état non monté!



En primer lugar, compare la lista de material con el contenido del paquete. Rogamos entienda que las reclamaciones sólo pueden ser tramitadas antes de montar el objeto!

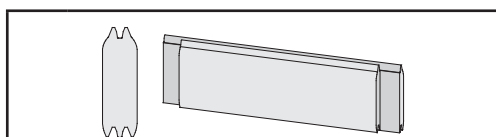
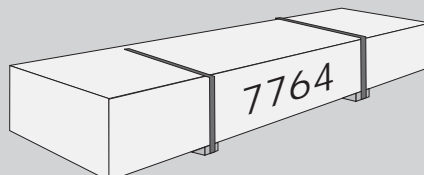

35 x A1	777 x 121 x 38 mm	ID 26726
35 x A2	1380 x 121 x 38 mm	ID 26573

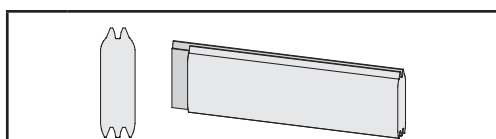

1 x A3	200 x 121 x 38 mm	ID 80382
--------	-------------------	----------

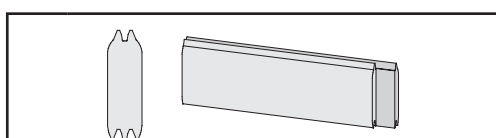

1 x A4	297 x 121 x 38 mm	ID 26725
--------	-------------------	----------

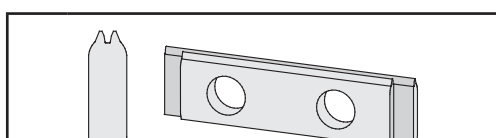

1 x A5	1380 x 121 x 38 mm	ID 21867
--------	--------------------	----------

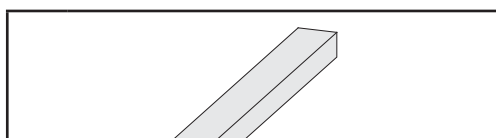

1 x B1	1920 x 20 x 3 mm	ID 20799
2 x B2	1309 x 90 x 16 mm	ID 72925
1 x B3	850 x 58 x 17 mm	ID 48544
6 x B4	2000 x 58 x 17 mm	ID 48541
2 x B5	250 x 45 x 18 mm	ID 26716
2 x B6	550 x 45 x 18 mm	ID 26717
2 x B7	705 x 45 x 18 mm	ID 22937
2 x B8	800 x 45 x 18 mm	ID 24796
1 x B9	880 x 45 x 18 mm	ID 21440
2 x B10	1308 x 45 x 18 mm	ID 26580
1 x B11	300 x 95 x 18 mm	ID 19130
4 x B12	480 x 95 x 18 mm	ID 20930

4 x B13	565 x 95 x 18 mm	ID 15498
2 x B14	800 x 58 x 28 mm	ID 15493
3 x B15	1916 x 36 x 36 mm	ID 21431
1 x B16	781 x 78 x 38 mm	ID 56718

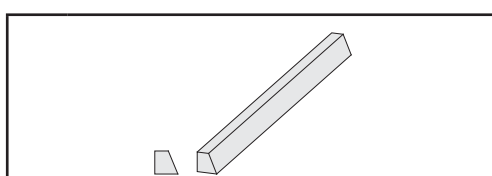

2 x C1	1916 x 36 x 36 mm	ID 21814
2 x C2	1973 x 36 x 36 mm	ID 21825

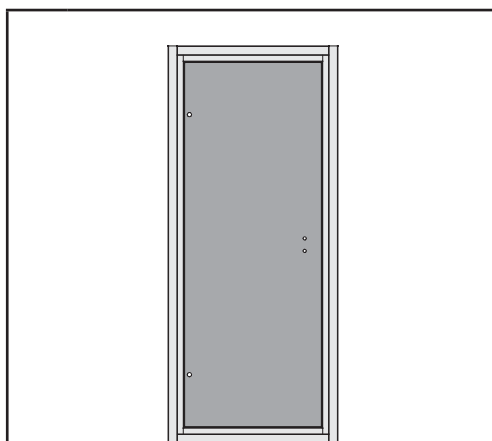

1 x D1		ID 26500
--------	--	----------

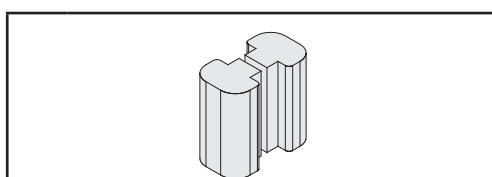

1 x D2		ID 26183
--------	--	----------

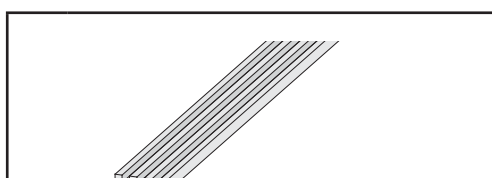

1 x E1	1820 x 140 x 26 mm	ID 26480
--------	--------------------	----------

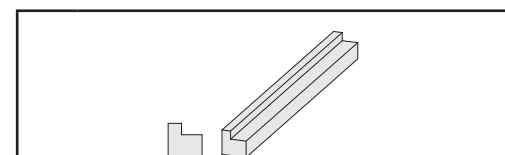

2 x E2	250 x 45 x 45 mm	ID 3863
2 x E3	555 x 45 x 45 mm	ID 40301

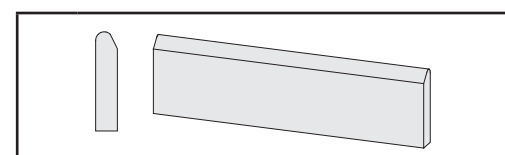

2 x G1	2000 x 58 x 17 mm	ID 48545
--------	-------------------	----------

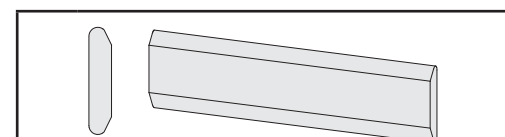

2 x G2	2100 x 40 x 18 mm	ID 80276
--------	-------------------	----------

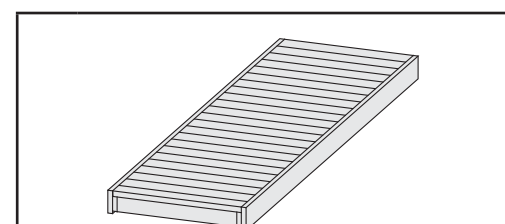

1 x L1	1309 x 250 x 90 mm	ID 52066
1 x L2	1309 x 550 x 90 mm	ID 52064

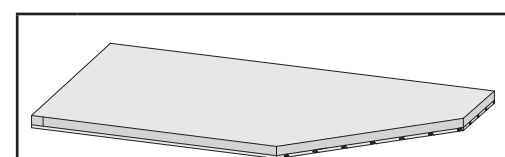

1 x M1	1338 x 666 x 55 mm	ID 26582
--------	--------------------	----------



1 x M2	1338 x 666 x 55 mm	ID 26581
--------	--------------------	----------

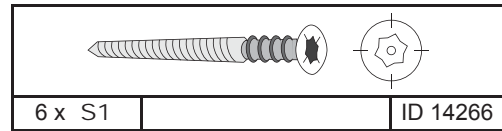
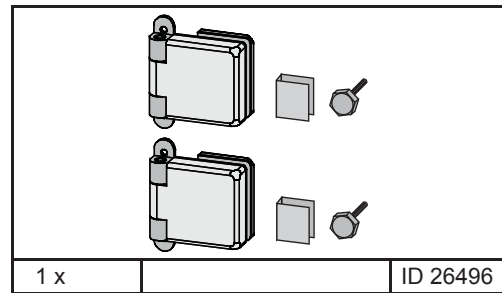
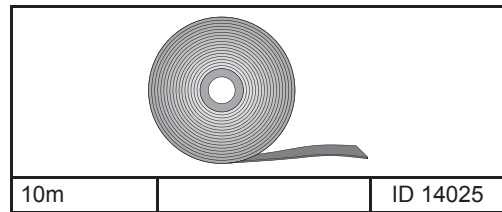

20 x	4 x 30mm	ID 3686
60 x	4 x 35mm	ID 3687
350 x	4 x 40mm	ID 21925
30 x	4 x 50mm	ID 3688
25 x	4,5 x 80mm	ID 9204
20 x	6 x 80mm	ID 47558
80 x	6 x 90mm	ID 26715

60 x	4,5 x 40mm	ID 26285

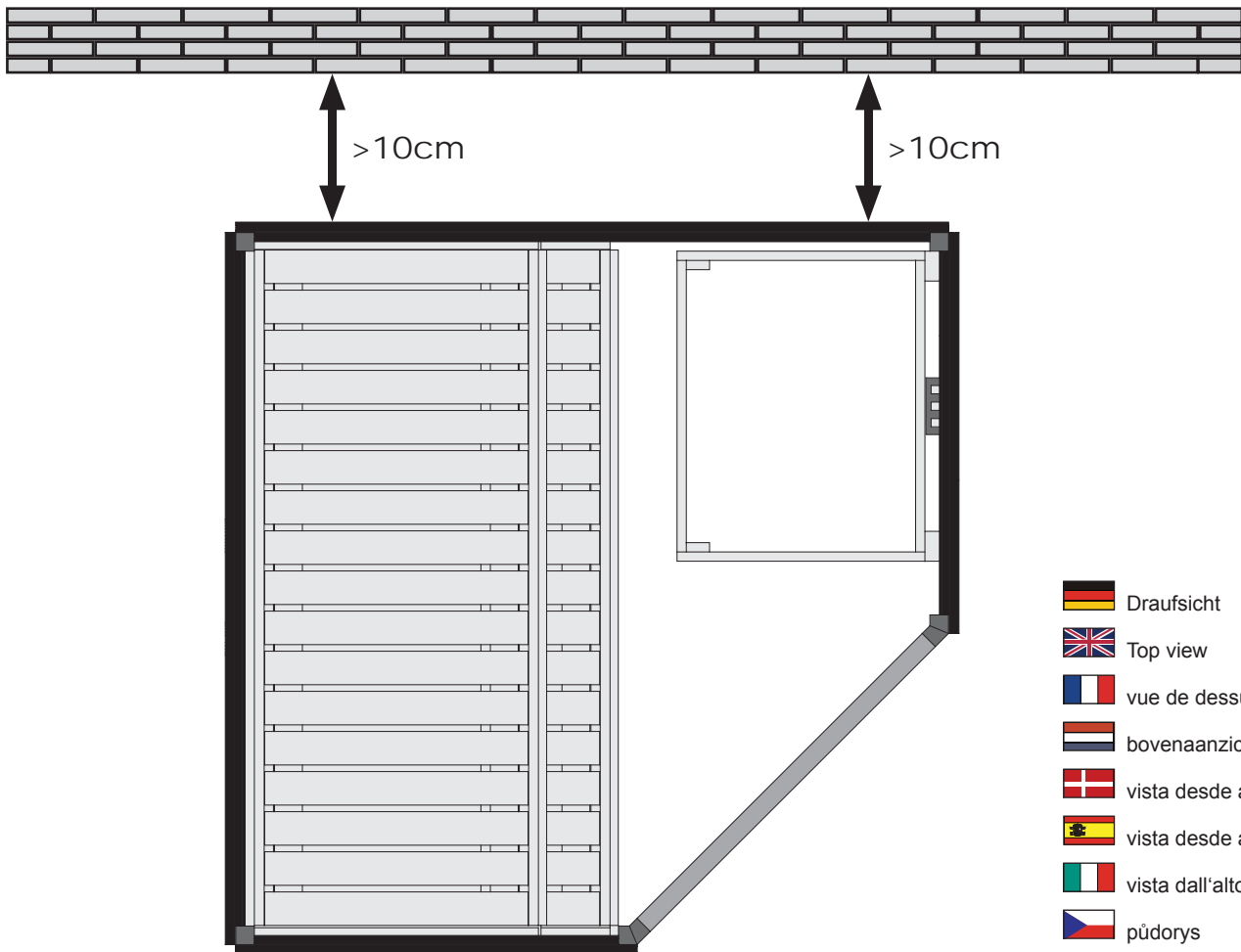

60 x S1	4 x 30mm	ID 26116
6 x S2	12 x 18mm	ID 46403

6 x	3 x 16mm	ID 46376
1 x		ID 50420







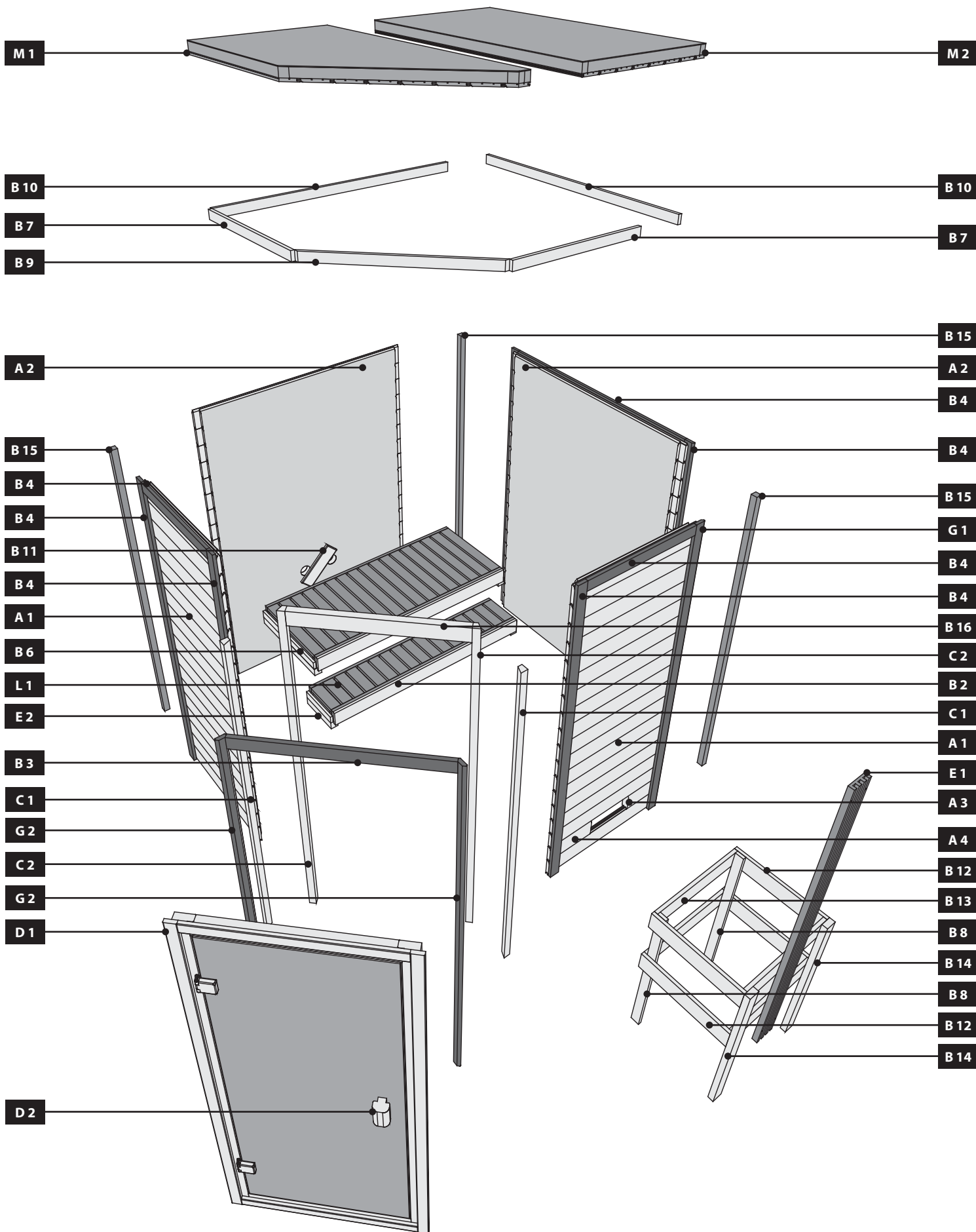

 Übersicht  
 Overview  
 enquête



 overzicht  
 undersøgelse  
 estudio

 sondaggio  
 přehled



 Achten Sie auf die gleiche Höhe  
 Look for the same height  
 Faites attention à la même hauteur

 Besteed aandacht aan de dezelfde hoogte  
 Prestar atención a la misma altura  
 Prestare attenzione alla stessa altezza

 Dávejte pozor na stejnou výšku  
 Vær opmærksom på samme højde

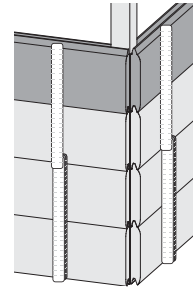
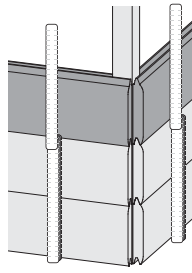
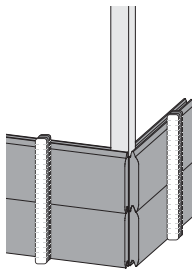

01

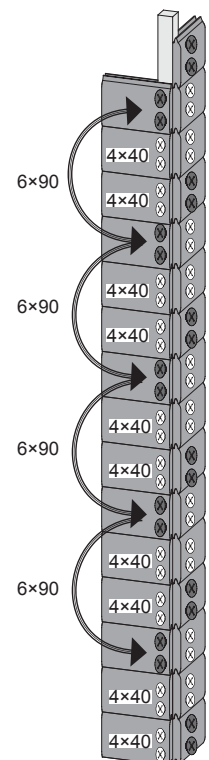
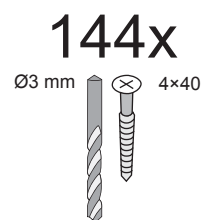
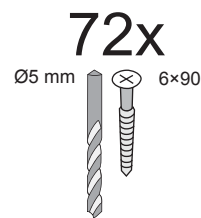
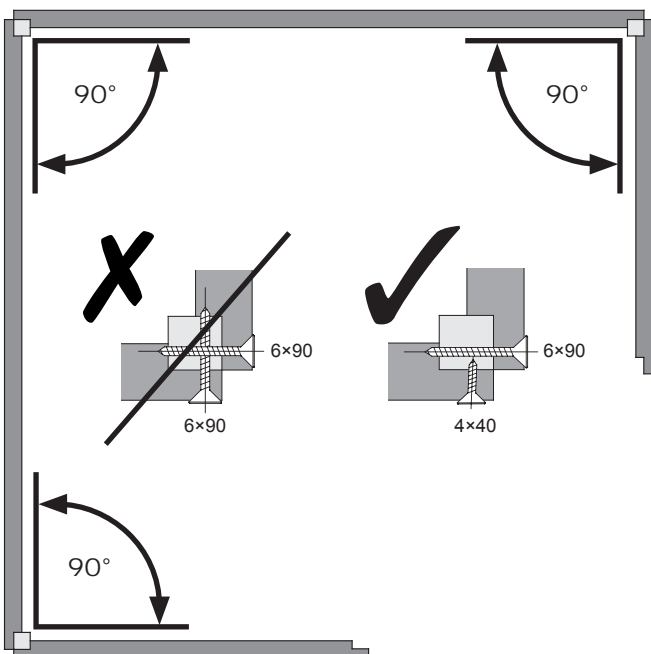
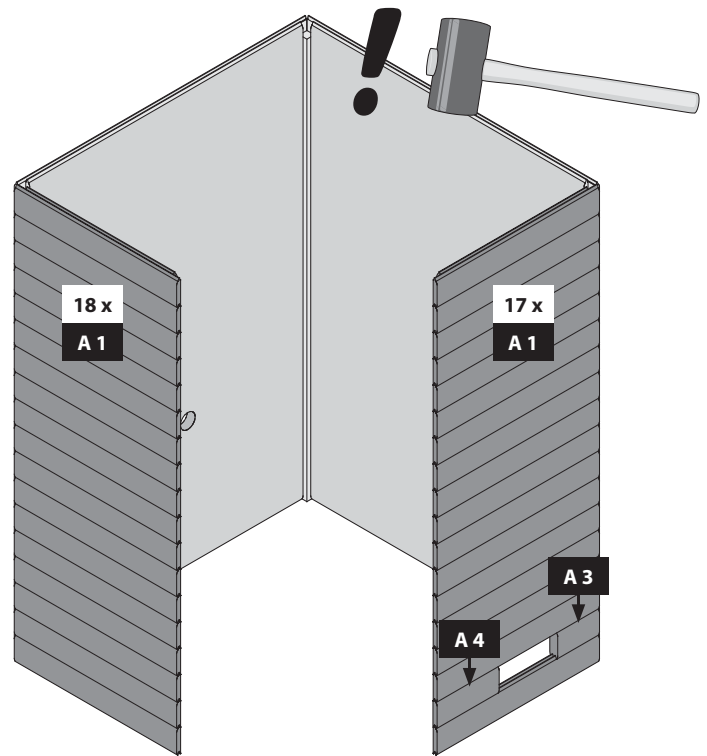
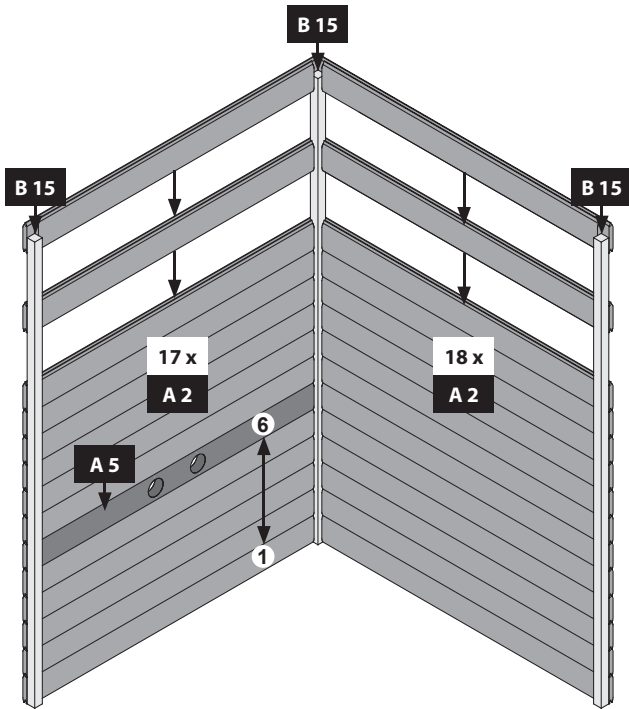

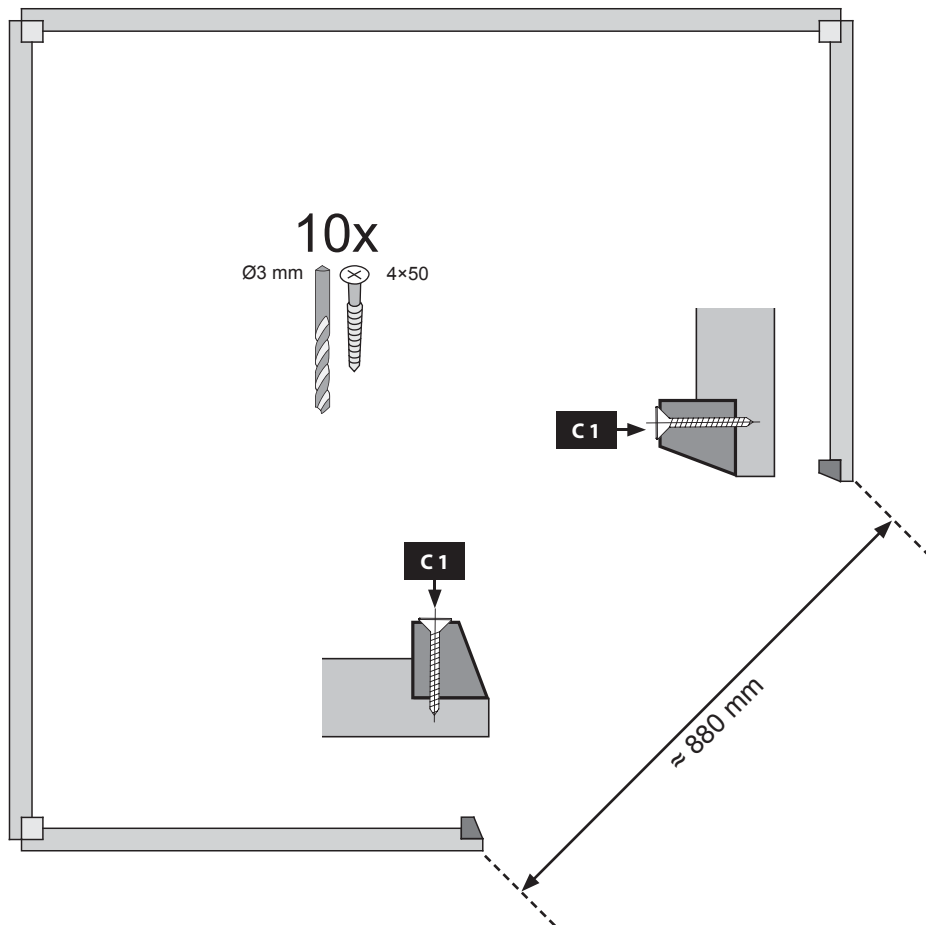
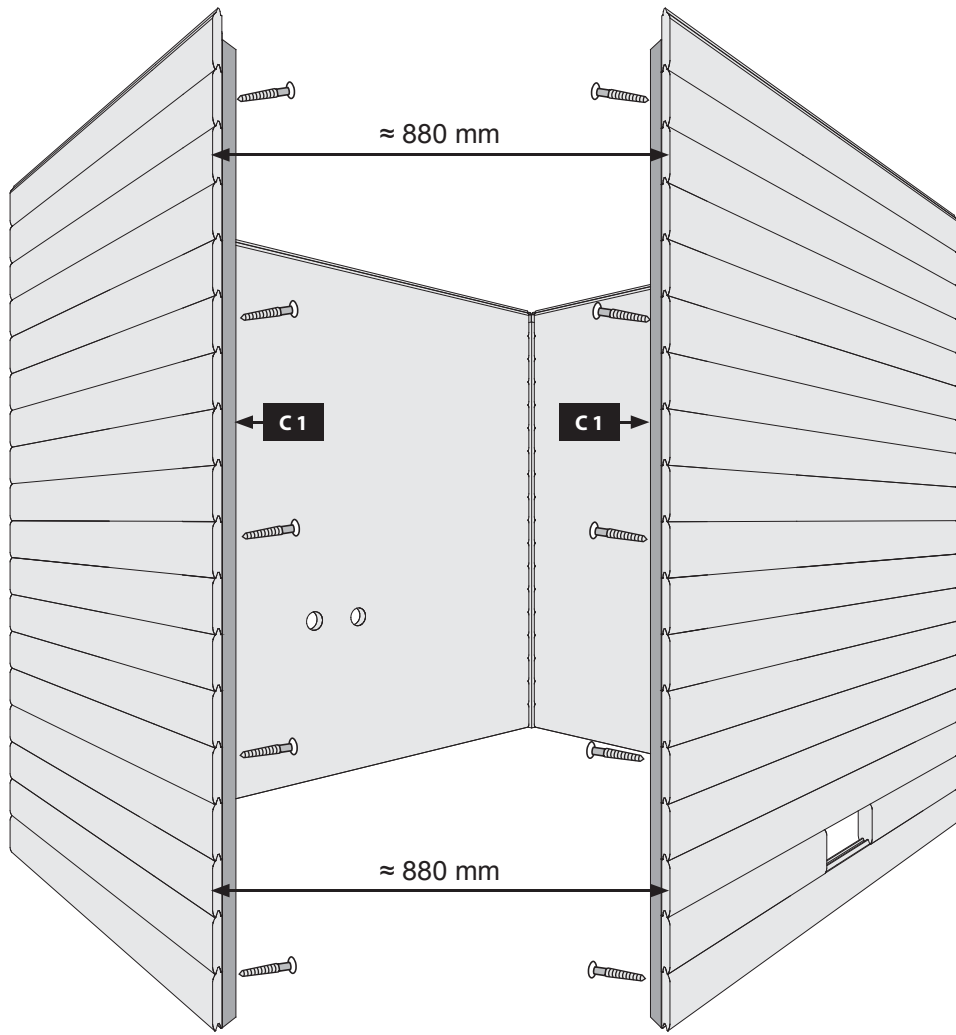







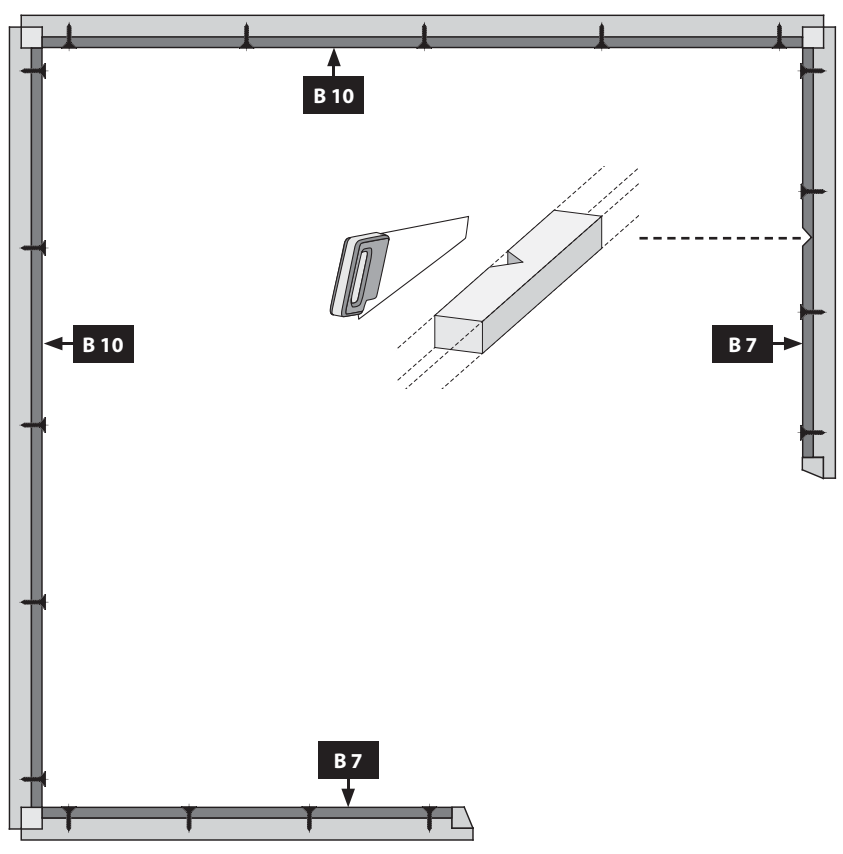
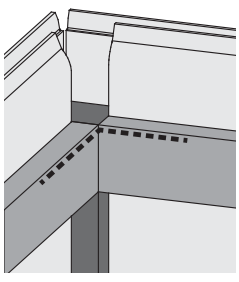

18x  
Ø3 mm 4x40

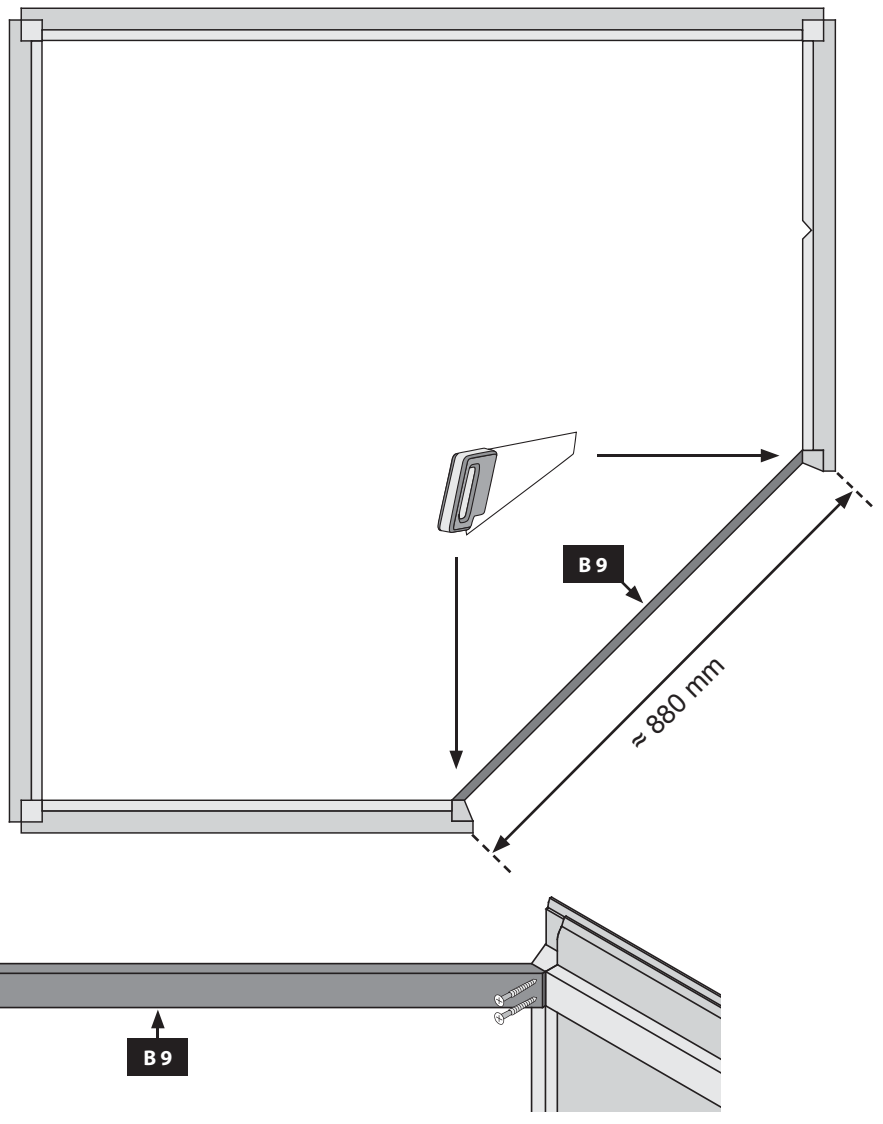

- Bündig!
- Flush!
- Affleurement!
- Gelijk!
- I flugt!
- Aras!
- Combacia!
- Stejný!





4x  
Ø3 mm 4x40



 Sauna Dichtband  
 Sauna sealing tape  
 Ruban d'étanchéité pour sauna

 Sauna tætningsbånd  
 Sauna afdichtingstape  
 Cinta de sellado de sauna



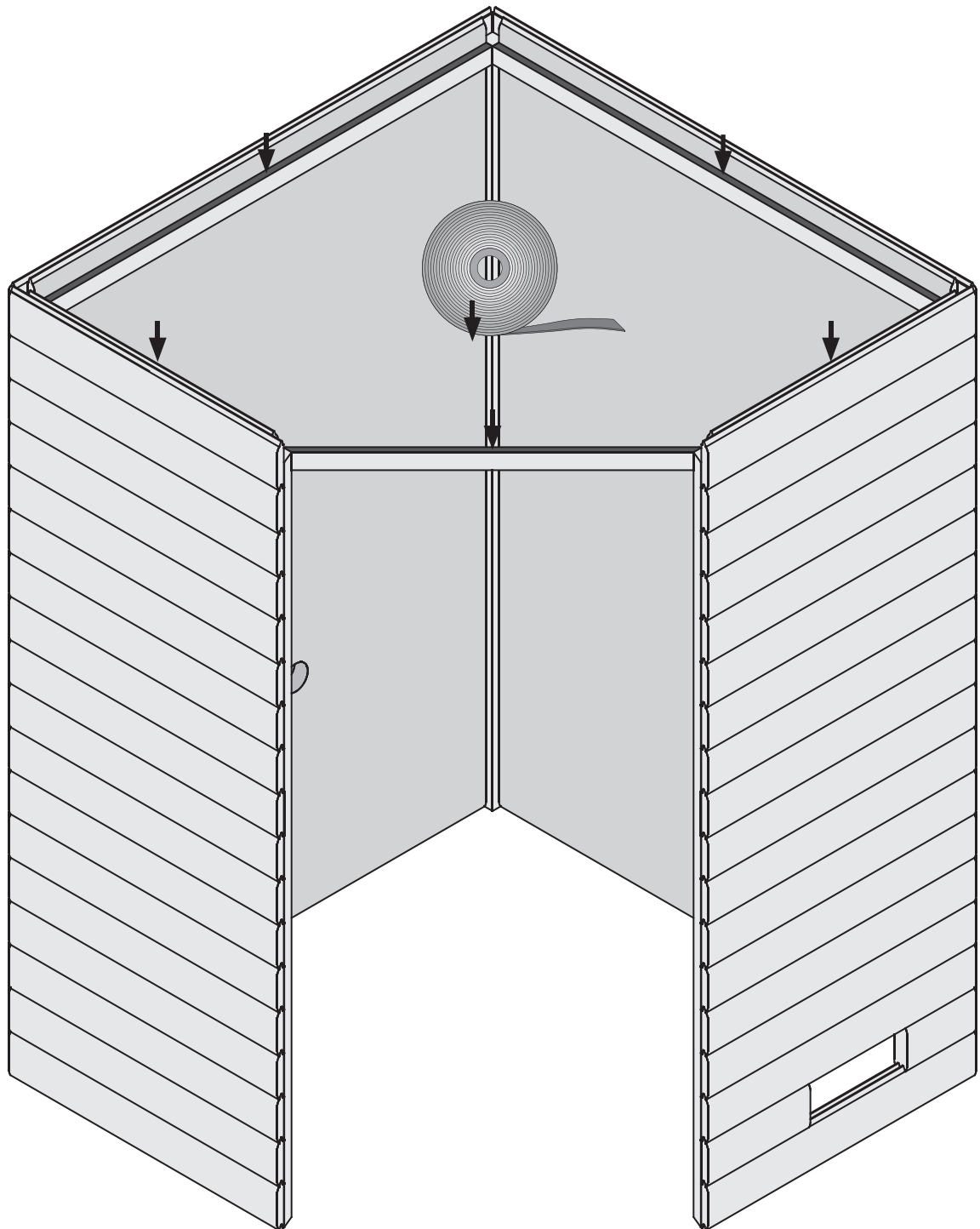
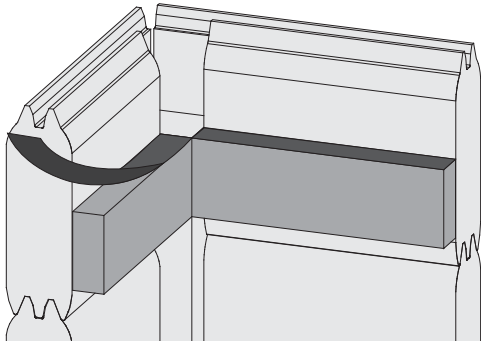

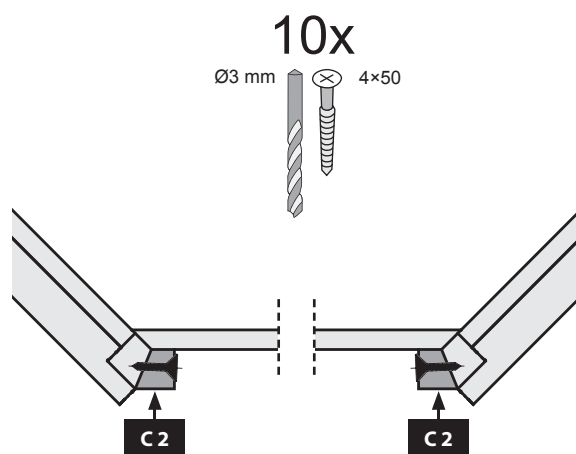
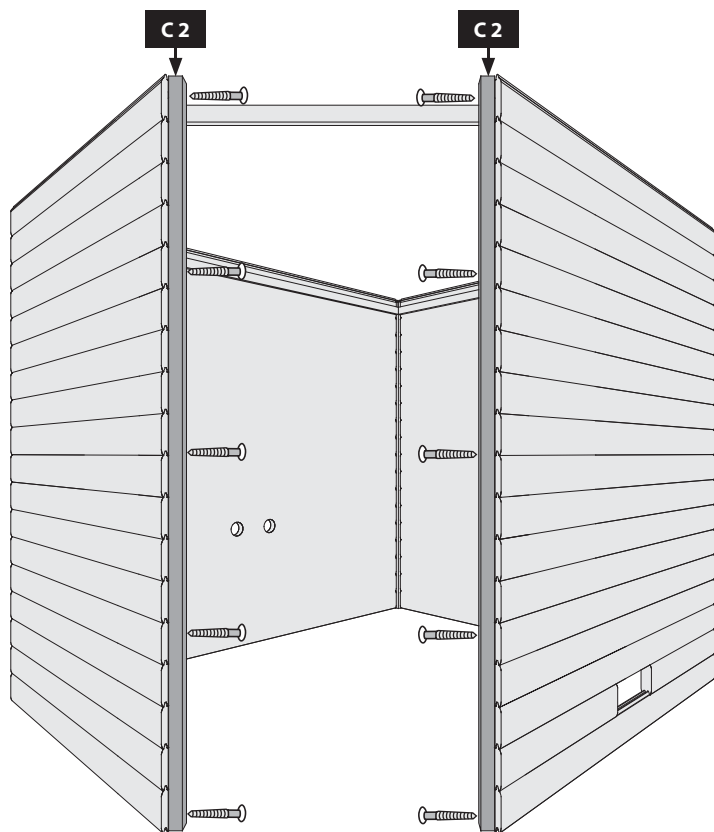
 Nastro sigillante per sauna  
 Sauna těsnící páska



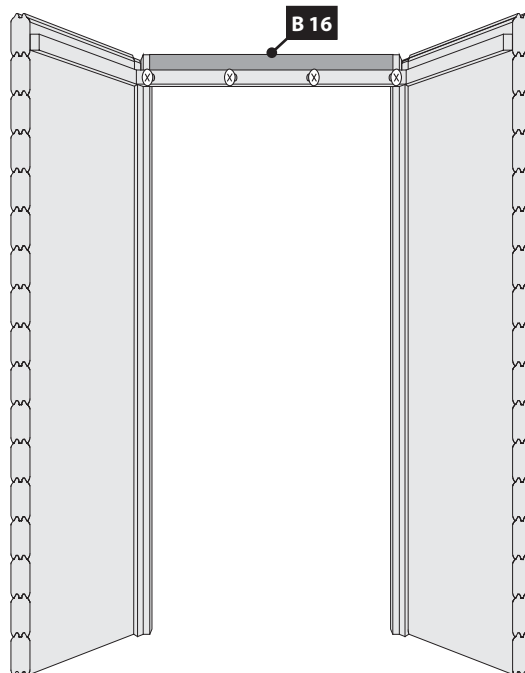
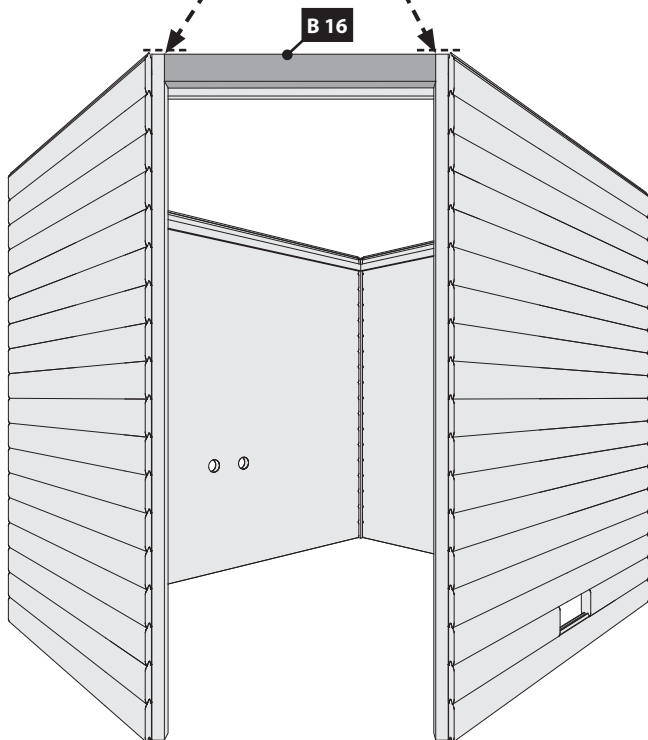
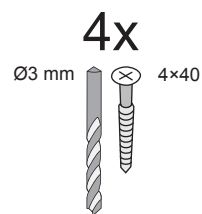
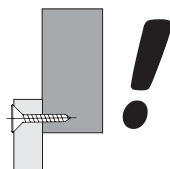





-  Bündig!
-  Flush!
-  Affleurement!
-  Gelijk!
-  I flugt!
-  Aras!
-  Combacia!
-  Stejný !



-  Einbau Glastür
-  Installation of glass door
-  Montage porte en verre
-  Montage van de glazen deur

-  Installationsglasdør
-  Montaje de la puerta de cristal
-  Installazione portello di vetro
-  Sauna Instalace dveře

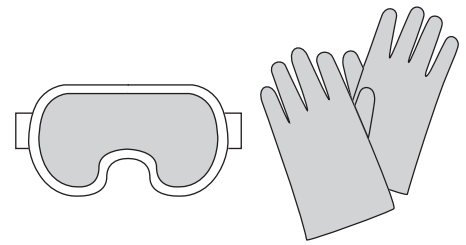

## 08

-  Saunätürglas in den Türrahmen legen
-  Put the door glass in the frame
-  Mettez le verre de la porte dans le cadre
-  Plaats het deurglas in het frame
-  Sæt dørglasset i rammen
-  Pon el vidrio de la puerta en el marco
-  Metti il vetro della porta nel telaio
-  Vložte sklo dveří do rámu

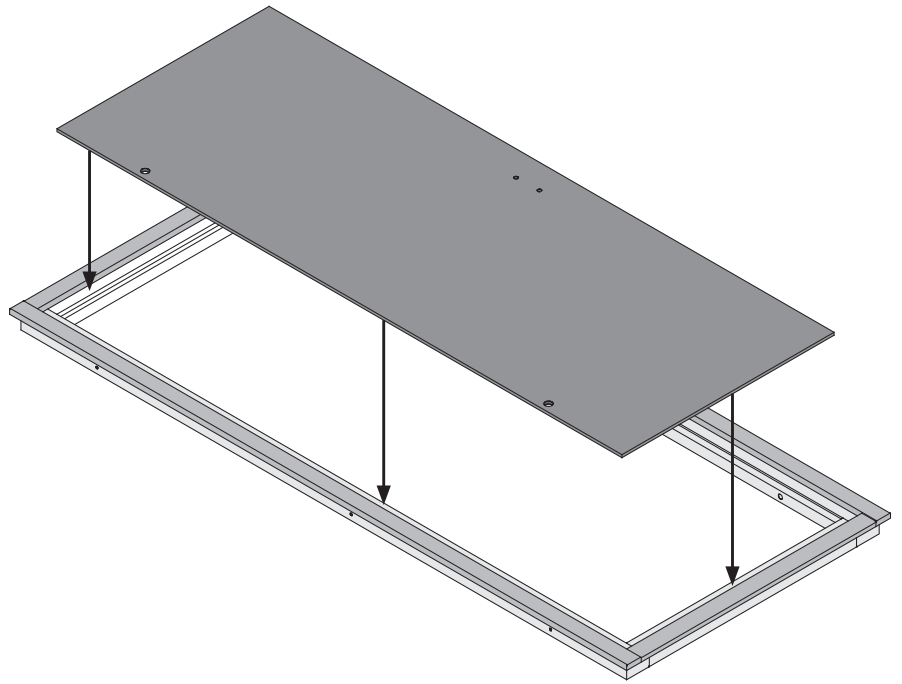

## 09

-  Saunätürglas in den Türrahmen ausrichten
-  Center the glass in the wooden frame
-  Bien aligner le verre à vitre
-  Lijn het glas uit in het deurframe
-  Juster saunaens dørglas i dørkarmen
-  Alinee el vidrio en el marco de la puerta
-  Allineare il vetro nel telaio della porta
-  Skleněná dvířka sauna v zárubně zarovnat

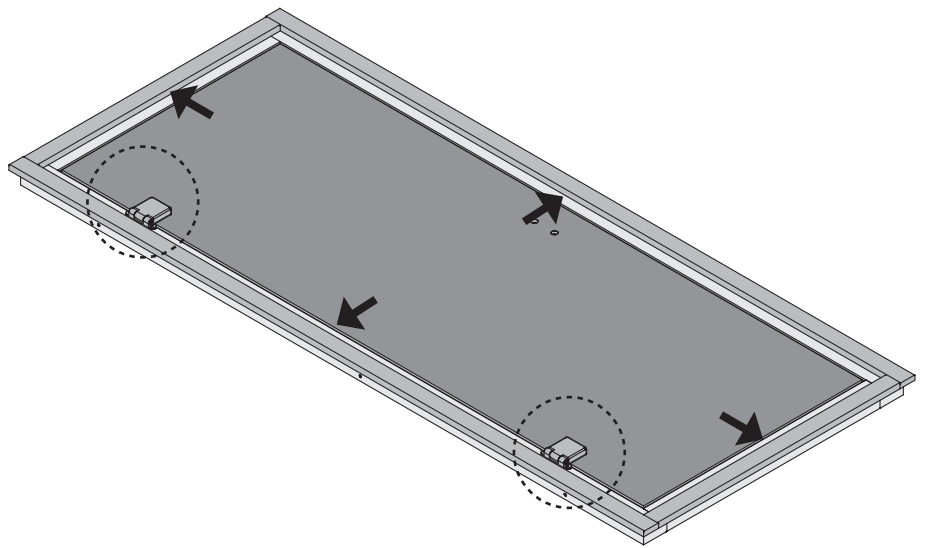

### 1.

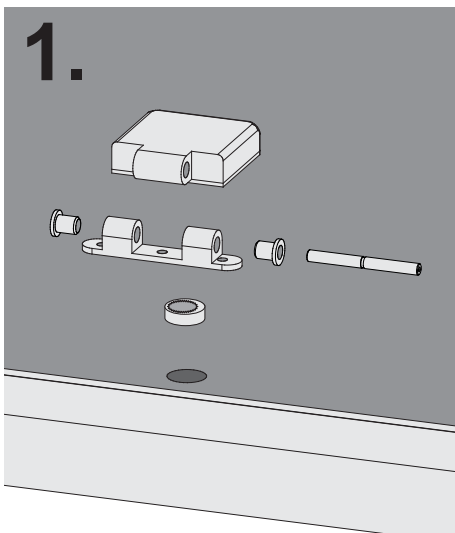

### 2.

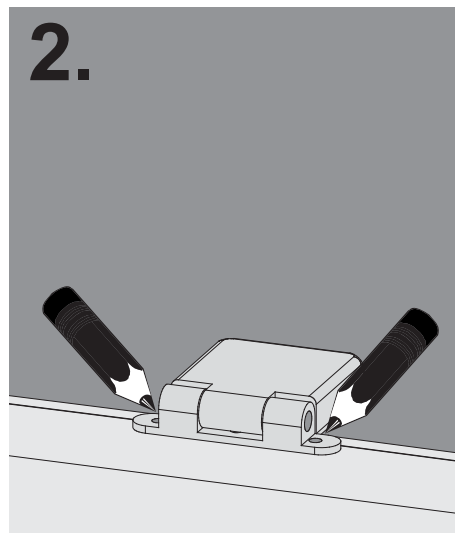

### 3.

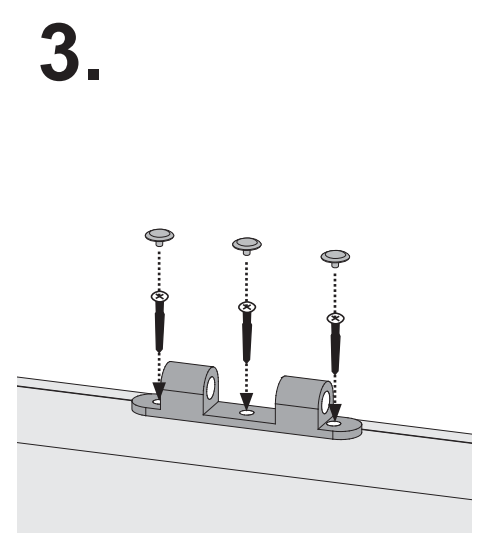

6×80

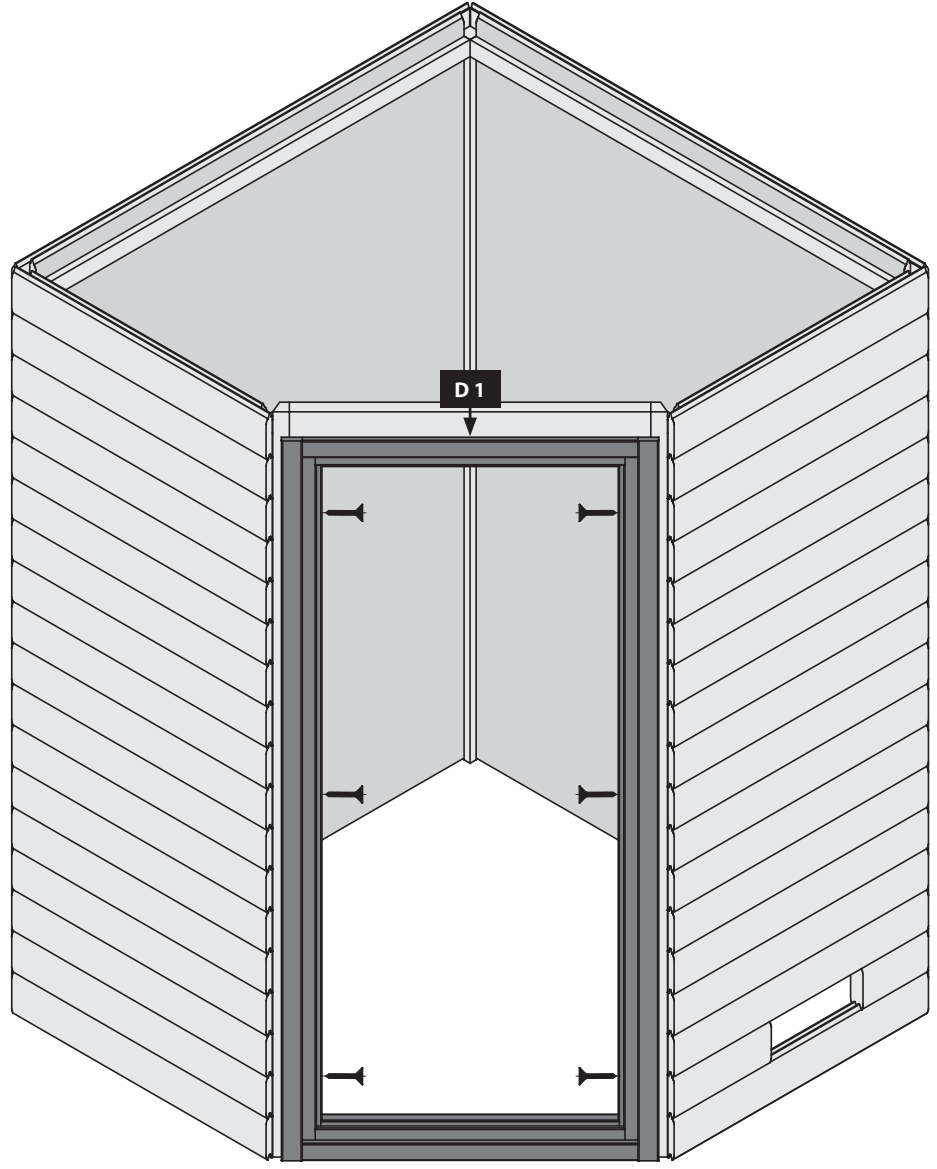
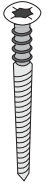
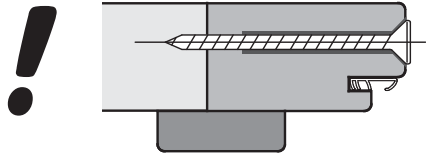

1.

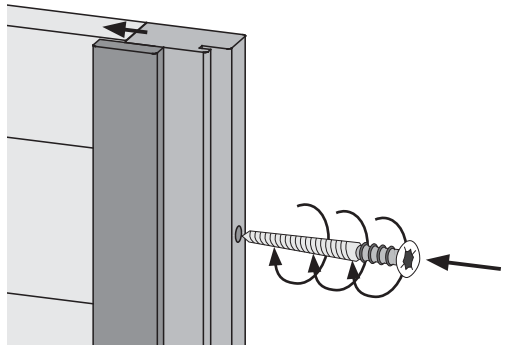

2.

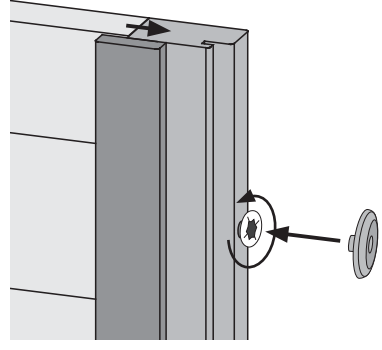

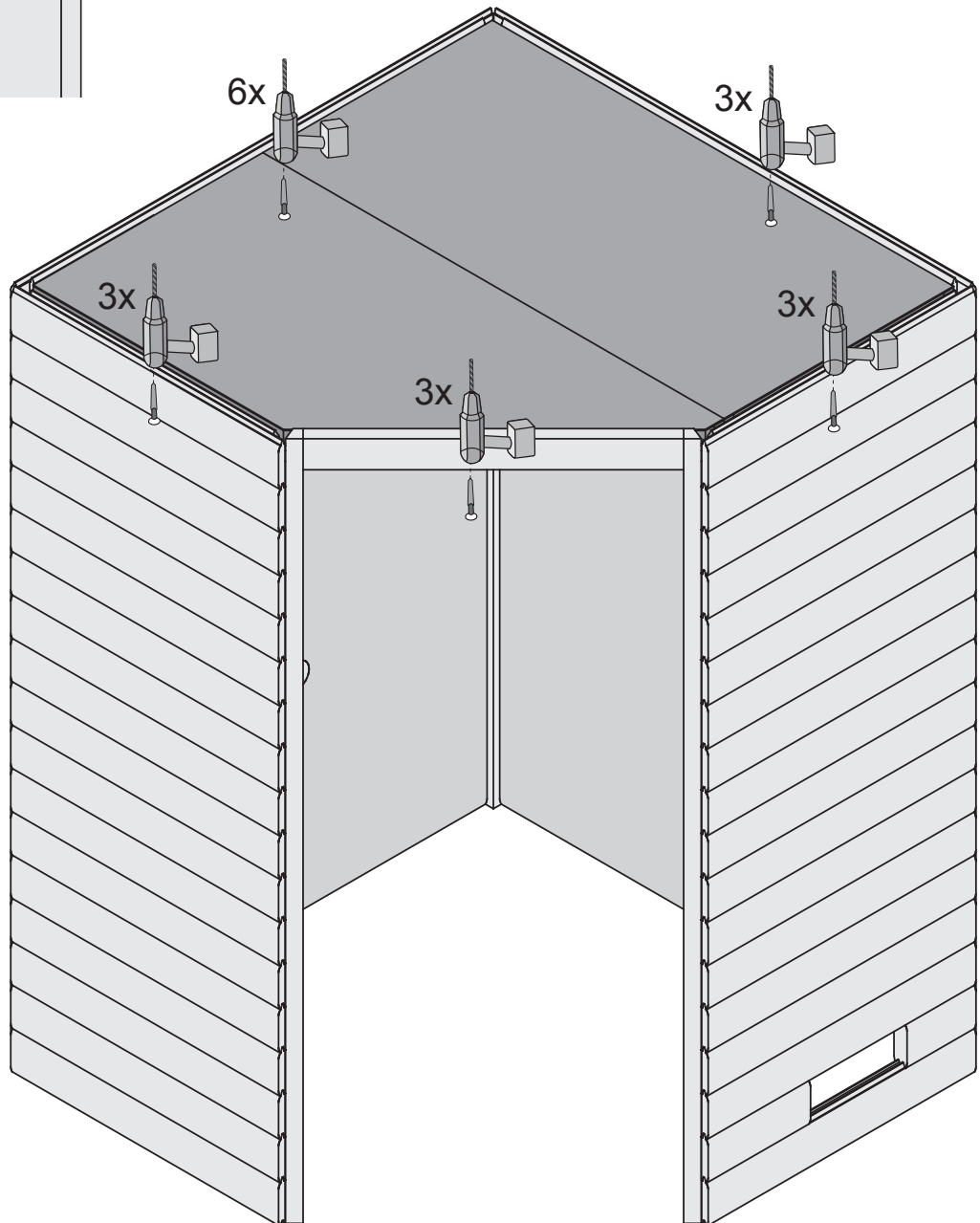
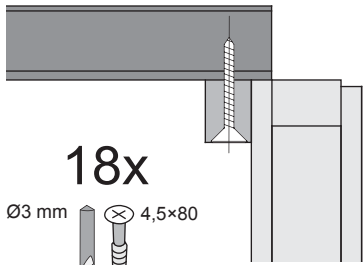
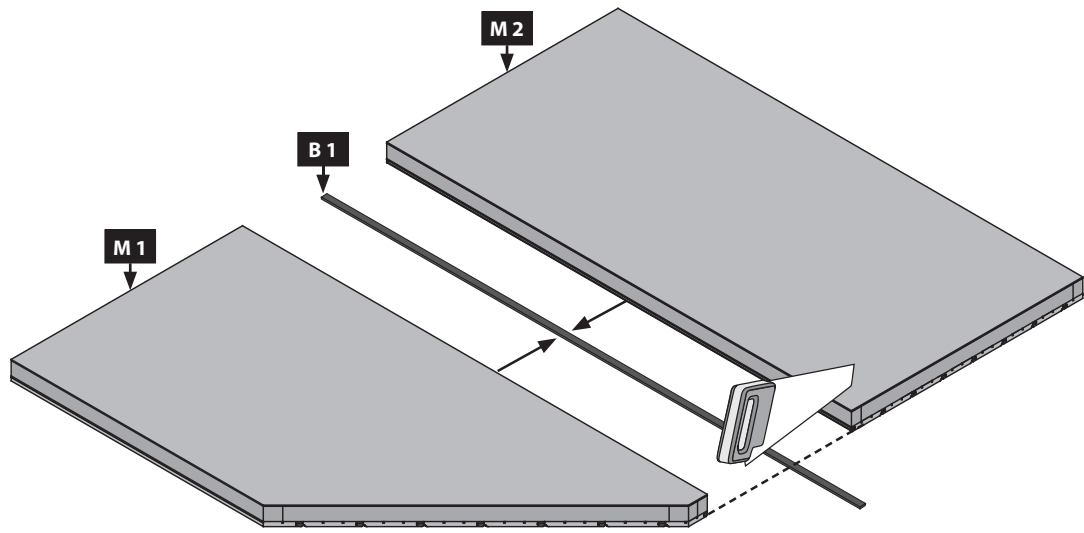

12

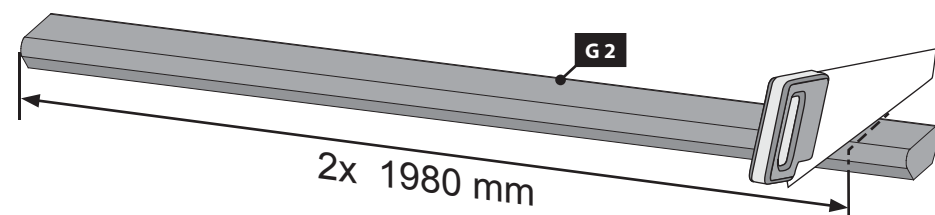
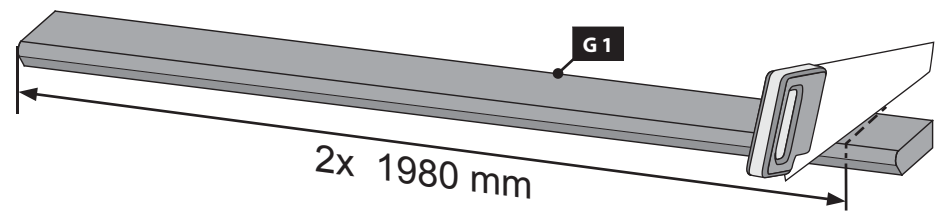
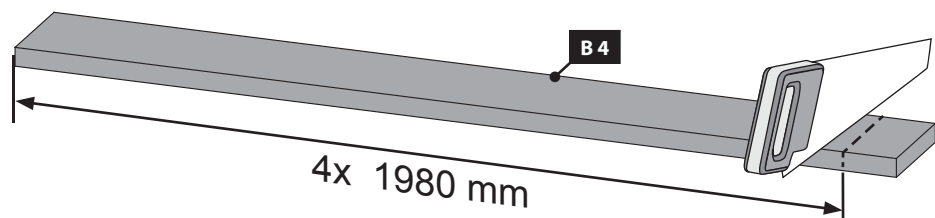

13.1

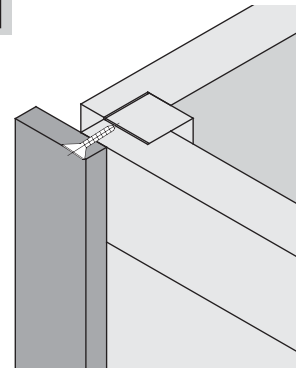

13.2

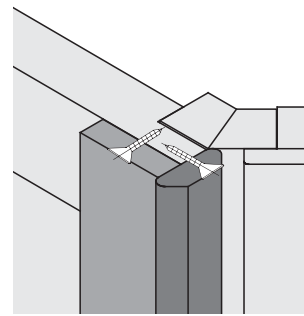

13

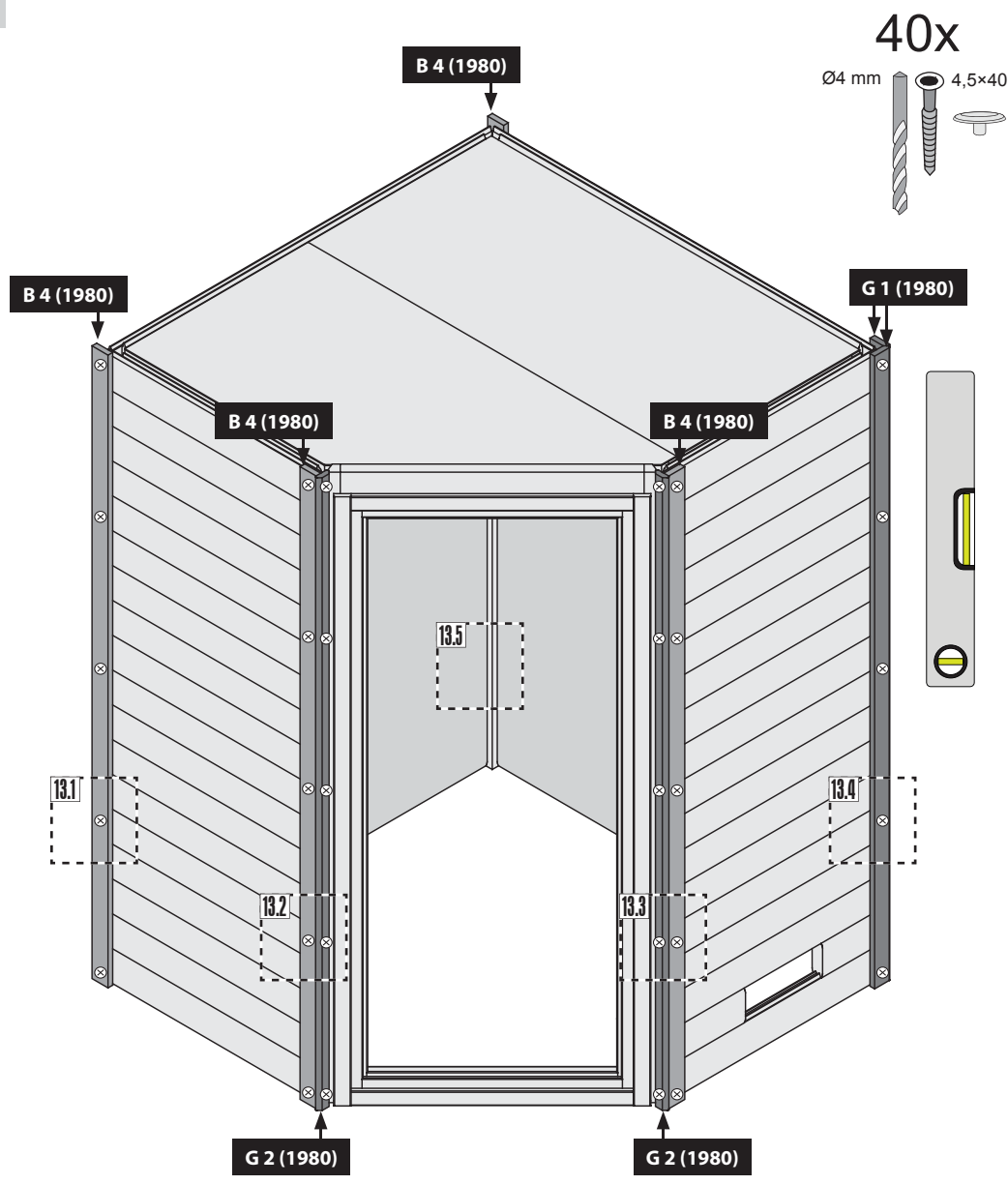

13.3

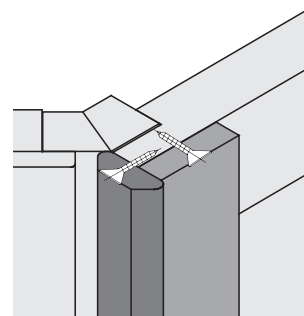

13.4

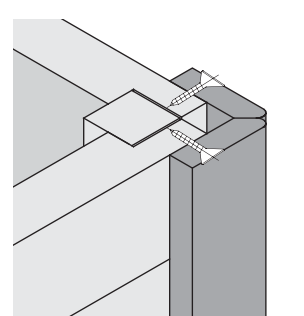

13.5

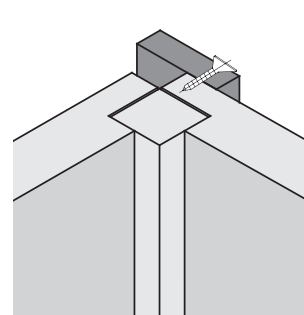

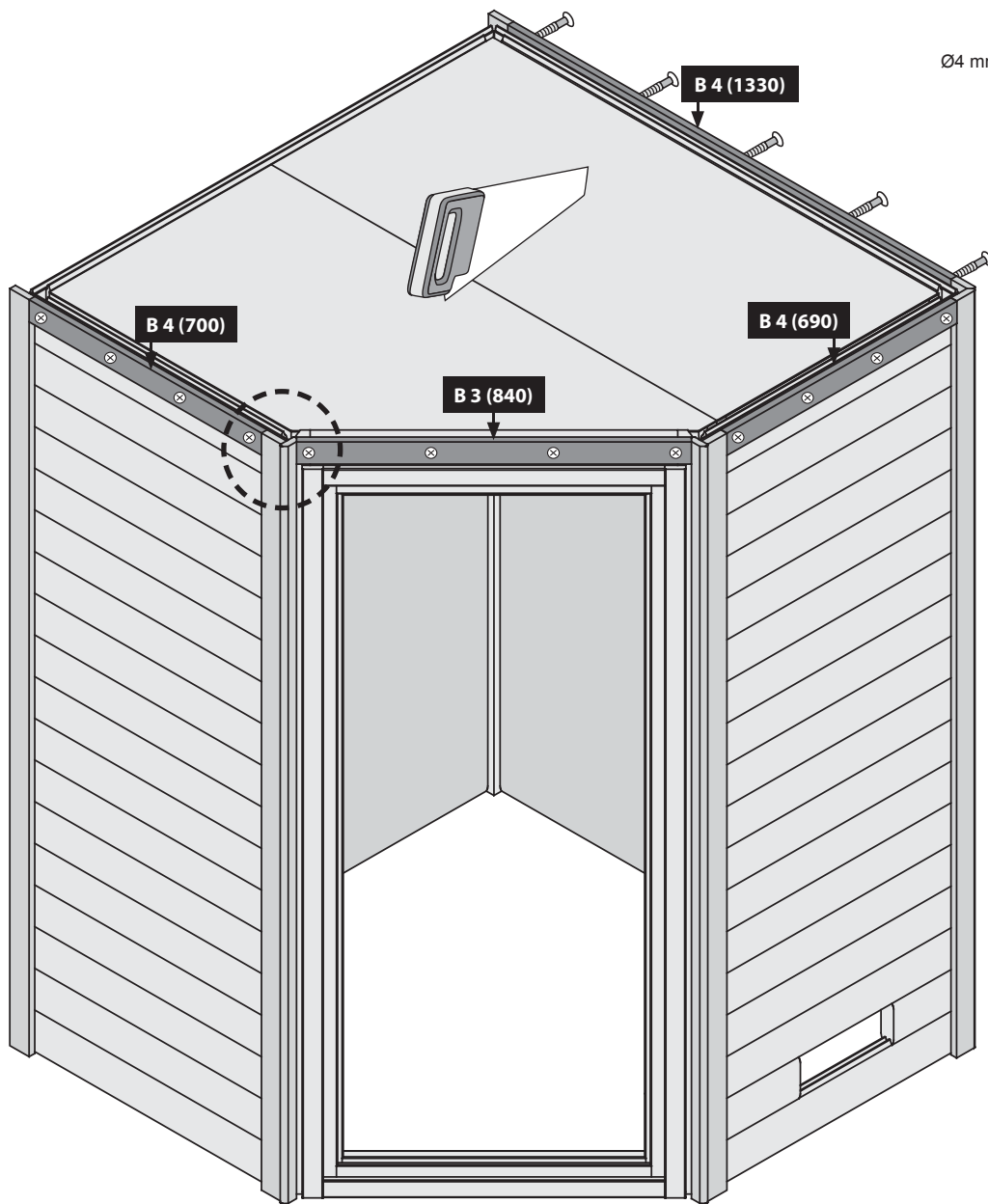

17x

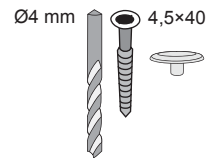



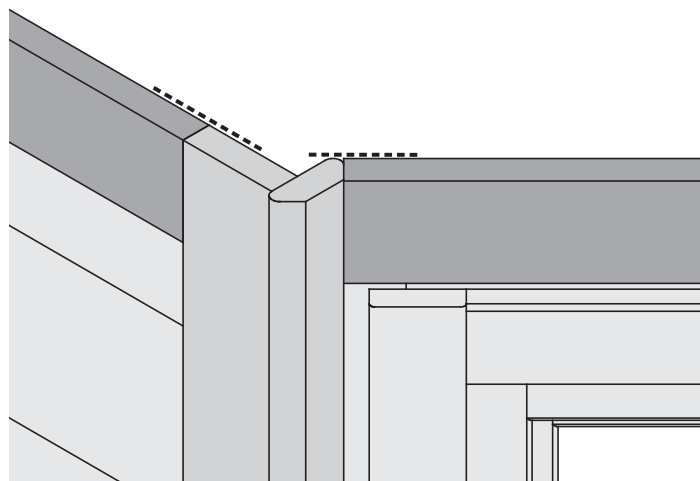



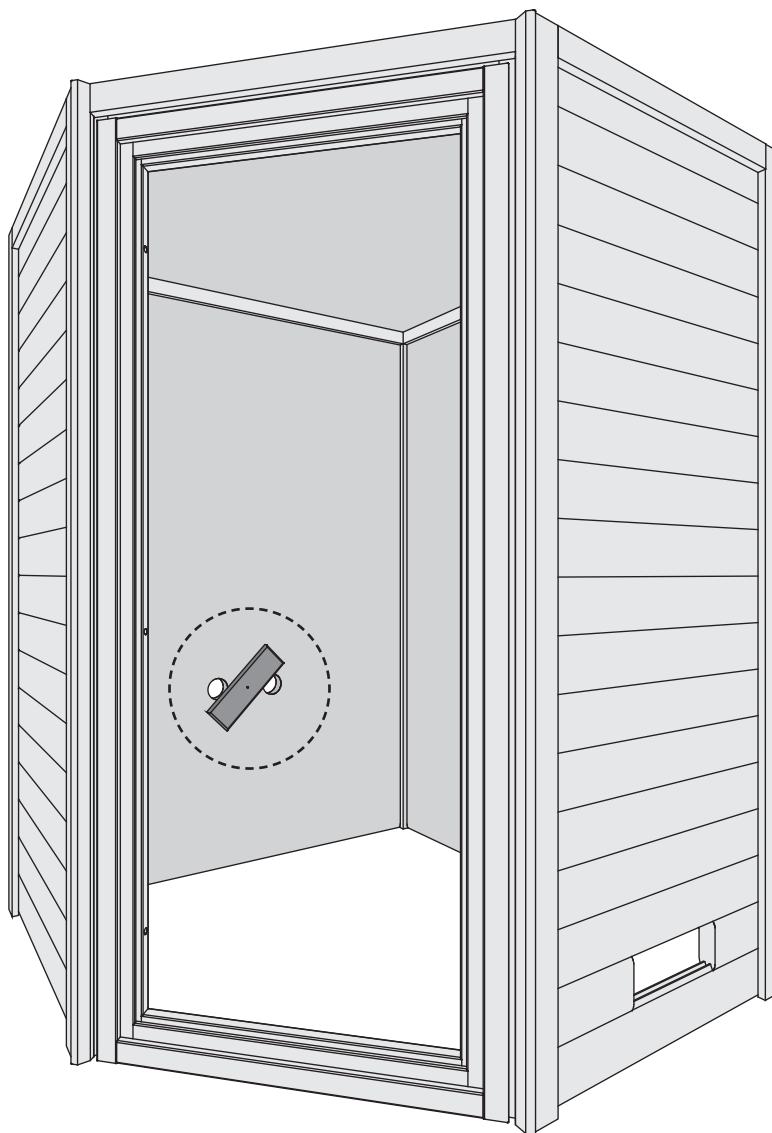
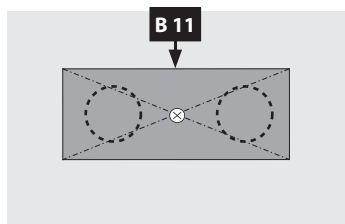
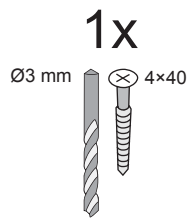

-  Bündig!
-  Flush!
-  Affleurement!
-  Gelijk!
-  I flugt!
-  Aras!
-  Combacia!
-  Stejný!







-  Hier ist die Funktionsweise des Brettes abgebildet. Regeln Sie damit die Abluft nach Ihren eigenen Wünschen
-  This figure shows the functional principle of the board. Regulate the exhaust air according to your own wishes
-  Ceci représente le mode de fonctionnement de la planche. Avec elle, réglez l'écoulement de l'air selon vos désirs
-  Hier is de werking van het plankje afgebeeld. Regel daarmee de luchtafvoer naar eigen wens
-  Sådán fungerer styret. Brug den til at regulere udstødningsluften efter dine egne ønsker
-  Aquí está representada la forma de funcionamiento de la tabla. Regule con ello el aire de salida según sus propios deseos
-  Viene illustrato il principio di funzionamento della tavoletta di regolazione della ventilazione. Con essa si può regolare a piacere la ventilazione
-  Zde je zobrazená funkce desky. Regulujte s ní odsávací vzduch dle Vašeho přání

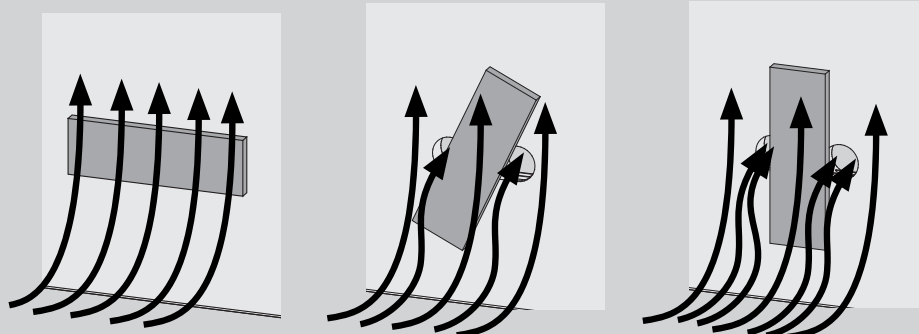

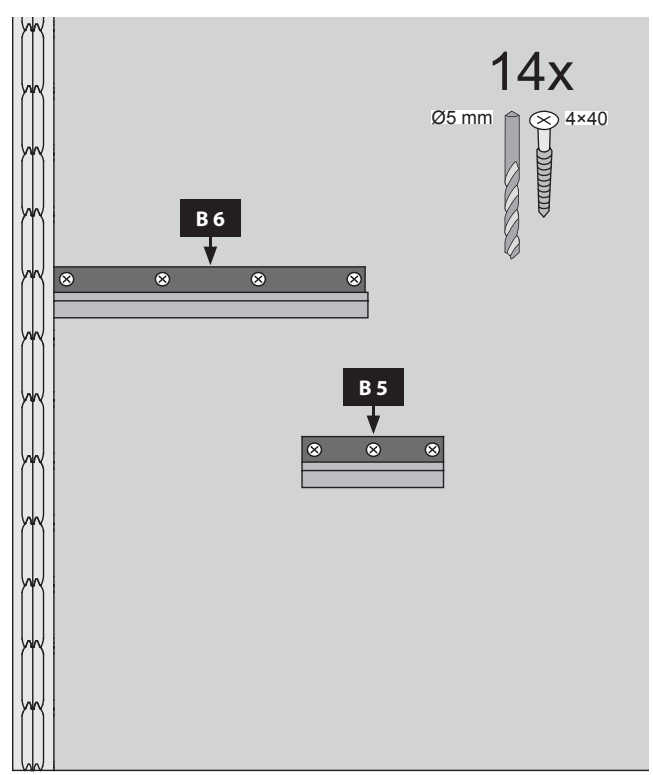
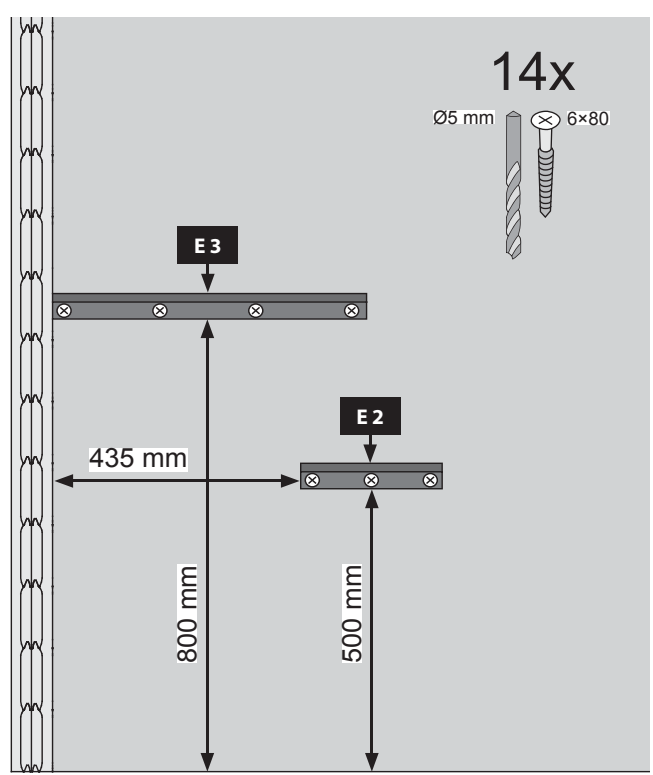
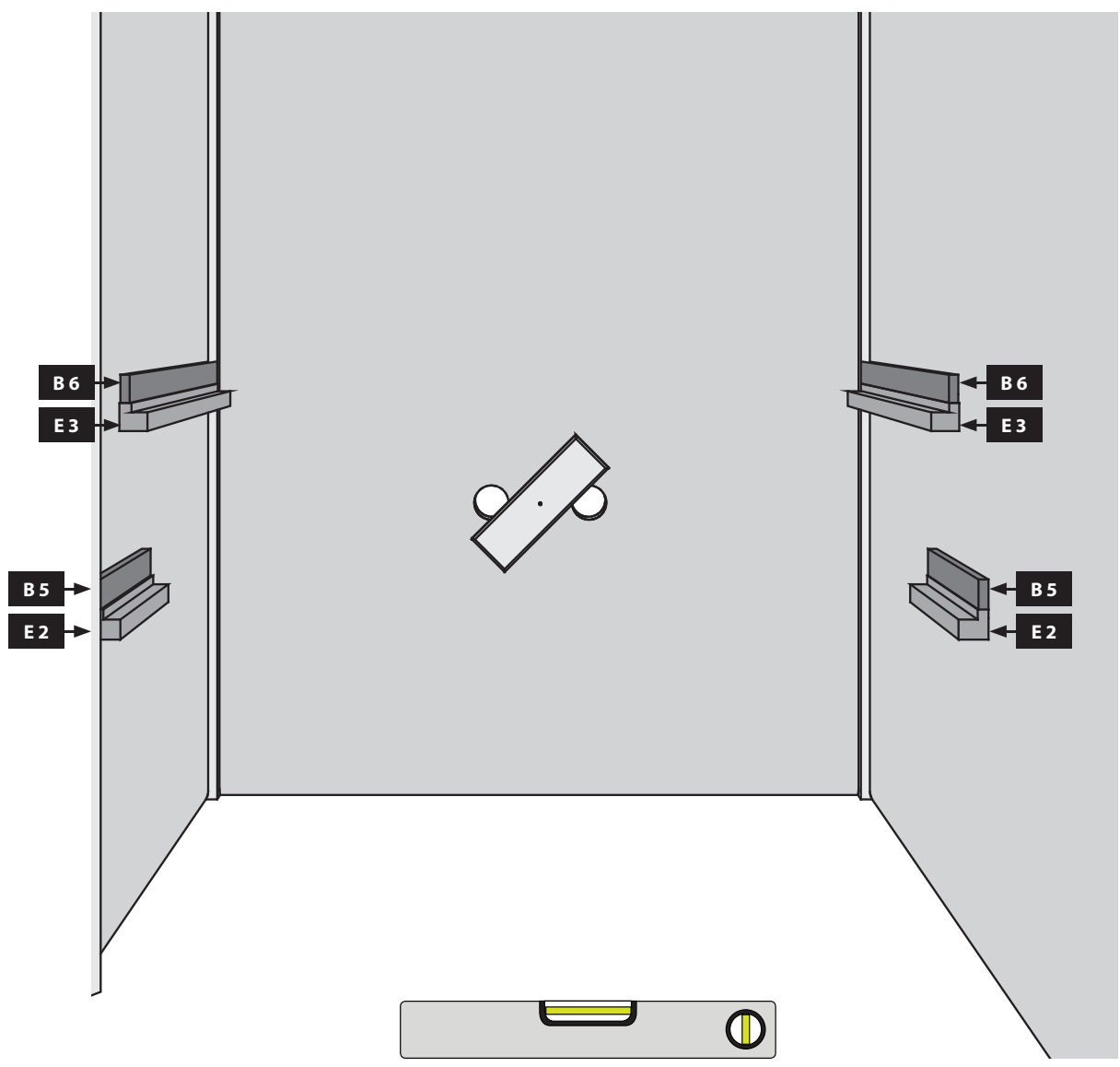

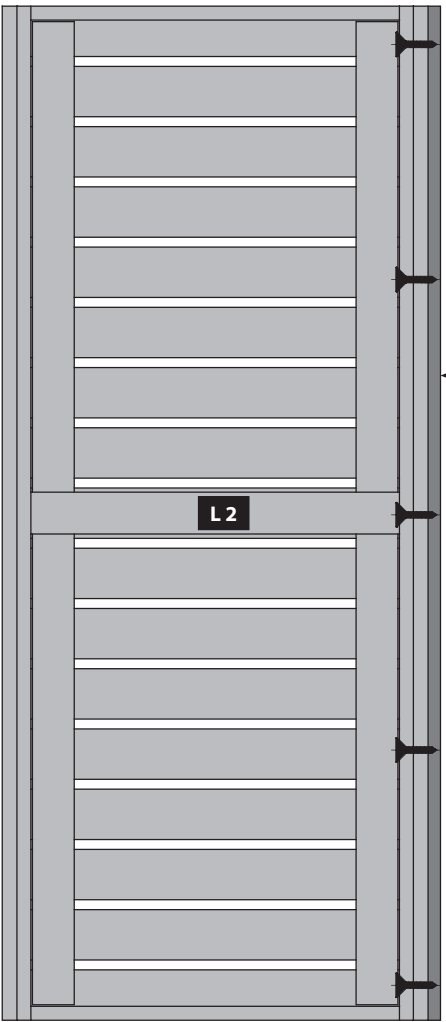

B 2

B 2

L 2

L 1

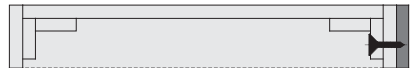

10x

Ø3mm 4x50

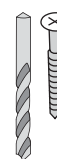

-  Ansicht unten
-  View below
-  Voir ci-dessous
-  Bekijk hieronder
-  Se nedenfor
-  Ver abajo
-  Visualizza sotto
-  Zobrazit níže

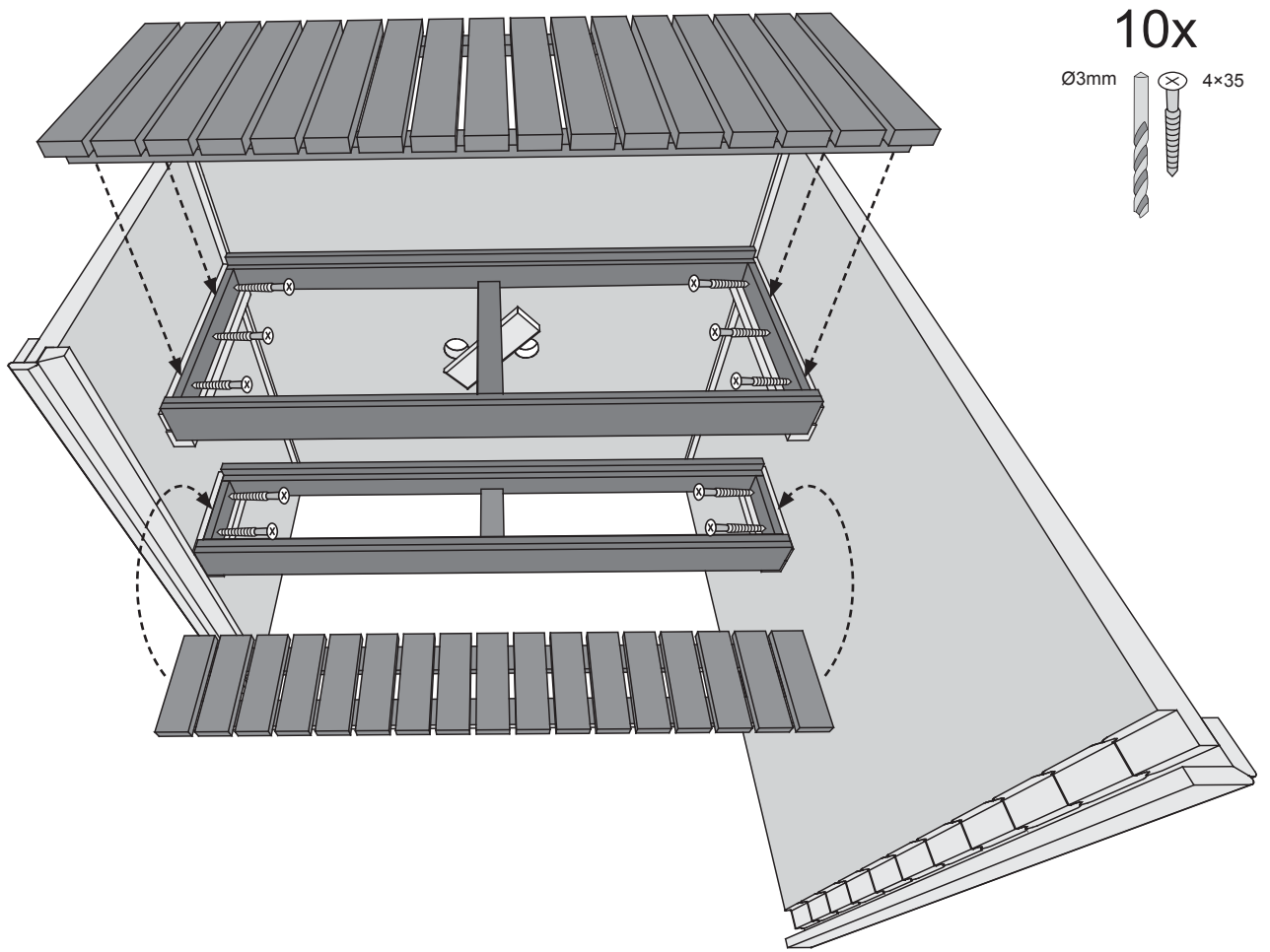

10x

Ø3mm 4x35

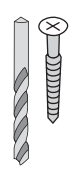

19 2x

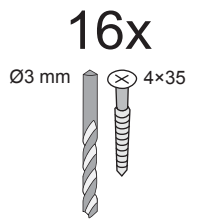
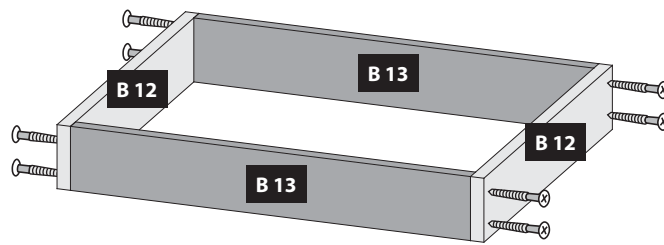

20 a

-  Nur bei 9 kW-Ofen
-  Sólo calentador de 9 kW
-  Seulement 9 kW chauffe
-  Solo riscaldamento 9 kW
-  Only 9 kW heater
-  Pouze topné těleso 9 kW
-  Slechts 9 kW heater

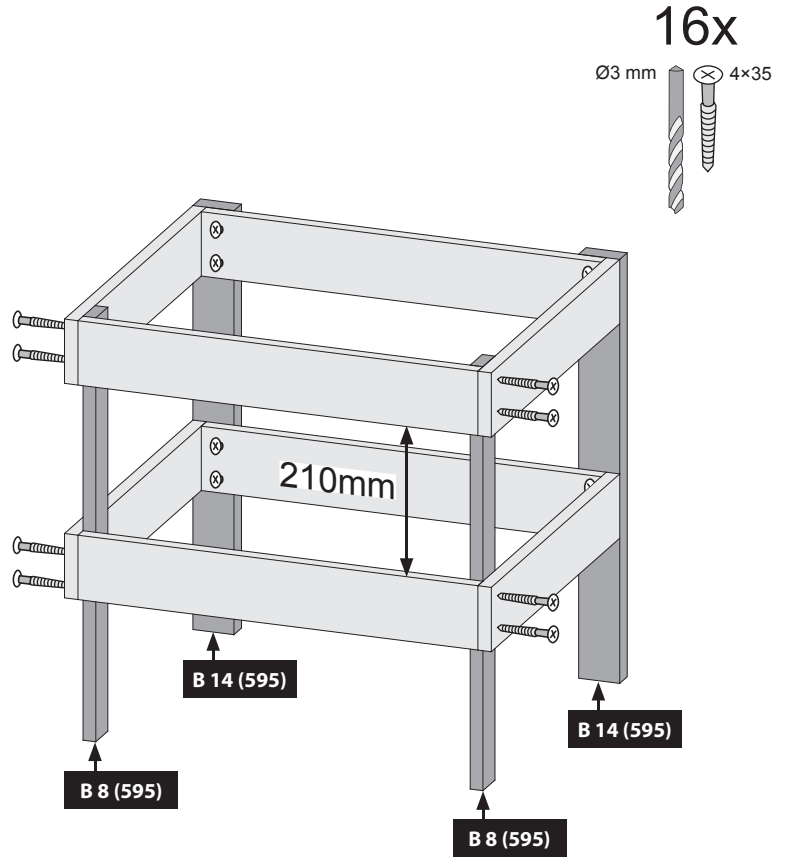
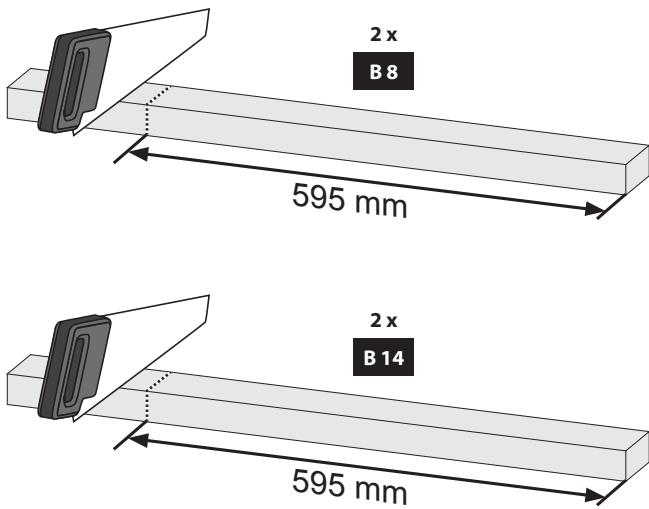

20 b

-  Bei allen anderen Öfen
-  Para todos los otros hornos
-  Pour tous les autres fours
-  Per tutti gli altri tipi di forni
-  For all other furnaces
-  U všech ostatních pecích
-  Voor alle andere ovens

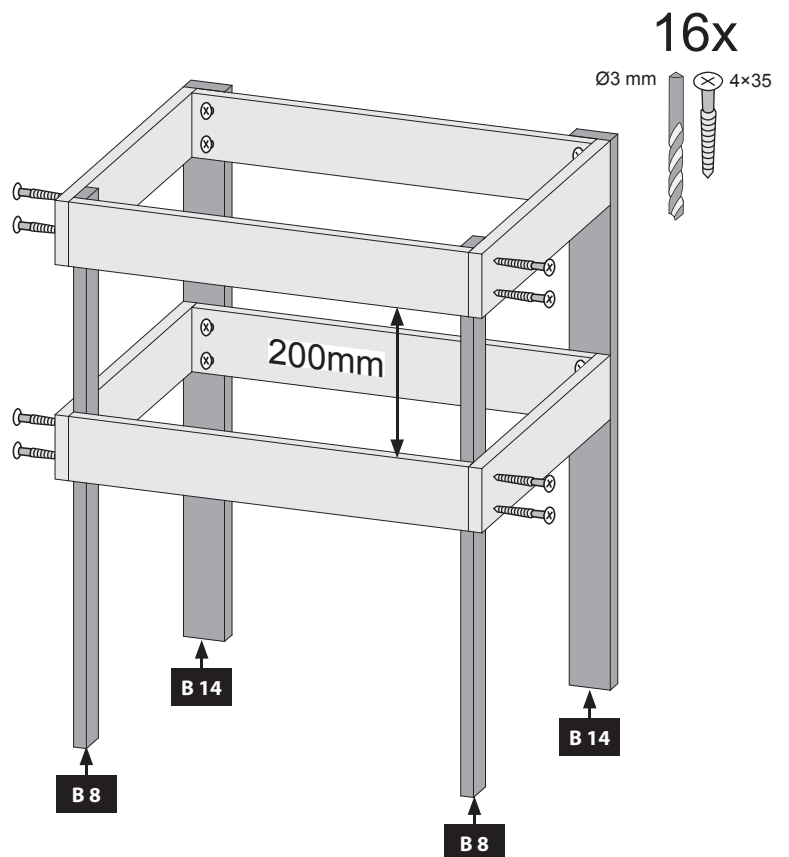





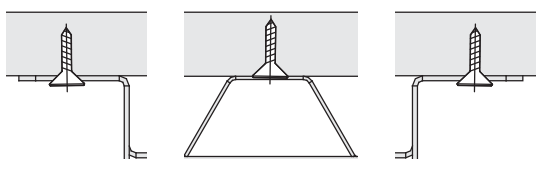
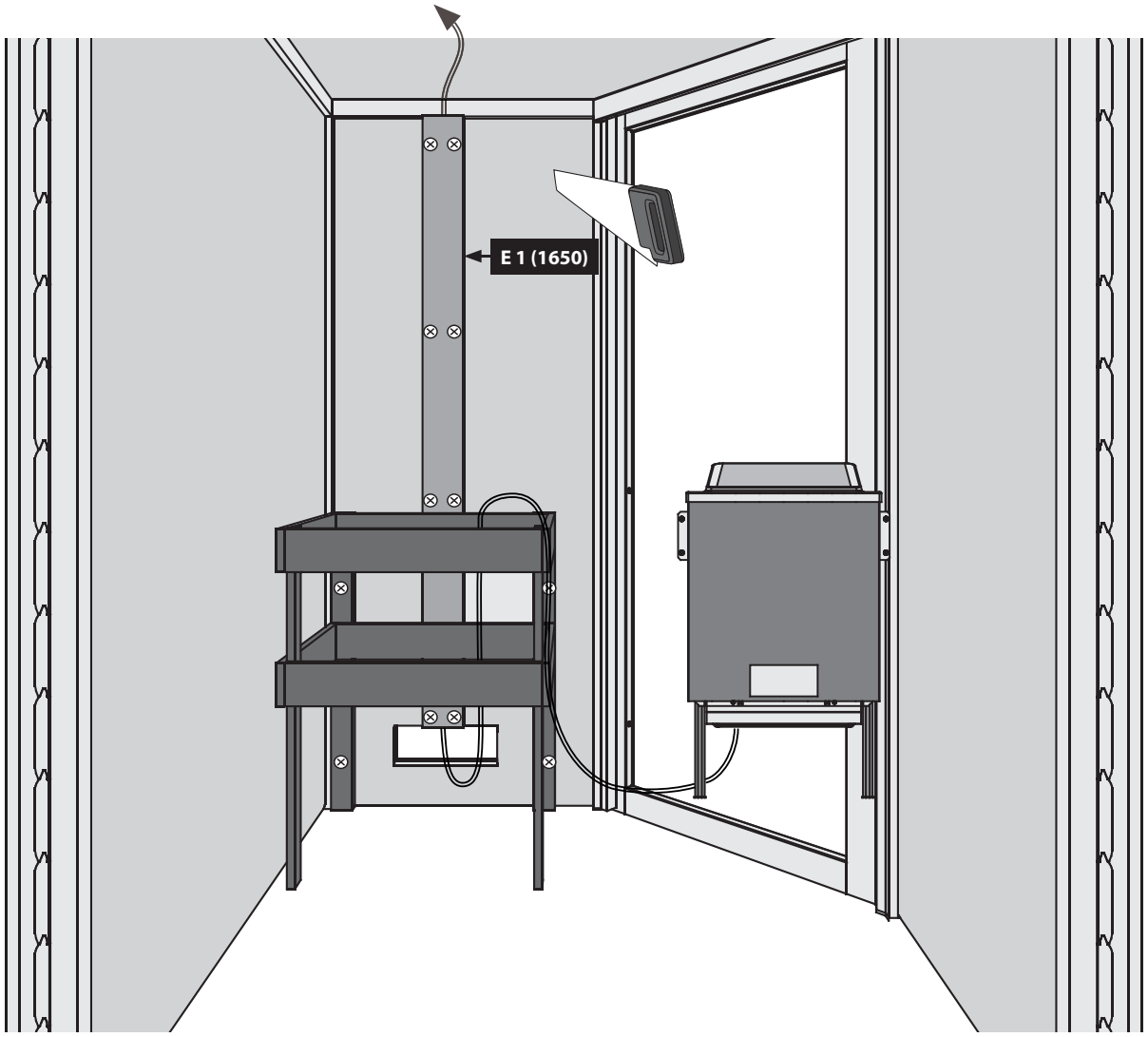



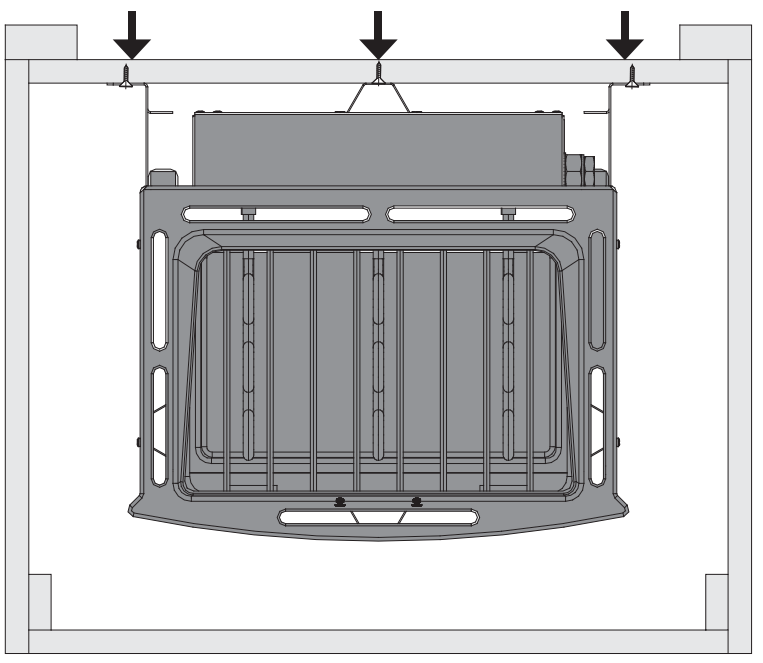

Ø3mm  
12x  
4x40



-  Ofenbefestigung
-  oven fixing
-  fixation four
-  oven vaststelling
-  ovn fastsættelse
-  fijación horno
-  fissaggio forno
-  upevňovací trouba



-  Einbau Glastür
-  Installation of glass door
-  Montage porte en verre
-  Montage van de glazen deur

-  Installationsglasdør
-  Montaje de la puerta de cristal
-  Installazione portello di vetro
-  Sauna Instalace dveře

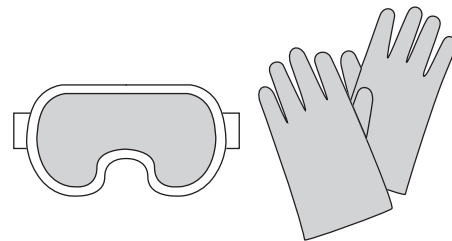

23

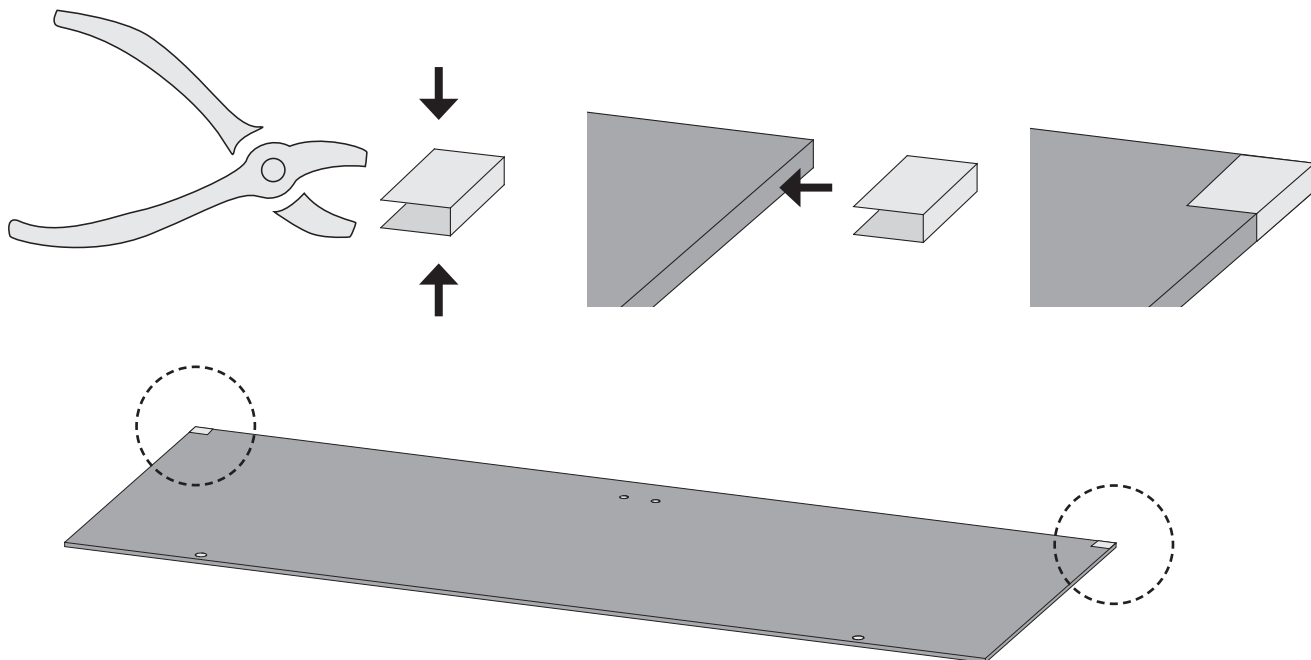



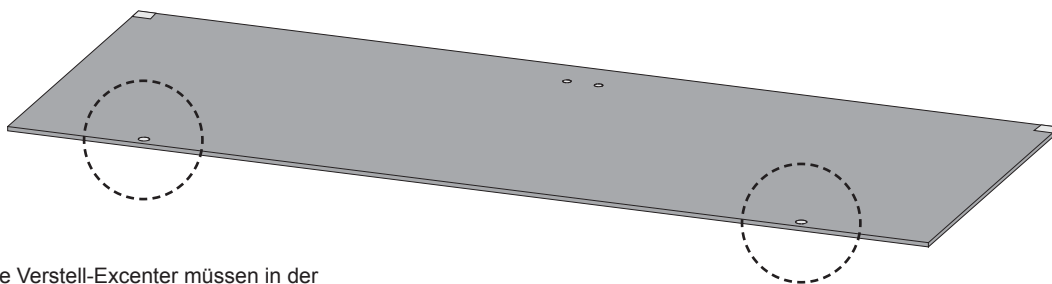



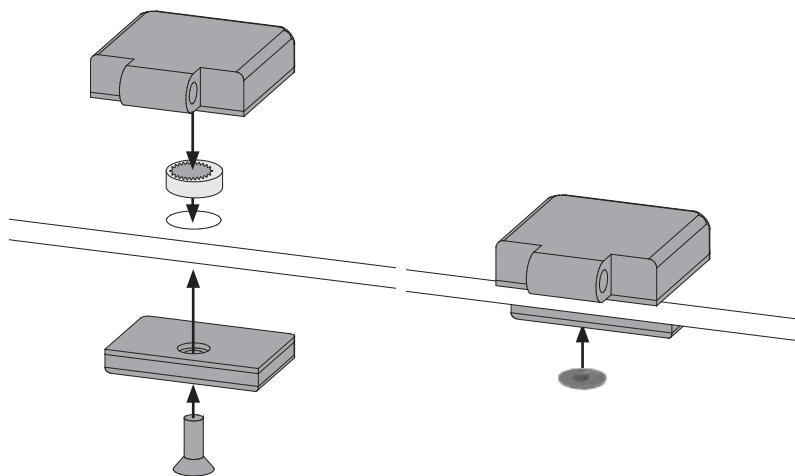

24







-  Alle Verstell-Excenter müssen in der Glasscheibe die gleiche Grundstellung haben
-  All adjustable eccentrics must have the same basic adjustment in the glass panel
-  Tous les excenteurs de positionnement doivent avoir la même position de base dans la vitre
-  Alle excentrische verstelelementen moeten in dezelfde stand in de glasplaat worden geplaatst
-  Alle justeringsexcenter skal have samme grundlæggende position i glasruden
-  Todos los excéntricos regulables tienen que tener la misma posición base en la hoja de cristal
-  Tutti gli eccentrici di regolazione devono avere la stessa posizione base nella lastra di vetro
-  šechny nastavovací podivínů musí mít stejný základní polohy ve skle



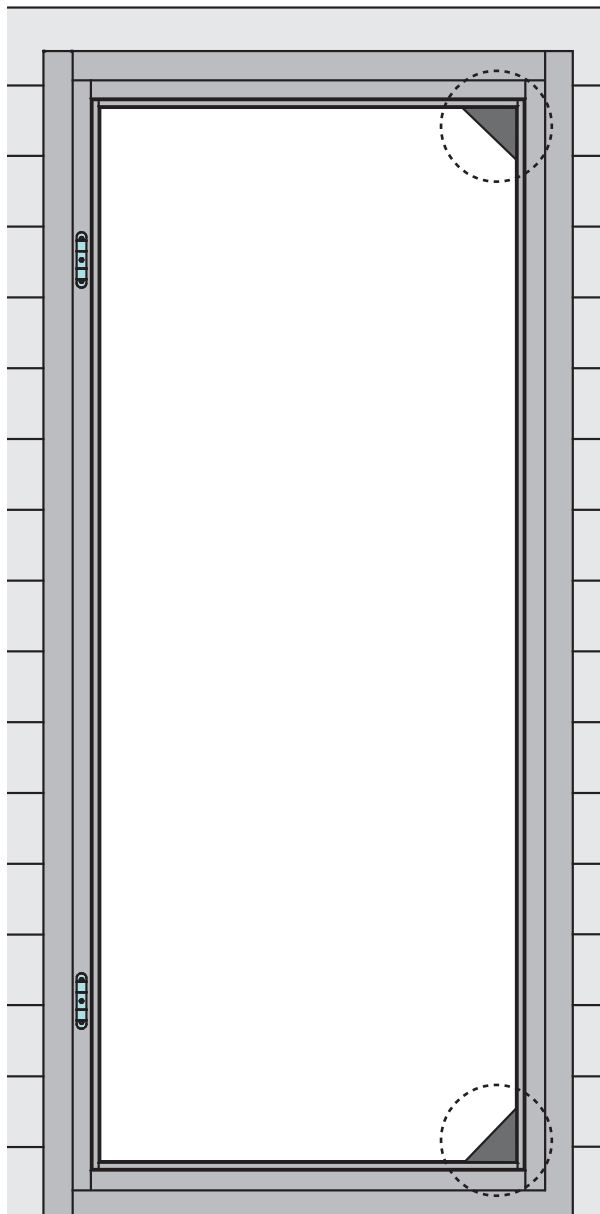
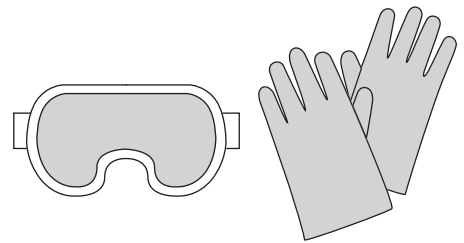



-  Einbau Glastür
-  Installation of glass door
-  Montage porte en verre
-  Montage van de glazen deur





-  Installationsglasdør
-  Montaje de la puerta de cristal
-  Installazione portello di vetro
-  Sauna Instalace dveře



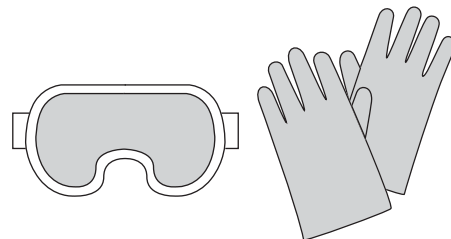



-  Einbau Glastür
-  Installation of glass door
-  Montage porte en verre
-  Montage van de glazen deur

-  Installationsglasdør
-  Montaje de la puerta de cristal
-  Installazione portello di vetro
-  Sauna Instalace dveře



-  Alle Verstell-Excenter müssen in der Glasscheibe die gleiche Grundstellung haben
-  All adjustable eccentrics must have the same basic adjustment in the glass panel
-  Tous les excentreurs de positionnement doivent avoir la même position de base dans la vitre
-  Alle excentrische verstelelementen moeten in dezelfde stand in de glasplaat worden geplaatst

-  Alle justeringsexcentricer skal have samme grundlæggende position i glasruden
-  Todos los excéntricos regulables tienen que tener la misma posición base en la hoja de cristal
-  Tutti gli eccentrici di regolazione devono avere la stessa posizione base nella lastra di vetro
-  Šechny nastavovací podivínů musí mít stejný základní polohy ve skle

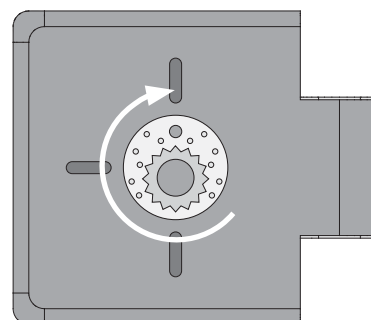
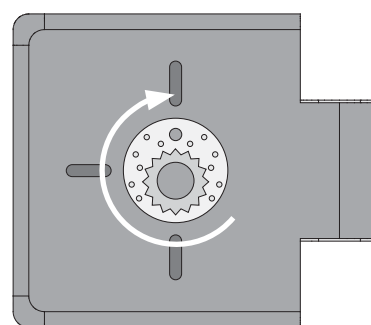
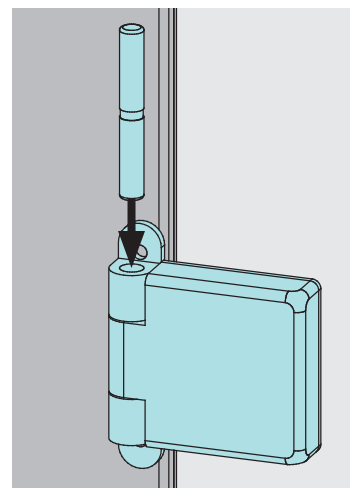
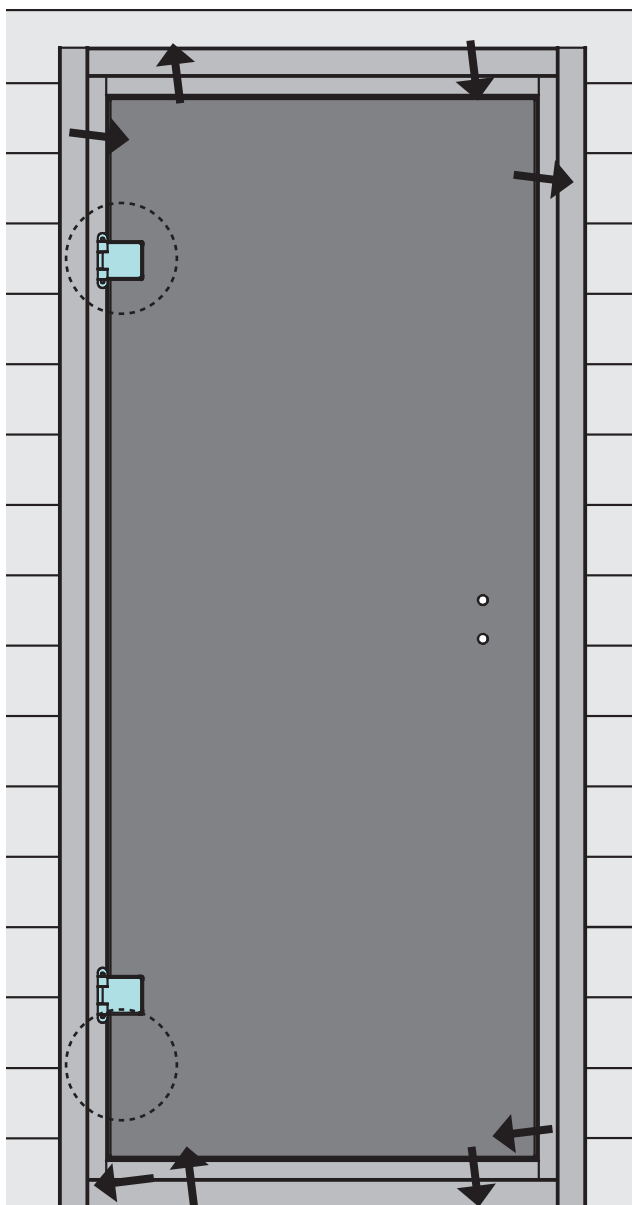



1.

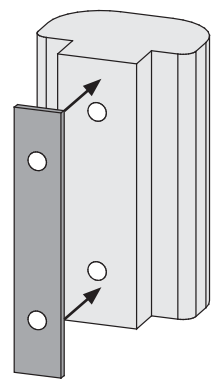

2.

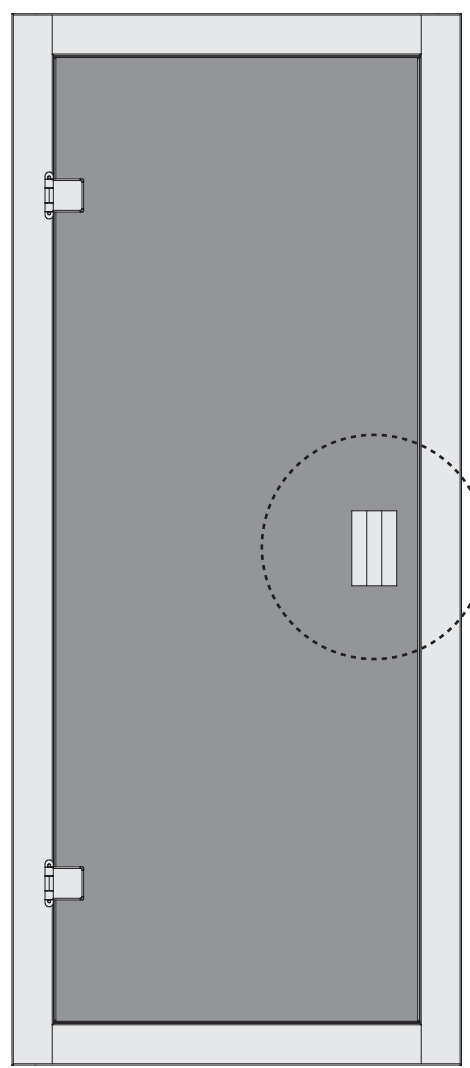
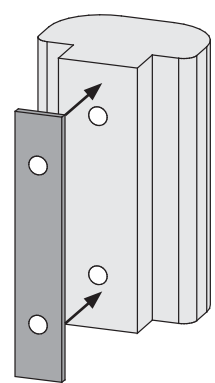

3.

