

26251 85828-2012



 **Aufbauanleitung**

 **Instrucciones de construcción**

 **notice de montage**







 **Istruzioni per il montaggio**





 **Building Instructions**





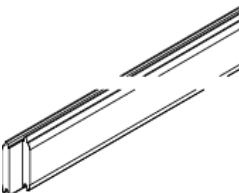

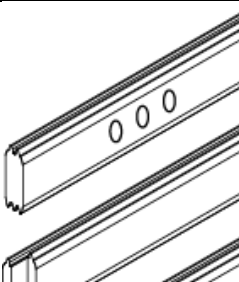
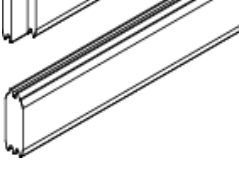

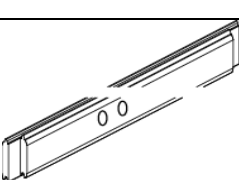

 **montagehandleiding**







 **Navodila za montažo**

 **Service-Hotline: +49 421 38693 33**

						
Vergleichen Sie zuerst die Materialliste mit Ihrem Paketinhalt! Bitte haben Sie Verständnis, dass Beanstandungen nur im <u>nicht aufgebauten</u> Zustand bearbeitet werden können!	Vergelijk eerst de lijst van materialen met de inhoud van uw pakket! Reclamaties kunnen alleen in behandeling worden genomen zodanig de onderdelen <u>nog niet zijn gemonteerd!</u>	Veuillez d'abord comparer la liste du matériel avec le contenu de votre colis! Nous vous remercions de bien vouloir comprendre que les réclamations ne peuvent être traitées qu'à l'état <u>non monté</u> !	En primer lugar, compare la lista de material con el contenido del paquete. Rogamos entienda que las reclamaciones sólo pueden ser tramitadas <u>antes</u> montar el objeto.	Firstly compare the material list with the contents of your package! Please appreciate that complaints can be processed only in the <u>non-assembled state!</u>	Confrontare la distinta dei materiali con il contenuto del pacchetto! Le reclazioni potranno essere accettate solamente se i prodotti <u>non sono ancora stati montati!</u>	Najprej preglejte seznam materiala v vašem paketu! Upoštevajte, da se lahko pritožite le, dokler deli še niso sestavljeni.

Art.Nr. Art.-nr. Art. N°: N° Art. Art. no. Art.N°: Št. art.:	Nr Nr. N° No N°. Št.	Bezeichnung Benaming Désignation Denominación Description Descrizione Opis	Bild Afbeelding Illustration Dibujo Illustration Immagine Slika	Länge Lengte Longueur Long. Length Lungh. Dolžina	Breite Breedte Largeur Ancho Width Largh. Širina	Stärke Dikte Épaisseur Espesor Thick-ness Spess. Debelina	Material Materiaal Matériau Material Material Materiale Material	Stück Aantal Pièce Ctdad. Number Q.tà Kos
21429	A	Wandbohle Rückwand Wandplank achterwand Madrier mural mur arrière Tablón pared posterior Wall board rear wall Asse parete posteriore Stenska deska - zadnja stena		1881	121	38	Bohle Plank Madrier Tablón Board Asse Deska	18
26573	B	Wandbohle Seite Wandplank zijkant Madrier mural côté Tablón pared lateral Wall board side Asse parete laterale Stenska deska - stranska stena		1380	121	38	Bohle Plank Madrier Tablón Board Asse Deska	36
26735	D	Wandbohle Front links Zuluft Wandplank front links luchttoevoer Madrier mural façade gauche, aération Tablón pared delantera izquierda entrada de aire Wall board front left air intake Asse parete anteriore sinistra con areazione Stenska deska spredaj levo - dovajanje zraka		545	121	38	Bohle Plank Madrier Tablón Board Asse Deska	1
21868	E	Wandbohle Front rechts Wandplank front rechts Madrier mural façade droite Tablón pared delantera derecha Wall board front right Asse parete frontale destra Stenska deska spredaj desno		545	121	38	Bohle Plank Madrier Tablón Board Asse Deska	17
21876	F	Wandbohle Front links Wandplank front links Madrier mural façade gauche Tablón pared delantera izquierda Wall board front left Asse parete frontale sinistra Stenska deska spredaj levo		545	121	38	Bohle Plank Madrier Tablón Board Asse Deska	16
21864	G	Wandbohle Abluft Wandplank luftafvoer Madrier mural évacuation de l'air Tablón pared salida de aire Wall board exhaust air Asse parete aerazione Stenska deska - odvajanje zraka		1881	121	38	Bohle Plank Madrier Tablón Board Asse Deska	1

Art.Nr. Art.-nr. Art. N°: N° Art. Art. no. Art.N°: Št. art.:	Nr Nr. N° N° No N°. Št.	Bezeichnung Benaming Désignation Denominación Description Descrizione Opis	Bild Afbeelding Dibujo Illustration Immagine Slika	Länge Lengte Longueur Long. Length Lungh. Dolžina	Breite Breedte Largeur Ancho Width Largh. Širina	Stärke Dikte Épaisseur Espesor Thick-ness Spess. Debelina	Material Materiaal Matériau Material Material Materiale Material	Stück Aantal Pièce Ctdad. Number Q.tà Kos
21431	H	Aufrechte Rahmen Hoekstijlen Cadres verticaux Marco vertical Upright frame Cornice verticale Pokončni okvir		1916	36	36	Rahmen Raamwerk Cadre Marco Frame Telaio Okvir	4
18106	I	Leiste Tür innen Deklat deur binnen Plinthe porte intérieur Listón puerta dentro Door ledge inner Listelli interni porta Letvica za znotraj		1845	18	45		2
21831	V	Frontaussteifung Voorwandversteving Entretoise frontale Refuerzo delantero Front reinforcement Rinforzo parete frontale Sprednje vezje		1809	18	45	Leiste Lat Plinthe Listón Ledge Corrente Letvica	1
21831	M	Deckenleiste Deklat plafond Plinthe de plafond Listón del techo		1809	18	45	Leiste Lat Plinthe Listón	2
21831	M	Cornice Correnti del soffitto Stropna letvica		1809	18	45	Ledge Corrente Letvica	2
26575	N	Dachplatte Dakplaat Panneau de toit Placa del tejado Roof plate Tavole del tetto Stropna plošča		1338	918	55	Vormontiert Voorgemonteerd Prémonté Premontado pre-assembled Premontato Predmontirano	2
20799	W	Dachverbindungsleiste Dakverbindingsstrip Plinthe de raccordement du toit Listón de unión del tejado Roof joint ledge Correnti di collegamento del tetto Letvica za povezavo strehe		1920	3,5	20	Leiste Lat Plinthe Listón Ledge Corrente Letvica	1
20527	P	Tür incl. Beschläge Deur incl. hang- en sluitwerk Porte, garnitures comprises Puerta incl. guarniciones Door including fixtures Porta, incl. cerniere Vrata in okovje		1911	815	38	Vormontiert Voorgemonteerd Prémonté Premontado pre-assembled Premontato Predmontirano	1
48541	T	Brett Kranz Kranslijst Planche couronne Tabla corona Board face Asse marcapiano Deska, sprednji del		2000	17	58	Glattkant Gladde kant Angle lisse Borde liso smooth-edged Premontato Gladki rob	3
48541	U	Brett Aufrecht Plank verticaal Planche verticale Deska, navpična Tabla vetical Board upright Asse verticale Deska, navpična		2000	17	58	Glattkant Gladde kant Angle lisse Borde liso smooth-edged Bordo levigato Gladki rob	2
48545	S	Brett Aufrecht 45 grad Plank verticaal 45 graden Planche verticale 45 degrés Tabla vertical 45 grados Board upright 45 degrees Asse verticale a 45°		2000	17	58	Glattkant Gladde kant Angle lisse Borde liso smooth-edged Bordo levigato	4

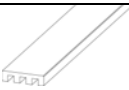
Art.Nr. Art.-nr. Art. N°: N° Art. Art. no. Art.N°: Št. art.:	Nr Nr. N° N° No N°. Št.	Bezeichnung Benaming Designation Denominación Description Descrizione Opis	Bild Afbeelding Dibujo Illustration Immagine Slika	Länge Lengte Longueur Long. Length Lungh. Dolžina	Breite Breedte Largeur Ancho Width Largh. Širina	Stärke Dikte Épaisseur Espesor Thick-ness Spess. Debelina	Material Materiaal Matériau Material Material Materiale Material	Stück Aantal Pièce Ctdad. Number Q.tà Kos
		Deska, navpična 45°					Gladki rob	
21767	L1	Liege Ligbank Banc Banco Bench Panca Klop		1810	550	90	Vormontiert Voorgemonteerd Prémonté Premontado pre-assembled Premontato Predmontirano	1
26576	L2	Bench Panca Klop		1810	250	90	pre-assembled Premontato Predmontirano	1
20896	L3	Liegenblende Afwerklát ligbank Rebord banc Cubierta del banco Bench covering Tavola di chiusura della panca Letev za klop		1810	19	90	Leiste Lat Plinthe Listón Ledge Corrente Letvica	2
40301	L5	Liegenhalterung Ligbankhouder Support de banc Soporte del banco Support for bench Supporto della panca Držalo za klop		555	45	45	Leiste Lat Plinthe Listón Ledge Corrente Letvica	2
3863	L6	Support for bench Supporto della panca Držalo za klop		250	45	45	Leiste Lat Plinthe Listón Ledge Corrente Letvica	2
26717	L7	Bank Distanzstück Bank afstandsstuk Banc pièce d'écartement Banco distanciador Bench spacer piece Distanziatore panca Distančnik za klop		550	18	45	Leiste Lat Plinthe Listón Ledge Corrente Letvica	2
26716	L8	Bench spacer piece Distanziatore panca Distančnik za klop		250	18	45	Leiste Lat Plinthe Listón Ledge Corrente Letvica	2
15490	O1	Ofenschutz Front Rück Kachelbeschermrekje voor/achter Protection de poêle devant/derrière Protección del horno delantera/trasera Oven protection front rear Protezione della stufa anteriore e posteriore Zaščita za peč, spredaj in zadaj		565	18	95	Brett Plank Planche Tabla Board Tavoletta Deska	4
20930	O2	Ofenschutz Seite Kachelbeschermrekje zijkant Protection de poêle côté Protección del horno lateral Oven protection side Protezione laterale della stufa Zaščita za peč, s strani		480	18	95	Brett Plank Planche Tabla Board Tavoletta Deska	4
24796	O3	Ofenschutzstütze Pootje kachelbeschermrekje Support protection de poêle Apoyo protección del horno Oven protection support Supporti della protezione della stufa Podpornik za peč Podpornik za peč		800	18	45	Leiste Lat Plinthe Listón Ledge Corrente Letvica	2
15493	O6	Supporti della protezione della stufa Podpornik za peč Podpornik za peč		800	28	58	Leiste Lat Plinthe Listón Ledge Corrente Letvica	2
19130	O5	Abluftregelbrett Plankje regeling luchtafvoer Planche de régulation de l'air Tabla reguladora de la salida de aire Exhaust air control board Tavoletta di regolazione della ventilazione Regulacijska letvica za odvod zraka		300	18	95	Brett Plank Planche Tabla Board Tavoletta Deska	1
26480	O9	Kabelleiste Afdeklát bedrading Plinthe à câbles Listón de cables Cable cover strip Listello per i cavi Letvica za kabel		1825	26	110	Brett Plank Planche Tabla Board Tavoletta Deska	1

						
Beschlagbeutel:	Zak met onderdelen hang- en sluitwerk:	Sachet garnitures:	Bolsa de guarniciones	Bag of fixtures:	Sacchetto della ferramenta	Pritrdilni material

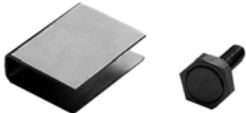
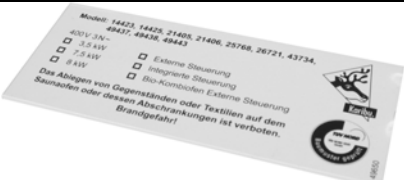





Art.-Nr. Art.Nr. Art. N° N° Art. Art. no. Art. N° Št. art.:	Beschlag Beslag Garniture Guarnición Fixture Ferramenta Okovje	Größe Maat Taille Dimens. Size Dimens. Velikost	Bemerkung Opmerking Remarque Observación Remarks Nota Opomba	Stück Aantal Pièce Ctdad. Number Q.tà Kos
3686	Spax	4 30		20
3687	Spax-schroeven	4 35		60
21925	Vis Spax	4 40		350
3688	Tornillo Spax	4 50		30
9204	Spax joint	4,5 80		25
26715	Viti a croce	6 90		80
14014	Spax vijak	6 60		20
26285	Spax Kopflochgebohrt Spax-schroeven met kopgat Vis Spax tête percée Tornillo Spax cabeza perforada Spax joint with drilled access hole Viti a croce a testa perforata Spax vijak z ugrezno glavo	4,5 40		50
26116	Abdeckkappe Afdekkapje Capuchon Tapa Cover cap Tappi Pokrivna kapa			50
14025	Dichtband Afdichttape Bande d'isolation Cinta aislante Sealing tape Nastro sigillante Tesnilni trak			10m
22047	Türmagnetset Deurmagneetset Set d'aimant de porte Juego magnético puerta Door magnet set Set serratura magnetica della porta Set magnetov za vrata			2
14018	Gewindeschraube mit Scheibe und Mutter Tapschroef met sluitring en moer Vis fileté avec rondelle et boulon Tornillo de rosca con arandela y tuerca Threaded screw with washer and nut Vite filettata con rondella e bullone Navojni vijak s podložko in matico	8 70	nur bei Modellen mit 3 Liegen alleen bij modellen met 3 ligbanken Seulement pour modèles à 3 bancs Sólo en modelos con 3 bancos only for models with three benches solo per i modelli con 3 panche samo pri modelih s 3 klopmi	3
20803	Winkel Hoekijzer Équerre Ángulo Bracket Angolare Kotnik			2
64231	TÜV-Schild für Saunaofen inkl. 4 Schrauben TÜV znak za peč vklj. s 4 vijaki			1







						
Was mit welchem Verbindungsmittel verbunden?	Wat wordt met welk verbindingsmiddel met elkaar verbonden?	Qu'est-ce qui est joint ensemble, et avec quels moyens de fixation ?	¿Qué se une a qué y con qué medio de unión?	What is joined to what with which fixture?	Cosa va fissato con cosa?	Kaj povezati s katerim sredstvom?







Elemente Elementen Eléments Elementos Element Elementi Elementi	Beschlag Beslag Garniture Guarnición Fixture Ferramenta Okovje		Stk. Aant. Pièce Ctdad Number Q.tà Kos	insgesamt Totaal Total Total Total in tutto Skupaj	∅ Vorbohrung Voorge-boord Percement pretaladro pre-drilling diameter foro Premer izvrtine
Frontaussteifung mit untersten Frontbohlen Voorwandversteving met onderste planken voorwand Entretoise frontale avec madrier le plus inférieur Refuerzo delantero con tablonos delanteros inferiores Front reinforcement with lowermost front board Rinforzo della parte frontale con asse inferiore frontale Sprednje vezje z najnižjo sprednjo desko	Spax 4 x 40 Spax-schroeven Vis Spax Tornillo Spax Spax joint Viti a croce Spax vijak 4 x 40	pro Bohle per plank par madrier por tablón per board per ciascun asse na desko	5	10	3,5
Frontbohlen mit Leiste Tür innen Planken voorwand met deklat deur binnen Madrier frontal avec plinthe porte intérieur Tablonos delanteros con listón puerta dentro Front board with door ledge inner Assi frontali con listello interno della porta Sprednja deska z letvico za vrata, notranja	Spax 4 x 40 Spax-schroeven Vis Spax Tornillo Spax Spax joint Viti a croce Spax vijak 4 x 40	pro Bohlenende per plankeinde par extrémité de madrier por extremo del tablón per board end per ciascuna estremità na konec deske	2	72	3,5
Wandbohlen mit aufrechten Rahmen Wandplanken met hoekstijlen Madrier mural avec cadres verticaux Tablonos de la pared con marco vertical Wall board with upright frame Assi delle pareti con il telaio verticale Stenska deska s pokončnim okvirjem	Spax 4 x 40 Spax-schroeven Vis Spax Tornillo Spax Spax joint Viti a croce Spax vijak 4 x 40	pro Bohlenende per plankeinde par extrémité de madrier por extremo del tablón per board end per ciascuna estremità na konec deske	2	208	3,5
	Spax 6 x 90 Spax-schroeven Vis Spax Tornillo Spax Spax joint Viti a croce Spax vijak 6 x 90	jede 4. Bohle pro Bohlenende Elke 4e plank per plankeinde tous les 4 madriers par extrémité de madrier cada 4° tablón por extremo del tablón per board end, every fourth board ogni 4 assi, per ciascuna estremità dell'asse vsaka 4. deska na konec deske	2	80	5,5





Elemente Elementen Éléments Elementos Element Elementi Elementi	Beschlag Beslag Garniture Guarnición Fixture Ferramenta Okovje		Stk. Aant. Pièce Ctdad Number Q.tà Kos	insgesamt Totaal Total Total Total in tutto Skupaj	Ø Vorbereitung Voorge-boord Percement pretaladro pre-drilling diameter foro Premer izvrtine
Tür mit Wandelement Deur met wandelement Porte avec élément mural Puerta con elemento de la pared Door with wall element Porta con gli elementi delle pareti Vrata s stenskim elementom	Spax 4,5 x 80 Spax-schroeven Vis Spax Tornillo Spax Spax joint Viti a croce Spax vijak 4,5 x 80	pro Rahmenseite per raamwerkkant par côté de cadre por lado del marco per frame side Per ciascun lato del telaio na stran okvirja	3	6	4
Deckenleisten mit Wandelementen Deklat plafond met wandelementen Plinthes de plafond avec éléments muraux Listones del techo con elementos de la pared Cornices with wall elements Correnti del soffitto con gli elementi delle pareti Stropna letvica s stenskimi elementi	Spax 4 x 40 Spax-schroeven Vis Spax Tornillo Spax Spax joint Viti a croce Spax vijak 4 x 40	pro Leiste per afdeklát par plinthe por listón per ledge per ciascun listello na letvico	5	20	3,5
Dach mit Deckenleisten Dak met deklatten plafond Toit avec plinthes de plafond Tejado con listones del techo Roof with cornices Tetto con i listelli del soffitto Strop s stropnimi letvicami	Spax 4 x 50 Spax-schroeven Vis Spax Tornillo Spax Spax joint Viti a croce Spax vijak 4 x 50	pro Dachseite per dakkant par côté du toit por lado del tejado per roof side per ogni lato del tetto na stran strehe	3	18	3,5
Ofenschutz Kachelbeschermekje Protection de poêle Protección del horno Oven protection Protezione della stufa Zaščita za peč	Spax 4 x 35 Spax-schroeven Vis Spax Tornillo Spax Spax joint Viti a croce Spax vijak 4 x 35	pro Ecke per hoek par angle por esquina per corner per ciascun angolo na kot	2	16	3,5
Ofenschutzstützen an Ofenschutz Pootje aan kachelbeschermekje Supports de protection de poêle sur protection de poêle Apoyos de la protección del horno en la protección del horno Oven protection support for oven protection Supporti delle protezioni della stufa con le protezioni della stufa Podporniki za peč na zaščito za peč	Spax 4 x 35 Spax-schroeven Vis Spax Tornillo Spax Spax joint Viti a croce Spax vijak 4 x 35	pro Verbindung per verbinding par raccord por unión per joint per ogni collegamento na povezavo	2	16	3,5
Kabelkanalabdeckung mit Wandelement Afdekking kabelgoot met wandelement Canal de couverture des câbles avec élément mural Cubierta del canal de cables con elemento de la pared Cable channel covering with wall element Rivestimento scanalato dei cavi con l'elemento della parete Kabelski kanal s stenskim elementom	Spax 4 x 35 Spax-schroeven Vis Spax Tornillo Spax Spax joint Viti a croce Spax vijak 4 x 35	nach Bedarf zo veel als nodig selon le besoin según la necesidad as required se necessario po potrebi		bis 4 tot 4 jusqu'à 4 hasta 4 up to 4 fino a 4	3,5
Abluftregelbrett an Wand Plankje regeling luchtafvoer aan de wand Planche de régulation de l'air sur mur Tabla reguladora de la salida de aire a la pared Exhaust air control board on wall Tavoletta di regolazione della ventilazione con la parete Regulacijska letvica za odvajanje zraka na steno	Spax 4 x 50 Spax-schroeven Vis Spax Tornillo Spax Spax joint Viti a croce Spax vijak 4 x 50		1	1	3,5
Türmagnethalter mit Türrahmen Deurmagneethouder met deurkozijn Support d'aimant de porte avec cadre de porte Soporte magnético de la puerta con marco de la puerta Door magnet holder with door frame Serratura a magnete con lo stipite della porta Magnetno držalo za vrata z okvirjem vrat	Spax 4 x 50 Spax-schroeven Vis Spax Tornillo Spax Spax joint Viti a croce Spax vijak 4 x 50	pro Stk per stuk par pièce por unidad per piece per pezzo na kos	2	4	3,5



Elemente Elementen Eléments Elementos Element Elementi Elementi	Beschlag Beslag Garniture Guarnición Fixture Ferramenta Okovje		Stk. Aant. Pièce Ctdad Number Q.tà Kos	insgesamt Totaal Total Total Total in tutto Skupaj	Ø Vorbohrung Voorge-boord Percement pretaladro pre-drilling diameter foro Premer izvrtine
Brett aufrecht und Kranzleisten mit Saunakörper Plank verticaal en kranlijsten met saunacabine Planche verticale et plinthes de couronne avec corps du sauna Tabla vertical y listones de la corona con el cuerpo de la sauna Board upright and cornice ledges with sauna body	Spax Kopflochgebohrt mit Abdeckkappen Spax-schroeven met koptgat en afdekkapje Vis Spax tête percée avec capuchon Spax con cabeza perforada con tapa Spax joint with drilled access hole and cover caps Viti a croce con foro e tappi Spax vijak z ugrezno glavo	pro Stk per stuk par piése por unidad per piece per pezzo na kos	5	45	4
Liegenhalterungen mit Wand Ligbankhouders met wand Supports de banc avec mur Soportes del banco a la pared Supports for benches with wall Supporti delle panche alla parete Držala za klop s steno	Spax 6 x 60 Spax-schroeven Vis Spax Tornillo Spax Spax joint Viti a croce Spax vijak 6 x 60	pro Halterung per houder par support por soporte per support per ciascun supporto na držalo	3	12-15	5,5
Liege mit Wand (durch Bankdistanzstück) Ligbank met wand (m.b.v. bankafstandsstuk) Banc avec mur (par la pièce d'écartement) Banco a la pared (mediante distanciador del banco) Bench with wall (through bench spacer piece) Panca con la parete (tramite il distanziatore) Klop s steno (s pomočjo distančnika za klop)	Spax 6 x 60 Spax-schroeven Vis Spax Tornillo Spax Spax joint Viti a croce Spax vijak 6 x 60	pro Stk per stuk par pièce por unidad per piece per pezzo na kos	3	12	5,5







						
<p>Allgemein: Bitte beachten Sie, das Sie sämtliche Schraubverbindungen vorbohren müssen, um zu verhindern das sich das eingesetzte Holz spaltet. Welches Verbindungsmittel wo eingesetzt wird entnehmen Sie der Tabelle: „Was wird mit welchem Verbindungsmittel miteinander verbunden?“. Dort finden Sie auch die Durchmesser der zu setzenden Vorbohrungen. Die Seitenwände sollten mit Abstand zur Wand montiert werden, damit man die Eckverbindung von außen verschrauben kann. Wenn alle Seitenwände montiert sind kann der Saunakörper an die Wand geschoben werden. Halten Sie jedoch mindestens 10cm Wandabstand ein, um eine lange Lebensdauer Ihrer Sauna zu gewährleisten. Die Seitenwände müssen mit der Wasserwaage ausgerichtet werden. Bitte bauen Sie die Sauna im rechten Winkel auf.</p>	<p>Algemeen: Let op dat u alle schroefverbindingen moet voorboren om te voorkomen dat het gebruikte hout splijt. Welk verbindingsmiddel waar wordt toegepast, vindt u in de tabel: „Wat wordt met welk verbindingsmiddel met elkaar verbonden?“. Daar vindt u ook de diameters van de voor te boren gaten. De zijwanden moeten op enige afstand van de muur worden gemonteerd zodat de hoekverbinding van buitenaf kan worden geschroefd. Als alle zijwanden zijn gemonteerd, kan de saunacabine tegen de muur worden geschoven. Houd echter een afstand tot de muur van ten minste 10 cm om een lange levensduur van uw sauna te waarborgen. De zijwanden moeten m.b.v. een waterpas worden afgesteld. Zorg ervoor dat de sauna haaks wordt opgebouwd.</p>	<p>Généralités : Veuillez observer que vous devez percer auparavant l'ensemble des fixations à vis afin d'éviter que le bois utilisé ne se fende. Pour savoir quel moyen de fixation est utilisé à quel endroit, veuillez consulter le tableau « Qu'est-ce qui est joint ensemble, et avec quels moyens de fixation ? ». Vous y trouverez aussi le diamètre des percements à effectuer. Les murs latéraux devraient être montés avec une certaine distance par rapport au mur pour pouvoir visser le raccord d'angle de l'extérieur. Lorsque tous les murs latéraux sont montés, le corps du sauna peut être poussé vers le mur. Laissez cependant une distance de 10 cm par rapport au mur afin de garantir une durée de vie plus longue à votre sauna. Les murs latéraux doivent être dressés à l'aide d'un niveau. Veuillez à construire le sauna en angle droit.</p>	<p>Generalidades: No olvide que debe preperforar todas las uniones atornilladas para evitar que la madera se abra. De la tabla se desprende donde se utiliza cada medio de unión: "¿Qué se une entre sí y con qué medio de unión?": Ahí, usted encuentra también los diámetros de los pretaladros a realizar. Las paredes laterales deberían montarse con distancia a la pared para que se puedan atornillar las uniones de las esquinas. Cuando se hayan montado todas las paredes laterales, el cuerpo de la sauna puede correrse a la pared. Si bien, mantenga una distancia mínima a la misma de 10 cm para asegurar una larga vida útil de su sauna. Las paredes laterales se han de alinear con el nivel de albañil. Monte la sauna en ángulo recto.</p>	<p>General: Please note that it is necessary to pre-drill all screw connections in order to prevent splitting of the wood used. The table "What is joined to what with which fixture?" describes where which fixtures are used. There you will also find the diameters of for the pre-drilling steps. The side walls should be installed at a distance from the wall, so that the corner joint can be screwed down from the outside. When all side walls are installed, you can push the sauna up to the wall. However, maintain a distance of at least 10cm to the wall in order to ensure a long life for your sauna. Align the side walls with the spirit gauge. Make certain to erect the sauna strictly vertically.</p>	<p>Generalità: Si raccomanda di preforare sempre prima di avvitare, in modo da evitare che il legno si rompa. Nella tabella si può vedere quali viti ed accessori si debbano di volta in volta usare per collegare i pezzi tra loro. „Quali parti vanno collegate tra loro e con quali mezzi?“ Vengono indicati anche i diametri dei fori che si devono eseguire. Le pareti laterali non vanno montate troppo vicino alle pareti della stanza, in modo da poter avvitare gli angoli dall'esterno. Quando tutte le pareti laterali sono montate il corpo della sauna può essere avvicinato alla parete della stanza. Mantenere almeno 10 cm di distanza dalla parete, per assicurare una maggiore durata della sauna. Le pareti laterali vanno orientate con la livella a bolla. Montare la sauna a squadra.</p>	<p>Splošno: Prosimo upoštevajte, da je treba predhodno izvrtati vse luknjice za vijake, da preprečite razcep lesa. Tabela "Kaj povezati s katerim sredstvom?" pove, kje morate uporabiti kateri pritrdilni material. V tej tabeli boste lahko razbrali tudi premere za vrtanje posameznih lukenj. Stranske stene morajo biti nameščene z odmikom od stene, da lahko kotnik privijete z zunanje strani. Ko so vse stranske stene nameštene, lahko savno namestite ob steno. Vseeno ohranite razdaljo vsaj 10 cm od stene, da zagotovite dolgo življenjsko dobo savne. Stranske stene poravnajte z vodno tehniko. Savno namestite pravokotno.</p>
<p>Durch die Charakteristik Ihrer Sauna, einzelne Bohlen übereinanderschichten, kann es zu Höhenunterschieden in den Wänden kommen. Diese sind unerheblich, da Ihre Sauna durch den oberen Kranz eine einheitliche Höhe erhält.</p>	<p>Door de karakteristieke bouw van uw sauna met elkaar overlappende planken kunnen er hoogteverschillen bij de wanden voorkomen. Deze zijn van geen belang omdat uw sauna met de kranlijst bovenop één geheel vormt.</p>	<p>La superposition des mardriers, particularité de votre sauna, peut provoquer des différences de hauteur des murs. Celles-ci sont négligeables dans la mesure où la couronne assure au sauna une hauteur uniforme.</p>	<p>Por las características de su sauna, diferentes tablonos sobrepuestos, se pueden producir diferencias de altura en las paredes. Éstas carecen de importancia dado que su sauna recibe una altura unitaria por la corona superior</p>	<p>Due to the sauna characteristics, with individual boards over one another, differences in the height of the walls may arise. This is of no importance, since the upper face ensures that your sauna has a uniform height.</p>	<p>A seconda delle caratteristiche della Sauna si potrebbero avere differenze di altezza delle pareti a seguito del sovrapporsi delle assi. Ciò è inevitabile, in quanto la sauna ottiene un'altezza omogenea con il marcapiano superiore.</p>	<p>Zaradi karakteristike vaše savne se lahko zgodi, da bodo posamezne deske višje od drugih in tako lahko nastanejo razlike v višini sten. To ni pomembno, saj zaradi zgornjega nadstreška savna pridobi enotno višino.</p>

						
<p>Reihenfolge Aufbau: Als erstes sollten Sie die Türscheibe nach anliegender Anleitung mit dem Türrahmen verbinden. Dann folgt die Montage des Saunagrundkörpers mit Leistenset sowie Türgriff. Bauen Sie danach die Inneneinrichtung wie Ofenschutz, Liegen usw..</p>	<p>Volgorde opbouw: Als eerste moet de glazen deur volgens de bijgaande handleiding aan het deurkozijn worden bevestigd. Daarna volgt de montage van de saunacabine met de afdeklatten en de handgreep van de deur. Monteer daarna de onderdelen van het interieur zoals het kachelbeschermrekje, de ligbanken enz.</p>	<p>Ordre de montage: Monter d'abord la vitre de la porte sur le cadre de porte selon la notice de montage jointe. Ensuite vient le montage du corps du sauna avec le set de plinthes ainsi que la poignée de porte. Procéder enfin à l'assemblage de l'aménagement intérieur tel que protection du poêle, bancs etc.</p>	<p>Secuencia de montaje: Primero una la hoja de la puerta con el marco según las instrucciones adjuntas. Después realice el montaje del cuerpo base de la sauna con el juego de listones así como la empuñadura. Posteriormente monte el equipo interior, como protección del horno, bancos, etc.</p>	<p>Assembly procedure: Firstly, you should attach the door plate to the door frame as described in the accompanying instructions. Then assemble the sauna cabin with the ledge set and the door handle. This is followed by the interior equipment, such as the oven protection, benches, etc.</p>	<p>Montare seguendo le istruzioni: Per prima cosa fissare il vetro della porta agli stipiti della porta, come indicato nelle istruzioni allegate. Segue quindi il montaggio del corpo della sauna, con il set di listelli e la maniglia della porta. Quindi arredare l'interno, con la protezione per la stufa, le panche ecc.</p>	<p>Postopek sestave: Najprej pritrdite vrata na okvir vrat kot je opisano v navodilih. Nato sestavite kabino savne iz priloženih letvic ter ročaj vrat. Temu sledi namestitev notranje opreme, kot so zaščita za peč, klopi itd.</p>
Abb.: --> Abbildung	Abb.: --> afbeelding	Fig.: --> Figure	Ilust.: → Ilustración	Fig.: --> Figure	Imm. Immagine	
<p>Abb.: 1 Hier ist eine bemaßte Draufsicht dargestellt.</p>	<p>Afb.: 1 Hier is een overzichtstekening met maten weergegeven.</p>	<p>Fig.: 1 Aperçu général métré.</p>	<p>Ilust. : 1 Aquí se representa una vista en planta dimensionada</p>	<p>Fig. 1 This figure is a top view showing the dimensions.</p>	<p>Imm. 1 Qui viene rappresentata una pianta con le quote.</p>	<p>Slika 1 Tukaj je predstavljen pogled od zgoraj z merami.</p>
<p>Abb.: 2 Die Wände bestehen aus 40mm Blockbohlen (Pos. A-F) mit Nut und Feder. Diese werden an den Saunaecken durch Pos. H untereinander verbunden. Jede Bohle wird mit 2 Spax 4 x 40 an jedem Ende mit Pos. H verbunden. Die untersten Frontbohlen rechts und links werden mit der Frontaussteifung miteinander verbunden. Legen Sie die Frontaussteifung flach zwischen die aufrechten Rahmen der vorderen Ecken und Verschrauben Sie diese von außen mit der untersten rechten und linken Blockbohle. Im Bereich der Tür werden die Frontbohlen mit Pos.I verbunden. Jede Bohle wird mit 2 Spax 4 x 40 mit Pos. I verbunden. Dabei ist zu beachten, dass Pos I ca. um die Hälfte in den Türbereich hineinragt und auf der Frontaussteifung steht.</p>	<p>Afb.: 2 De wanden bestaan uit 40 mm planken (pos. A-F) met veer en groef. Deze worden bij de hoeken van de sauna via pos. H met elkaar verbonden. Elke plank wordt met 2 spax-schroeven 4x40 op elk uiteinde met pos. H verbonden. De onderste plan-ken rechts en links worden met de voorwandversteving met elkaar verbonden. Leg de voorwandversteving plat tussen de hoekstijlen van de voorste hoeken en schroef ze van buitenaf vast aan het onderste rechter en linker deel. Ter hoogte van de deur worden de voorwandplanken verbonden met pos. I. Elke plank wordt met 2 spax-schroeven 4x40 verbonden met pos. I. Daarbij moet in acht worden genomen dat pos. I ca. voor de helft in de deuropening steekt en op de voorwandversteving staat.</p>	<p>Fig. : 2 Les murs sont composés de madriers de 40mm (pos. A-F) avec rainure et languette. Ils sont reliés entre eux aux angles du sauna par la pos. H. Chaque madrier est relié à chaque extrémité à la pos. H par 2 vis spax 4 x 40. Les madriers frontaux inférieurs gauche et droit sont raccordés avec l'entretoise frontale. Posez l'entretoise frontale à plat entre les cadres verticaux des angles de devant et vissez ceux-ci de l'extérieur avec le madrier gauche et droit inférieur. Dans la zone de la porte, les madriers frontaux sont assemblés à la pos. I. Chaque madrier est assemblé à la pos. I par 2 vis spax 4 x 40. Veiller à ce que la pos. I pénètre env. de moitié dans la zone de la porte et soit posée sur l'entretoise frontale.</p>	<p>Ilust.: 2 Las paredes constan de tablonos en bloque de 40 mm (Pos. A-F) con lengüeta y ranura. Estos se unen a las esquinas de la sauna entre sí por la posición H. Cada tablón se une a cada esquina con Pos. H mediante 2 Spax 4x40. Los tablonos inferiores derecha e izquierda se unen mediante el refuerzo delantero. Ponga el refuerzo delantero plano entre los marcos verticales de la esquina delantera y atornillelo con el tablón inferior derecho e izquierdo. En la zona de la puerta, los tablonos delanteros se unen con la Pos. I. Cada tablón se une con 2 Spax 4x40 con Pos. I. Aquí se ha de tener en cuenta que la Pos I ha de entrar aprox. la mitad en la zona de la puerta y se ha de encontrar encima del refuerzo delantero.</p>	<p>Fig. 2 The walls consist of 40mm block boards (pos. A-F) with tongue and groove. These are joined under each other at the corners of the sauna by pos. H. Each board is attached with two 4 x 40 Spax joints at each end with pos. H. The lowermost front boards right and left are joined using the front reinforcement. Lay the front reinforcement flat between the upright frame of the front corners and attach with the screws from outside to the lowermost right and left block boards. In the area of the door the front boards (pos. I) are joined. Attach each board with two 4 x 40 Spax joints to pos. I. Make certain that approximately half of pos. I projects into the door area and lies on the front reinforcement.</p>	<p>Imm. 2 Le pareti sono fatte di assi da 40 mm (pos. A-F) ad incastro. Esse vengono collegate tra loro agli angoli della sauna con gli elementi in pos. H. Ogni asse viene fissata con 2 viti a croce 4 x 40 ad ognuna delle sue estremità con l'elemento H. L'asse inferiore frontale destra e sinistra vengono collegate tra loro con il rinforzo della parete frontale. Disporre il rinforzo frontale di piatto tra i telai verticali degli angoli anteriori e avvitare dall'esterno con le assi inferiori destra e sinistra. Nella zone della porta le assi frontali vanno fissate all'elemento Pos. I. Ogni asse va fissata con Pos. I con 2 viti a croce 4 x 40. Fare attenzione a che l'elemento Pos. I rientri per metà nell'area della porta e che stia sul</p>	<p>Slika 2 Stene so sestavljene iz 40 mm desk (pos. A -F) z utorom in peresom. Deske na robovih savne povežite s pos. H. Vsako desko na vsakem koncu pritrdite z 2 Spax vijakoma 4 x 40 s pos. H. Najbolj spodnji sprednji deski na levi in desni strani povežite s sprednjim vezjem. Položite sprednje vezje ploščato med pokončni okvir sprednjih robov in ga z zunanje strani pritrdite z vijaki na najnižji levi in desni del deske. Na predelu vrat se združita sprednji deski. Vsako desko pritrdite z dvema 4 x 40 Spax vijakoma na. Prepričajte se, da pos. I sega približno za polovico med področje vrat in</p>

						
					rinforzo della parte frontale.	sprednje vezje.
<p>Abb.: 3 Beim Schrauben auf gleiche Höhe der Bohlen achten. Bitte beim Saunaaufbau der Sauna immer überprüfen ob sie im Lot ist und die Wände rechtwinklig zueinander verlaufen. Lage der Pos.D: als 2. Bohle von unten Lage Pos. G: in der Rückwand als 6. Bohle von unten. Achtung! Bitte jede 4.Bohle mit den größeren Schrauben befestigen. dabei mit in die andere Bohle schrauben (Detail)</p>	<p>Afb.: 3 Let bij het schroeven op een gelijke hoogte van de planken. Controleer bij de montage van de sauna altijd of deze in het lood staat en de wanden haaks op elkaar staan. Plaats van pos. D: als 2e plank van onderen Plaats pos. G: in de achterwand als 6e plank van onderen. Let op! Bevestig a.u.b. elke 4e plank met de grotere schroeven. Daarbij tevens in de andere plank schroeven (detail)</p>	<p>Fig.: 3 Veiller à ce que les madriers soient à une hauteur identique lors du vissage. Durant le montage, vérifiez régulièrement que le sauna est d'aplomb et que les murs sont tous à angles droits. Situation de la pos. D : comme 2ème madrier à partir du bas Situation de la pos. G : dans le mur arrière, comme 6ème madrier à partir du bas. Attention : Fixer chaque 4ème madrier avec les vis plus grosses et visser deux madriers ensemble (détail).</p>	<p>Ilust.: 3 Al atornillar, cerciorarse que los tablonos estén a la misma altura. Al montar la sauna comprobar siempre que esté perpendicular y las paredes formen ángulos rectos. Situación de la Pos. D: como 2º tablón desde abajo Situación de la Pos. G: en la pared posterior como 6º tablón desde abajo Atención: Fijar cada 4º tablón con el tornillo más grande. Fijar este tablón con el otro. (Detalle)</p>	<p>Fig. 3 Make certain to attach the screws at the same height to the boards. When erecting the sauna, always make certain that it is standing upright and the walls are perpendicular to each other. Location of pos. D: as second board from bottom Location of pos. G: in rear wall as sixth board from bottom. Attention! Attach each fourth board with the large screws. Drive the screws into the other board (Detail).</p>	<p>Imm. 3 Nell'avvitare fare attenzione a che le assi siano alla stessa altezza. Durante la costruzione della Sauna controllare sempre che essa sia a piombo e che le pareti siano ad angolo retto tra loro. Posizione dell'elemento Pos. D: seconda asse da sotto Posizione dell'elemento Pos. G: nella parete posteriore, 6° asse da sotto. Attenzione! Ad ogni 4.a asse utilizzare una vite più grossa per il fissaggio. Avvitare così anche nell'altra asse (dettaglio)</p>	<p>Slika 3 Vijake pritrdite na isto višino deske. Ko boste savno dvignili, se prepričajte, da bodo stene navpične in stranice med seboj pravokotne. Lokacija pos. D: kot druga deska s spodnje strani. Lokacija pos. G: na zadnji steni kot šesta deska s spodnje strani. Pozor! Vsako četrto desko pritrdite z velikimi vijaki. Vijake privijte v drugo desko (detajl).</p>
<p>Abb.: 4 Alle Bohlen aufschichten und verschrauben. Bitte auf gleiche Höhe der einzelnen Bohlenreihen achten. Damit die Bohlen fest aufeinander sitzen mit einem Gummihammer die Bohlen fest aufeinander bringen. Die Font erhält oben als Abschluss eine durchgehende Bohle. Achtung: Die Pos H ist nicht so hoch wie eine fertige Wand (Detail 5).</p>	<p>Afb.: 4 Alle planken aanbrengen en vastschroeven. Let op de gelijke hoogte van de verschillende rijen planken. Om ervoor te zorgen dat de planken stevig op elkaar zitten dient u de planken met een rubberhamer stevig op elkaar te slaan. De voorzijde krijgt aan de bovenzijde als afsluiting een doorlopende plank. Let op: Pos H is niet zo hoog als een kant-en-klaar gemonteerde wand (detail 5).</p>	<p>Fig.: 4 Superposer tous les madriers et les visser. Veiller à ce que les rangs de madriers atteignent la même hauteur. Donner quelques coups de marteau en caoutchouc afin d'obtenir une superposition solide des madriers. Un madrier d'une pièce termine le front supérieur. Attention : la pos. H n'est pas aussi haute que le mur terminé (détail 5).</p>	<p>Ilust. : 4 Sobreponer todos los tablonos y atornillarlos. Cerciorarse que todas las líneas de tablonos tengan la misma altura. Para que los tablonos queden bien fijados unos sobre otros, ayudarse de una maza de goma. La parte delantera recibe arriba un tablón continuo como final. Atención: Las Pos H no es tan alta como una pared terminada. (Detalle 5)</p>	<p>Fig. 4 Stack all boards and attach with the screws. Make certain of the same height in the different rows of boards. In order to ensure that the boards lie firmly over each other, use a rubber hammer when laying the boards over each other. Attention: Pos. H and I are not as high as an assembled wall Screw down in the area of the door - pos. J.</p>	<p>Imm. 4 Disporre tutte le assi ed avvitarle. Controllare che le singole file di assi siano alla stessa altezza. Per fissare bene le assi una sull'altra farle entrare bene negli incastri con un martello di gomma. La parte frontale va chiusa sopra con un'asse che si estende per tutta la sua lunghezza. Attenzione: La Pos. H non va disposta alla stessa altezza della parete finita (dettaglio 5).</p>	<p>Slika 4 Vse deske z vijaki pritrdite eno nad drugo. Bodite pozorni, da bo vsaka vrsta na enaki višini. Da bi bile deske trdno pritrjene ena na drugo, pri polaganju uporabite gumijasto kladivo. Spretnji del na vrhu dobi še finalno zaključno letvico. Pozor: Pos H in I nista tako visoki kot sestavljena stena (detajl 5).</p>
<p>Abb.: 5 Jetzt wird die fertig montierte Tür eingesetzt. Der Türausschnitt muss nach oben hin erweitert werden. Sägen Sie den Türausschnitt so zu, dass er eine Höhe von 188cm hat Den Türrahmen mit 3 Stk. 4,5 x 80 Spax je Seite mit den</p>	<p>Afb.: 5 Nu wordt de kant en klaar gemonteerde deur geplaatst. De deuruitsparing moet naar boven toe groter worden gemaakt. Zaag de deuruitsparing zodanig uit dat deze een hoogte van 188 cm heeft. Bevestig het deurkozijn met 3 stuks 4,5x80 spax-schroeven per</p>	<p>Fig.: 5 Installer maintenant la porte déjà montée. L'ouverture de la porte doit être agrandie. Sciez l'ouverture de porte de manière à avoir une hauteur de 188 cm. Fixer le cadre de la porte avec les parties frontales avec 3 vis</p>	<p>Ilust.: 5 Ahora se coloca la puerta ya montada. El recorte de la puerta se ha de ampliar hacia arriba. Sierre el recorte de tal forma que tenga una altura de 188 cm. Fijar el marco de la puerta con los delanteros con 3 Spax</p>	<p>Fig. 5 Then set in the already assembled door. The door recess must be lengthened upwards. Saw out the door recess so that it has a height of 188cm. Attach the door frame with three 4.5 x 80 Spax joints</p>	<p>Imm. 5 Ora inserire la porta già montata. L'apertura per laporta deve essere allargata verso l'alto. Segare l'apertura della porta in modo che sia alta 188 cm. Fissare il telaio della porta</p>	<p>Slika 5 Nato vstavite že sestavljena vrata. Izrez za vrata mora biti zgoraj podaljšan. Z žago naredite izrez za vrata tako, da bo imel višino 188 cm. Okvir za vrata s 3 Spax vijaki 4,5 x 80 na vsaki strani pritrdite na sprednjo</p>

 <p>Fronten befestigen. Bitte dafür die Vorbohrungen verwenden und diese danach mit den Abdeckkappen des Beschlagbeutels für die Tür verschließen.</p> <p>Die Deckenleisten montieren mit je 5 Spax 4 x 50 pro Leiste an den Wänden. Oberkante Pos. M = Oberkante Pos H. Darauf das Dichband kleben.</p>	 <p>kant aan de voorwanddelen. Gebruik daarvoor de voorgeboorde gaten en sluit deze daarna af met de sierdopjes uit de zak met hang- en sluitwerkonderdelen voor de deur. Monteer de deklatten voor het plafond met elk 5 spax-schroeven 4x50 per lat aan de wanden. Bovenkant pos. M = bovenkant pos. H. Plak daarop het afdichttape.</p>	 <p>spax 4,5 x 80 par côté. Utiliser les percements préalables et les fermer ensuite à l'aide des capuchons fournis dans le sachet de garnitures.</p> <p>Monter les plinthes du plafond sur les murs à l'aide de 5 vis spax 4 x 50 par plinthe. Rebord supérieur pos. M = rebord supérieur pos. H. Coller la bande d'isolation par-dessus.</p>	 <p>4,5 x 80 por lado. Por favor, utilice las perforaciones previas y ciérrelas posteriormente con las tapas de la bolsa de guarniciones para la puerta.</p> <p>Montar los listones del techo a las paredes con 5 Spax 4x50 por listón. Borde superior Pos. M = Borde superior Pos. H. Pegar sobre ellos cinta aislante.</p>	 <p>to the front on each side. Use the pre-drilled holes and close these off afterwards with the cover caps from the bag of fixtures for the door.</p> <p>Install each of the cornices with five 4 x 50 Spax joints on the walls. The upper edge of pos. M must be flush with the upper edge of pos H. Cover over with sealing tape.</p>	 <p>alla parte frontale con 3 viti a croce da 4,5 x 80 per parte. Inserire le viti nei fori predisposti e quindi apporre gli appositi tappi che troverete nel sacchetto della ferramenta.</p> <p>Montare sulle pareti i cornici del soffitto con 5 viti a croce 4 x 50 per ciascuno. Spigolo superiore dell'elemento Pos. M = Spigolo superiore dell'elemento Pos. H. Applicarvi il nastro sigillante.</p>	 <p>stranico savne. Uporabite prej izvrtane luknje in jih nato zaprite s kapico iz vreče s pritrdilnim materialom.</p> <p>Stropne letvice namestite tako, da vsako s 5 Spax vijaki 4 x 50 pritrdite na stene. Zgornji rob pos. M mora biti poravnan z zgornjim robom pos. H. Prekrijte s tesnilnim trakom.</p>
<p>Achtung! Unbedingt die Elemente genau ausrichten! Zuerst eine Dachplatte (Pos N) auf Deckenleisten (Dichtband) legen, Dachverbindungsleiste (Pos Q) in Nut der Dachplatte einschieben. Die nächste Dachplatte einlegen. Bei 3 Dachplatten die dritte Dachplatte ebenso ausführen. Die Dachplatten werden von unten mit den Deckenleisten verschraubt.</p>	<p>Attentie! Stel de elementen absoluut nauwkeurig af! Leg eerst een dakplaat (pos. N) op de deklatten (afdichttape), schuif de dakverbindingsstrip (pos. Q) in de groef van de dakplaat. Breng de volgende dakplaat aan. Bij 3 dakplaten met de derde dakplaat op dezelfde manier te werk gaan. De dakplaten worden van onderaf vastgeschroefd aan de deklatten voor het plafond.</p>	<p>Attention! Les éléments doivent être impérativement d'aplomb ! Poser d'abord un panneau de toit (pos. N) sur les plinthes du plafond (bande d'isolation), introduire la plinthe de raccordement du toit (pos. Q) dans la rainure du panneau de toit. Poser le panneau de toit suivant. Avec 3 panneaux de toit, procéder comme ci-dessus pour le 3ème panneau. Les panneaux de toit sont vissés par le bas aux plinthes du plafond.</p>	<p>Atención: Es imprescindible orientar exactamente los elementos. Poner primero una placa del tejado (Pos N) sobre los listones del techo (cinta aislante). Introducir el listón de unión del tejado (Pos Q) en la ranura de la placa del tejado. Si hay 3 placas del tejado, proceder en la tercera en la misma forma. Las placas del tejado se atornillan por debajo con los listones del techo.</p>	<p>Attention! Make certain to exactly align the elements! Firstly lay a roof plate (pos. N) onto the ceiling ledges (sealing tape) and push the roof joint ledge (pos. Q) into the groove of the roof plate. Lay the next roof plate. For three roof plates, lay the third roof plate in the same manner. Screw down the roof plates to the cornices from below.</p>	<p>Attenzione! Si raccomanda di orientare gli elementi con precisione! Dapprima posare una tavola del tetto (pos. N) sui listelli del soffitto (nastro sigillante), quindi inserire i listelli di collegamento del tetto (pos. Q) nella scanalatura delle tavole del tetto. Posare la tavola del tetto successiva. Usare la stessa procedura con la terza tavola del tetto. Le tavole del tetto vanno avvitate da sotto ai cornici del soffitto.</p>	<p>Pozor! Elemente natančno poravnajte! Najprej položite stropno ploščo (pos. N) na stropne letvice (tesnilni trak) in potisnite povezovalno stropno letvico v utor na stropni plošči (Pos. Q). Položite naslednjo stropno ploščo. Postopek ponavljajte dokler ne položite tretje stropne plošče. S spodnje strani privijte stropne plošče na stropno letvico.</p>
<p>Abb.: 6 Pos. U und S werden mit den Schrauben auf den Ecken befestigt. An den Sichtseiten werden die Pos. T oben bündig mit Pos U und S angebracht. Diese Leisten sind länger als benötigt geliefert. Sägen Sie diese das bei Ihnen erforderliche Maß. In der bemaßten Draufsicht (Abb.1) können Sie genauer erkennen, wie welche Leiste an die Sauna befestigt wird.</p>	<p>Afb.: 6 Pos. U en S worden met spijkers op de hoeken bevestigd. Aan de zichtzijden worden de pos. T aan de bovenkant vlak aanliggend met pos. U en S vastgespijkerd. Deze latten zijn met een universele lengte geleverd. Zaag deze op de bij u benodigde lengte. In het bovenaanzicht met maten (afb. 1) kunt u precies zien hoe elke lat aan de sauna wordt bevestigd.</p>	<p>Fig.: 6 Fixer les pos. U et S à l'aide de vis avec capuchons sur les angles. Aux emplacements visibles, la pos. T et les pos. U et S sont placées jointes à niveau dans la partie supérieure. Ces plinthes sont livrées extra-longues, vous pouvez les découper à la longueur nécessaire. Pour voir quelles plinthes sont fixées au sauna : voir aperçu métré (fig. 1).</p>	<p>Ilust.: 6 Las Pos. U y S se fijan a las esquinas con los tornillos con las tapas. En las partes visibles, la Pos. T se dispone arriba y a ras con las Pos U y S. Estos listones se suministran más largos de lo necesario. Siérrelos a la medida necesaria. En la vista en planta medida (Ilust. 1), usted puede reconocer exactamente con qué listón se fija a la sauna</p>	<p>Fig. 6 Attach pos. U and S with screws to the corners. On the visible side, set pos. T flush with the upper end of pos. U and S. These ledges are delivered longer than necessary. Saw them to the required length. In the top view showing the dimensions (Fig. 1) you can recognize better which ledge is attached</p>	<p>Imm. 6 Le Pos. U e S vanno fissate sugli angoli e dotate di tappi. Sul lato a vista va fissato l'elemento Pos. T in modo che sopra sia a filo con gli elementi Pos. U e S. Questi listelli sono più lunghi del necessario. Segarli nella misura necessaria. Nello schema con le quote (imm. 1) si può vedere meglio quale listello va fissato sulla sauna e co-</p>	<p>Slika 6 Z vijaki v kote pritrdite pos. U in S. Na vidni strani pos. T povežite s pos. U in S. Te letvice so daljše kot je potrebno. Odžagajte jih na zahtevano dolžino. Pri pogledu od zgoraj (slika 1), ki prikazuje dimenzije, lahko bolje vidite, katera letvica je pritrdjena na savno.</p>

						
				to the sauna.	me.	
Abb.:L1 Liegenhalterungen montieren Höhe: Die in der Zeichnung angegebenen Maße beachten (Fußboden bis Unterkante Liegenhalterung angegeben).	Afb.: L1 Montage ligbankhouders. Verticale positie / hoogte: zie de in de tekening aangegeven maten (vloer tot onderkant ligbankhouder).	Fig.: L1 Monter les supports de bancs. Hauteur : respecter les dimensions de l'illustration (du sol au bord inférieur support de banc indiqué).	Ilust.: L1 Montar los soportes del banco. Altura: Respetar las dimensiones indicadas en el dibujo. (Indicado suelo hasta borde inferior del soporte del banco)	Fig. L1 Assembling the supports for the benches Height: according to the dimensions given in the drawing (floor to lower edge of support for bench).	Imm. L1 Montare i supporti delle panche. Altezza: Osservare la misura indicata nel disegno (dal pavimento allo spigolo inferiore del supporto della panca).	Slika L1 Sestavljanje podpornikov za klop Višina: upoštevajte dimenzije na sliki (razdalja od tal do spodnjega roba podpornika za klop)
Abb. L2 Hier ist die Lage der Verschraubungen bei dargestellt.	Afb. L2 Hier is de plaats van de schroefverbindingen bij de ligbankhouder weergegeven.	Fig. L2 Illustration de la position des vissages.	Ilust.: 2 Aquí se representa la situación de las atornilladuras.	Fig. L2 This figure illustrates the positions of the screws of the support for the bench and for the stop block.	Imm. L2 Qui sono indicati i punti dove vanno fissate le viti.	Slika L2 Ta slika prikazuje položaje vijakov za podpornike klopi.
Abb.:L3 Hier ist die Lage der Liegenhalterung dargestellt. Zwischen Liegenenden und Saunawänden kommen die Bank Distanzstücke. Die Liegen jetzt mit den Wänden durch die Bankdistanzstücke verschrauben.	Afb.: L3 Hier is de plaats van de ligbankhouder weergegeven. Tussen de uiteinden van de ligbanken en de saunawanden komen de bankafstandsstukken. Schroef nu de ligbanken aan de wanden vast door de bankafstandsstukken heen.	Fig.: L3 Illustration de la position du support de banc. Entre les extrémités du banc et les murs du sauna, placer les pièces d'écartement. Visser maintenant les bancs avec les murs à travers les pièces d'écartement du banc.	Ilust.: L3 Aquí se representa la situación del soporte del banco. Entre los extremos de los bancos y de las paredes se ponen distanciadores. Atornillar ahora los bancos a las paredes mediante los distanciadores	Fig. L3 This figure illustrates the position of the support for the bench. The bench spacer pieces are used between the ends of the benches and the sauna walls. Then screw down the benches to the walls through the bench distance pieces.	Imm. L3 Qui è rappresentata la posizione del supporto della panca. Tra le estremità della panca e le pareti della sauna vanno inseriti i distanziatori della panca. Le panche vengono quindi fissate alle pareti tramite i distanziatori delle panche.	Slika L3 Ta slika prikazuje položaj podpornika za klop. Distančniki za klop se uporabljajo med koncem klopi in stenami savne. Nato klop privijte na steno skozi distančnike.
Abb.:O1 Ofenschutz montieren.	Afb.: O1 Montage kachelbeschermrekje.	Fig. :O1 Monter la protection de poêle.	Ilust.: O1 Montar la protección del horno.	Fig. O1 Install the oven protection.	Imm.: O1 Montare la protezione della stufa.	Slika O1 Namestite zaščito za peč
Abb.:O2 Bringen Sie die Ofenschutzstützen an den Ofenschutz an. Die angegebenen Maße gegebenenfalls an den Ofen anpassen. Ofenschutz möglichst mittig vor das Wandelement mit der Zuluft (Front) stellen. Schrauben Sie es an diese Front an. (Beide Bretter die an der Wand sind anschrauben; X ... Lage Verschraubung) Ausnahme: Produktnummer:	Afb.: O2 Monteer de pootjes aan het kachelbeschermrekje. Pas de aangegeven maten evt. aan de kachel aan. Zet het kachelbeschermrekje zoveel mogelijk midden vóór het wandelement met de luchttoevoer (front). Schroef het vast aan dit voorwandeel. (Beide plankjes die tegen de wand komen vastschroeven; X ... plaats schroeven). Uitzondering: productnummer: 85420, daar komen de schroeven in de	Fig. : O2 Installer les supports sur la protection du poêle. Adapter au poêle les dimensions données si nécessaire. Placer le plus possible la protection de poêle au centre devant l'élément mural avec l'aération (façade). Vissez-la sur cette façade. (Visser les deux planches du mur ; X ... position de vissage). Exception : produit n° 85420, fixation par vis sur le	Ilust.: O2 Coloque los apoyos de la protección del horno en la protección. Adaptar las medidas indicadas al horno si es necesario. Colocar la protección del horno lo más centrado posible delante del elemento de la pared con la entrada de aire (delantero). Atorníllela a la parte delantera. (Atornillar ambas tablas que están en la pared; X ... posición de	Fig. O2 Bring the oven protection support up to the oven protection. Adapt the size of the oven if necessary. Place the oven protection as well centred as possible in front of the wall element with the air inlet (front) and screw down to this front (attach both boards on the wall; X... position of screw attachment) Exception:	Imm.: O2 Fissare i supporti delle protezioni della stufa alle protezioni della stufa. Eventualmente si dovrà adattare alla stufa le dimensioni delle protezioni. Disporre la protezione della stufa il più centralmente possibile rispetto all'elemento della parete con la presa d'aria (frontale). Avvitarla a questa parete frontale. (Avvitarle entrambe le assi alla parete ;	Slika O2 Podpornik za zaščito peči prinesite do zaščite za peč. Če je potrebno, prilagodite velikost peči. Zaščito za peč namestite kolikor se le da v sredino stenskega elementa z dovodom zraka in jo pritrdite z vijaki (obe deski pritrdite na steno; X ... položaj pritrditve). Izjema: št. art. 85420 - tukaj se vijaki pritrdijo iz ožje strani.

						
85420 dort kommen die Schrauben in die Schmale Seite.	smalle kant.	côté étroit.	atornillado) Excepción: número de producto 85420. Aquí se ponen los tornillos en la parte delgada.	product number: 85420 - here the screws are attached from the narrow side.	X ... Posizione viti) Eccezione: Numero prodotto: 85420 in questo caso le viti vanno avvitate sul lato corto.	
Kabelleiste: Wenn Sie die Elektrokabel in der Sauna vom Ofen zum Steuergerät und dann zum Dach verlegen, können Sie mit der Kabelleiste diese Kabel abdecken. Die Leiste hat verschiedene Fräsungen, damit diese für jede Ofenvariante angewendet werden kann. Verwenden Sie die Leiste so wie Sie diese benötigen	Afdeklát bedrading: Als u de snoeren in de sauna van de kachel naar de regelaar en vervolgens naar het dak legt, kunt u achter deze afdeklát de bedrading wegwerken. In de lat zijn verschillende sleuven gefreesd zodat deze voor elke kachelvariant kan worden gebruikt. Gebruik de lat al naar gelang de gekochte kachel.	Plinthes à câbles: Si vous posez les câbles électriques, dans le sauna, allant du poêle vers l'appareil de commande et ensuite vers le toit, vous pouvez recouvrir ces câbles avec la plinthe à câbles. La plinthe a plusieurs fraisages afin de pouvoir être utilisée pour chaque variante de poêle. Utilisez la plinthe comme vous en avez besoin.	Listón para cables: Si usted coloca el cable eléctrico en la sauna desde el horno hasta el aparato de mando y después hasta el techo, lo puede cubrir con el listón de cable. El listón tiene diferentes fresados para que pueda utilizarse en todas las variantes de horno. Utilice el listón tal y como usted lo necesita.	Cable cover strip: If you lay the electric cable in the sauna from the oven to the control unit and then to the roof, you can cover the cable with this cover strip. The cover strip has different millings, so that it can be used with different oven models. Use the cover strip as required.	Listello per i cavi: Quando nella sauna si posa il cavo elettrico che va dalla stufa al comando e quindi fino al tetto, rivestire il cavo con il listello per i cavi. Il listello ha diverse scanalature, per essere utilizzabile con i diversi modelli di stufa. Utilizzare il listello a seconda delle necessità.	Letvica za kabel Če električni kabel v savno položite od peči do nadzorne enote in nato do strehe, lahko kabel prekrijete s to letvico. Letvica ima različne utore, da se jo lahko uporabi z različnimi modeli peči. Uporabite letvico za kabel tako, kot jo potrebujete.
Abb.:O3 Zeichnen Sie die Mitte des Abluftregelbrettchens an. Dies ist die Lage der Vorbohrung für die Schraube. Bohren Sie dort nun vor.	Afb.: O3 Tekén het midden van het plankje voor de regeling van de luchtvoering aan. Hier moet het gaatje voor de schroef worden voorgeboord. Boor nu het gaatje voor.	Fig.: O3 Marquez le milieu de la planchette de régulation de l'air. Ceci est la position du percement pour la vis. Percez ici un trou avant de visser.	Ilust. O3 Marque el centro de la tablita de regulación de aire de salida. Ésta es la situación de la perforación previa para el tornillo. Haga aquí la perforación previa.	Fig. O3 Mark the centre of the exhaust air control board. This is the position of the pre-drilling for the screw. Then carry out pre-drilling.	Imm. O3 Segnare il centro della tavoletta di regolazione della ventilazione. In quel punto si dovrà forare la tavoletta per la vite. Eseguire il foro	Slika O3 Označite sredino letvice za odvod zraka. To je položaj predvrtanja za vijake. Nato izvrtajte luknjo.
Abb.:O4 Legen Sie das Abluftregelbrett mittig über beide Abluftöffnungen der Rückwand. Schrauben Sie es nun mit 1 Spax 4 x 30 an.	Afb.: O4 Brenghet plankje in het midden over beide luchtvoeringopeningen in de achterwand aan. Schroef het er nu met 1 spax-schroef 4x30 aan.	Fig.: O4 Posez la planchette de régulation de l'air au milieu par-dessus les deux ouvertures d'écoulement de l'air du mur arrière. Vissez-la maintenant avec 1 vis spax 4 x 30.	Ilust.: O4 Coloque la tabla de regulación de salida de aire en el centro sobre las aperturas de salida de aire de la pared posterior. Atorníllela con 1 Spax 4x30.	Fig. O4 Place the exhaust air control board in the centre over the two exhaust air openings on the rear wall. Then attach, using one 4 x 30 Spax joint.	Imm. O4 Disporre la tavoletta di regolazione della ventilazione in mezzo alle due aperture di ventilazione della parete posteriore. Avvitarla con una vite a croce 4 x 30.	Slika O4 Letvico za odvod zraka namestite v sredino nad obe odprtini za odvod zraka na zadnji steni. Nato jo pritrdite z uporabo Spax vijaka 4 x 30.
Abb.:O5-7 Hier ist die Funktionsweise des Brettes abgebildet. Regeln Sie damit die Abluft nach eigenen Wünschen.	Afb.: O5-7 Hier is de werking van het plankje afgebeeld. Regel daarmee de luchtvoering naar eigen wens.	Fig.: O5-7 Ceci représente le mode de fonctionnement de la planche. Avec elle, réglez l'écoulement de l'air selon vos désirs.	Ilust. O5-7 Aquí está representada la forma de funcionamiento de la tabla. Con ella, usted puede regular la salida de aire según su deseo.	Fig. O5-7 This figure shows the functional principle of the board. Regulate the exhaust air according to your own wishes.	Imm. O5-7 Viene illustrato il principio di funzionamento della tavoletta di regolazione della ventilazione. Con essa si può regolare a piacere la ventilazione.	Slika O5-7 Ta slika prikazuje funkcionalni princip deske. Odhodni trak lahko uravnate po svojih željah.



Abb.:1





Detail 5

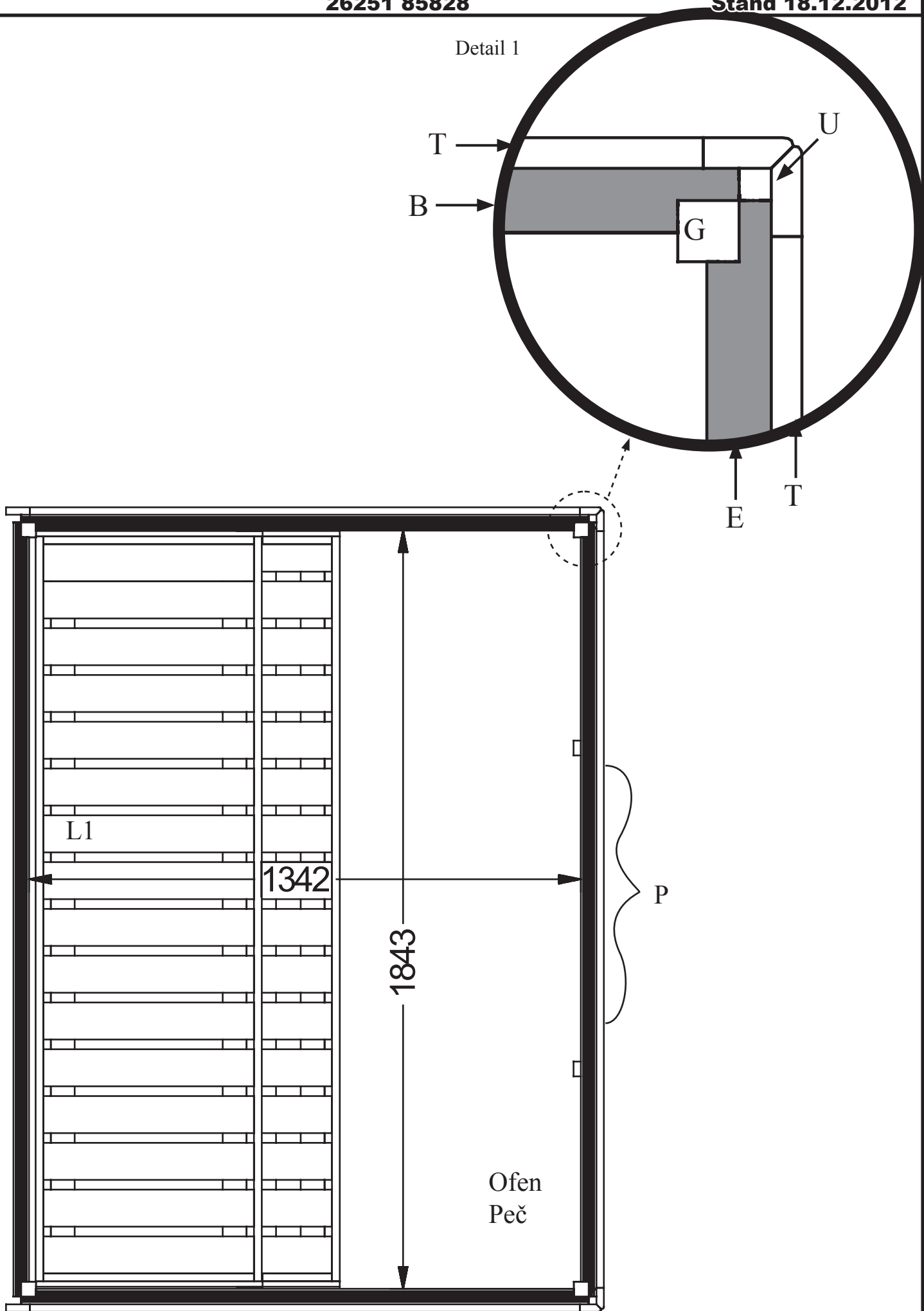
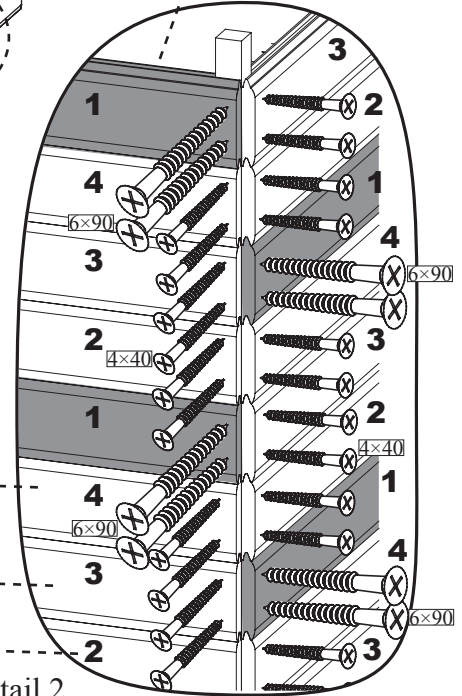
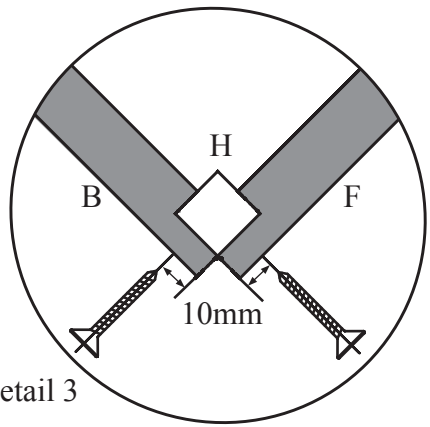
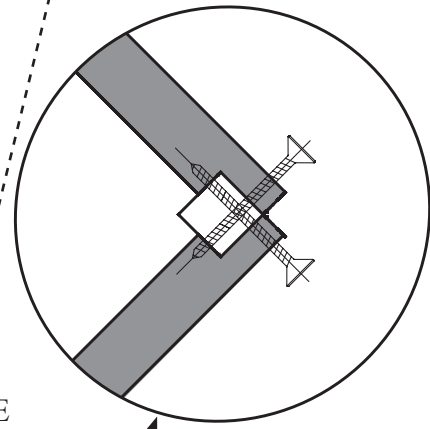
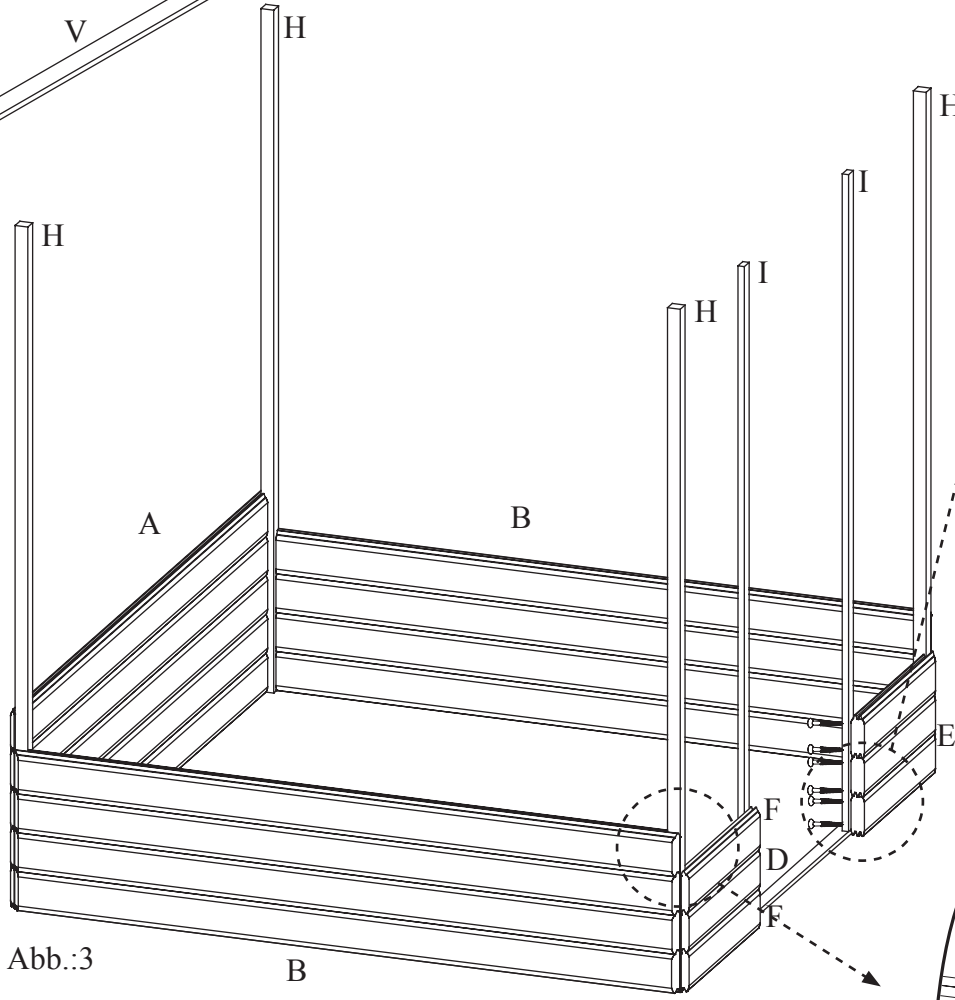
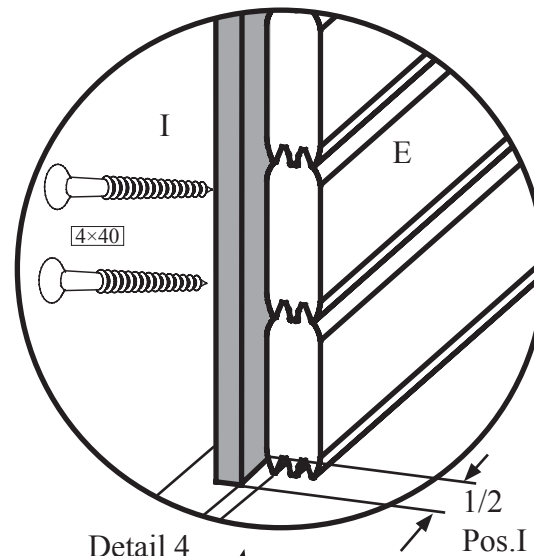
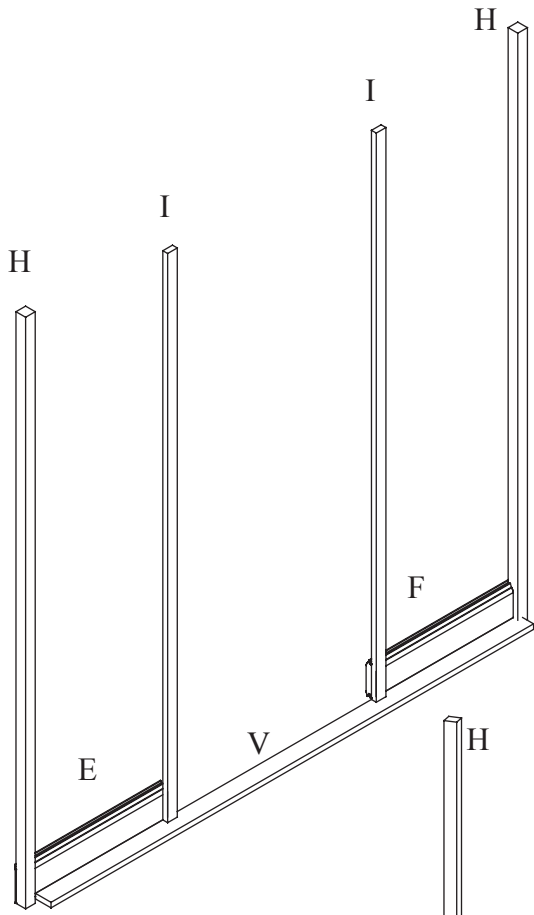
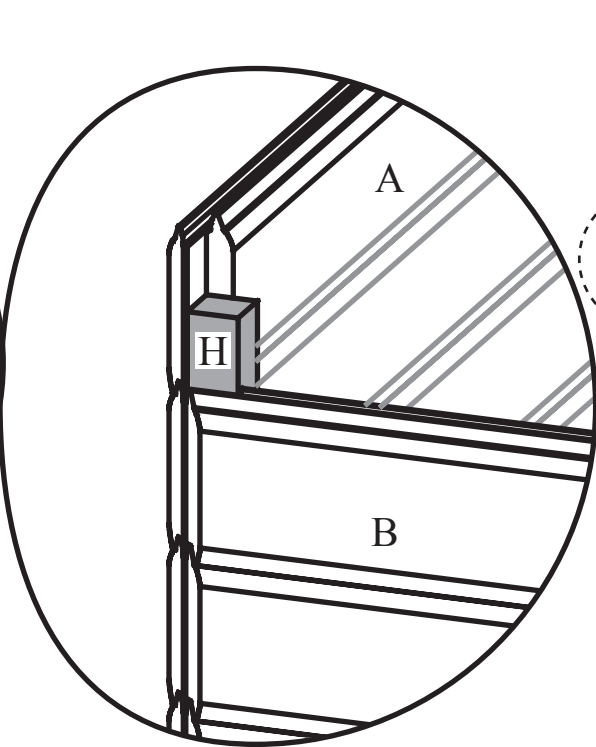

Abb.:4



Detail 6

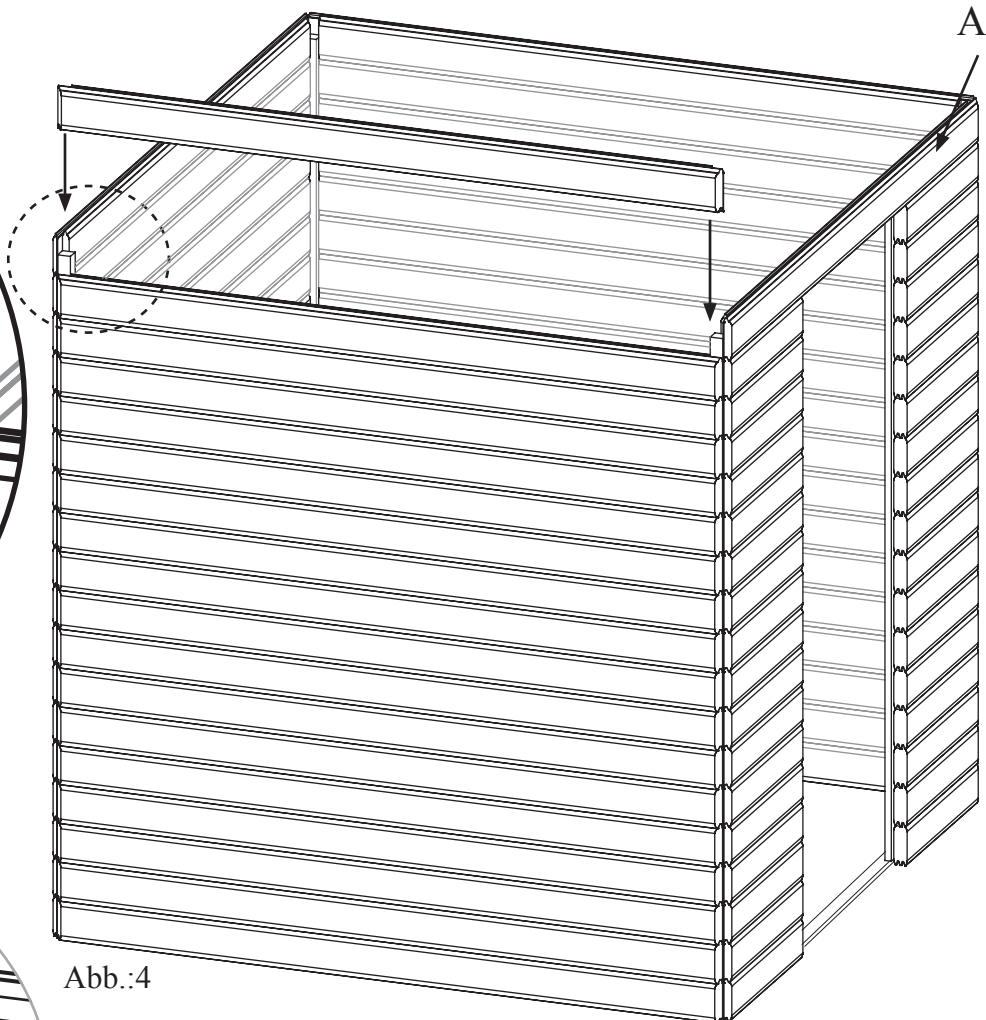
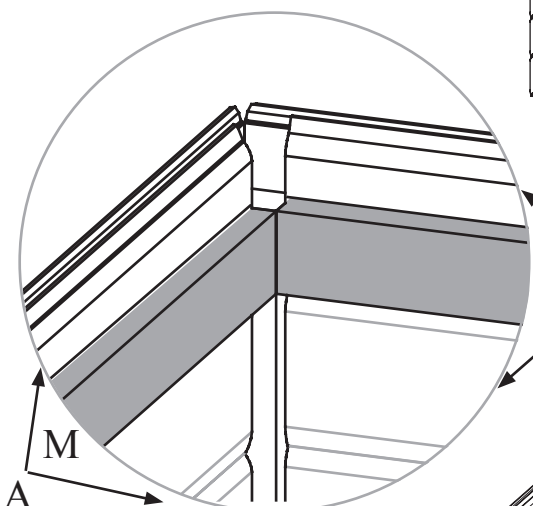

Abb.:5

 Einbau Glastür
 Montage porte en verre
 Installation of glass door
 Montage van de glazen deur
 Montaje de la puerta de cristal
 Installazione portello di vetro
 Montaža steklenih vrat





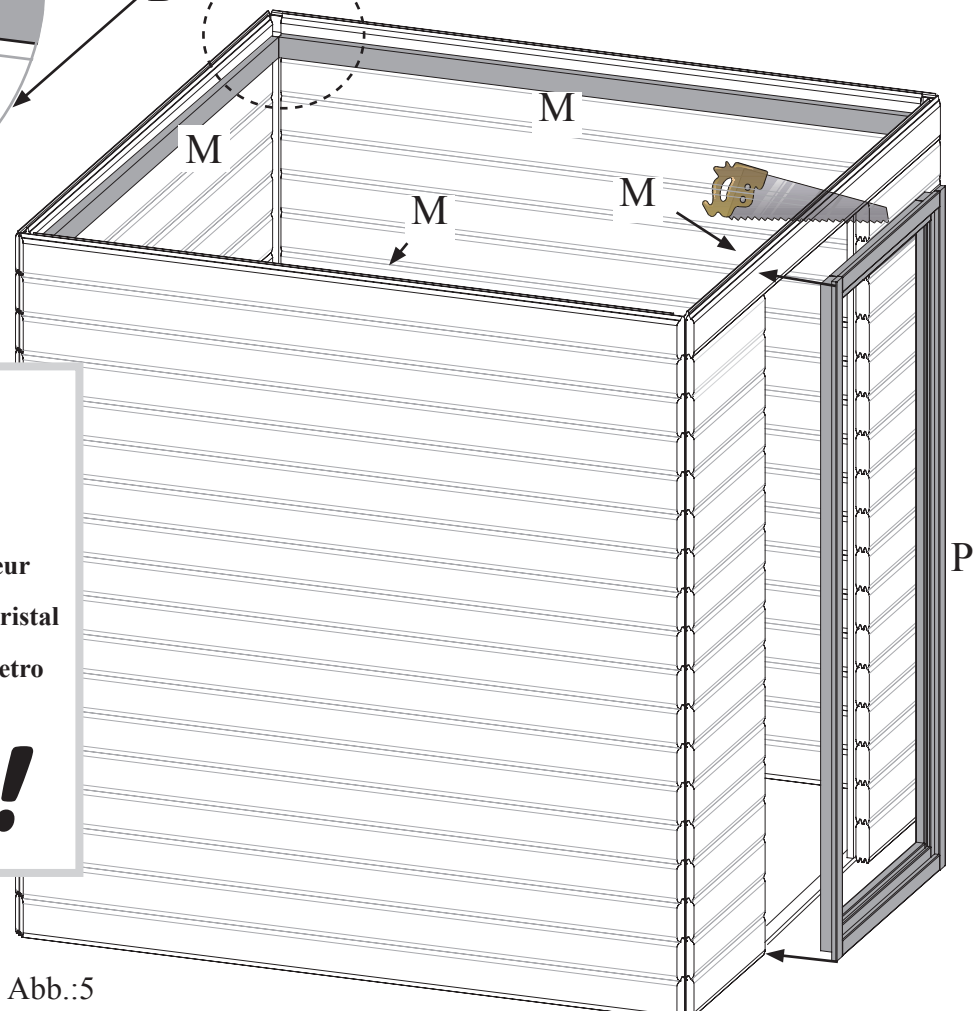



Abb.7



Abb.:L1

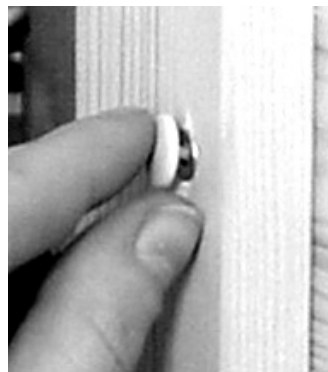
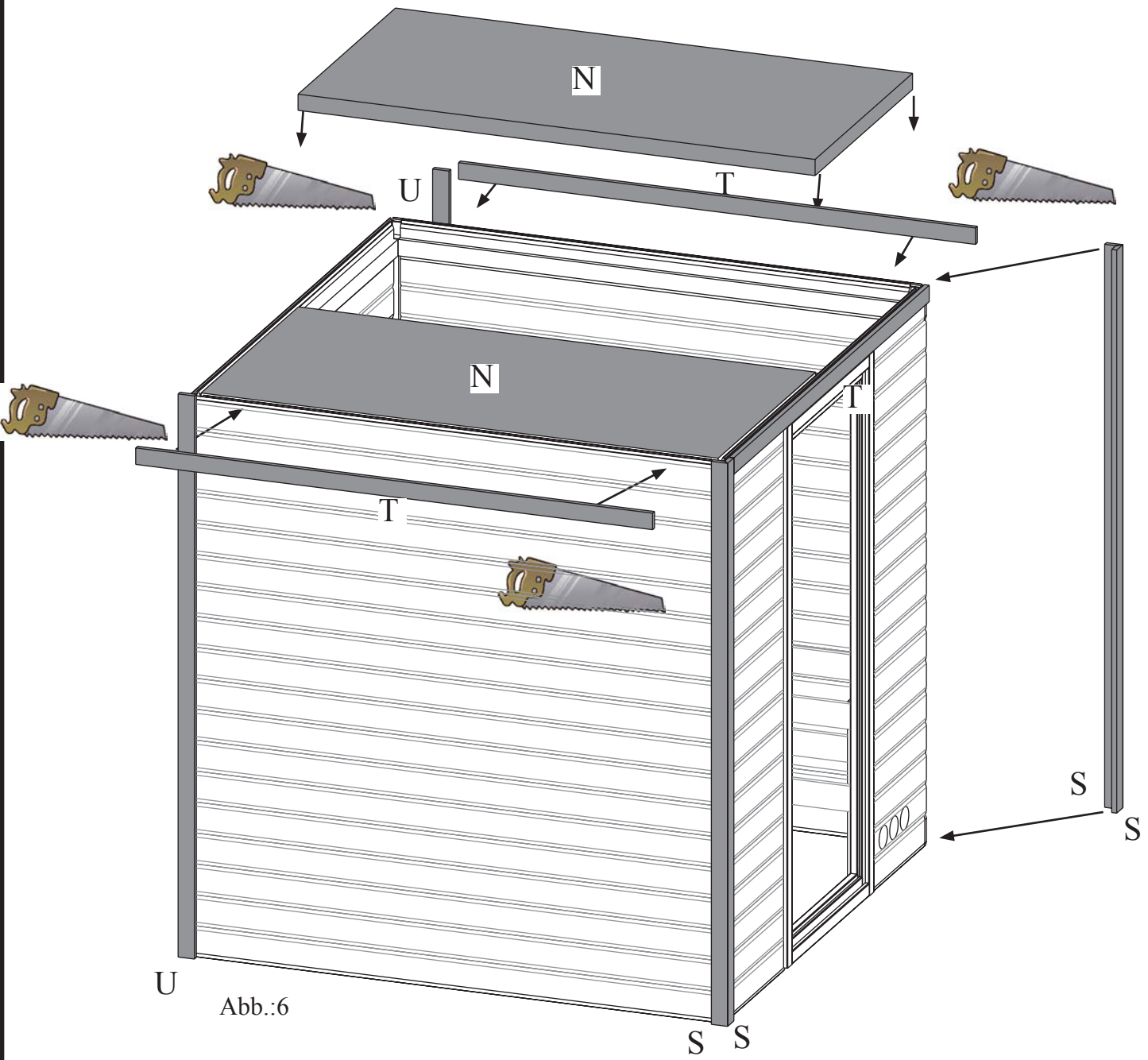

Abb.:L2

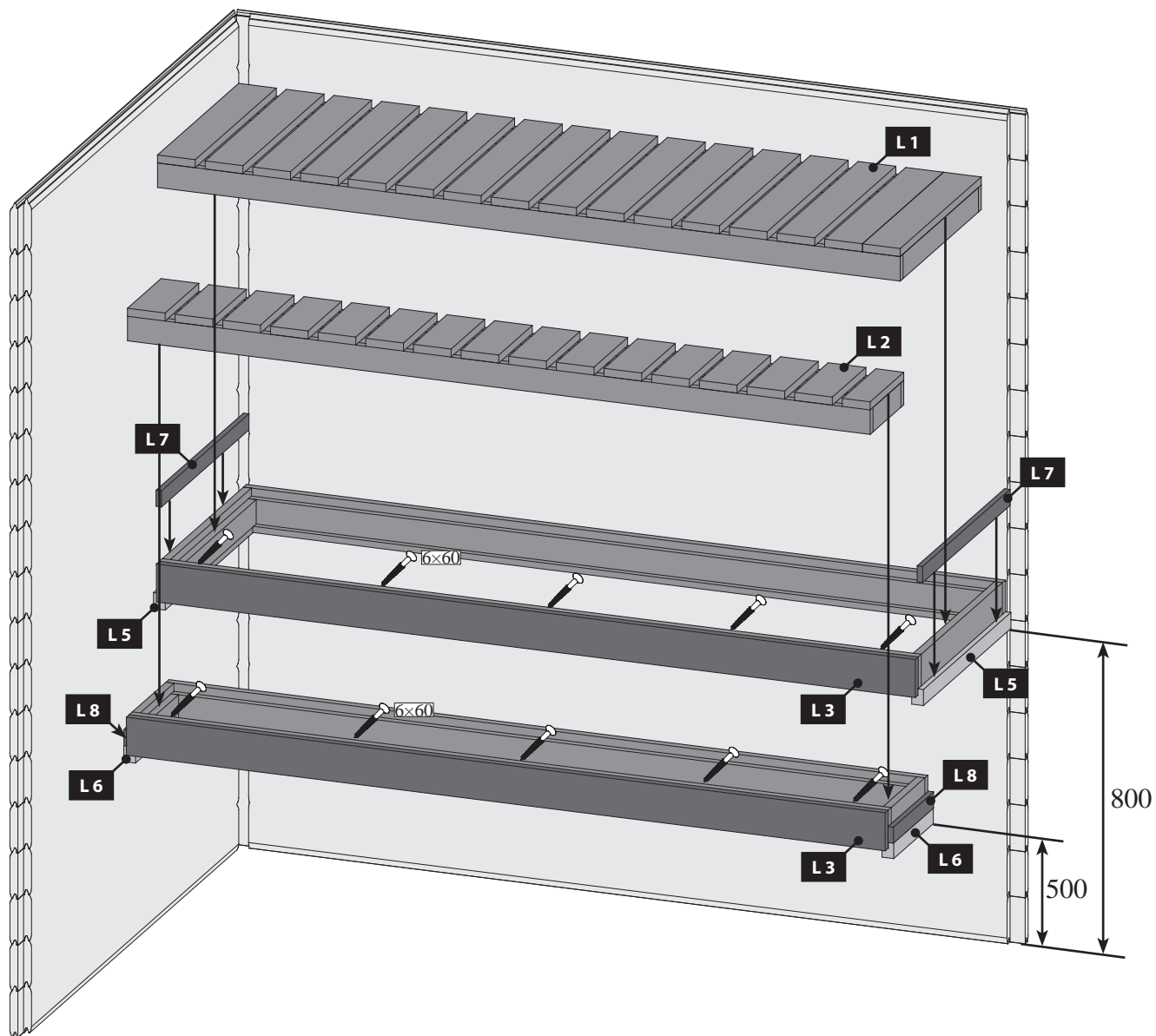

Abb.:L3

01 2x

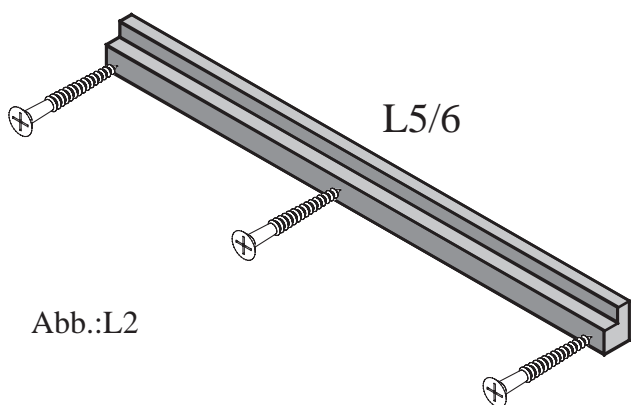

02

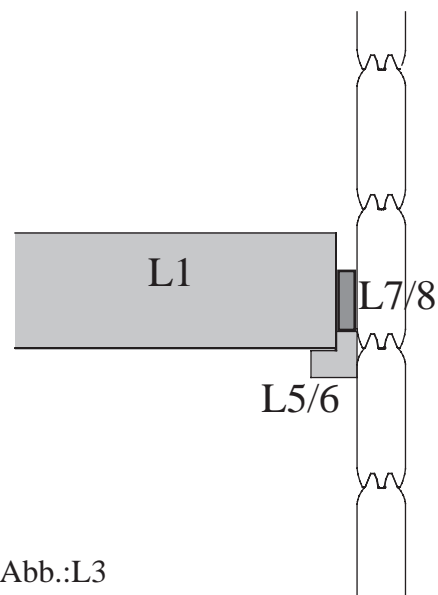
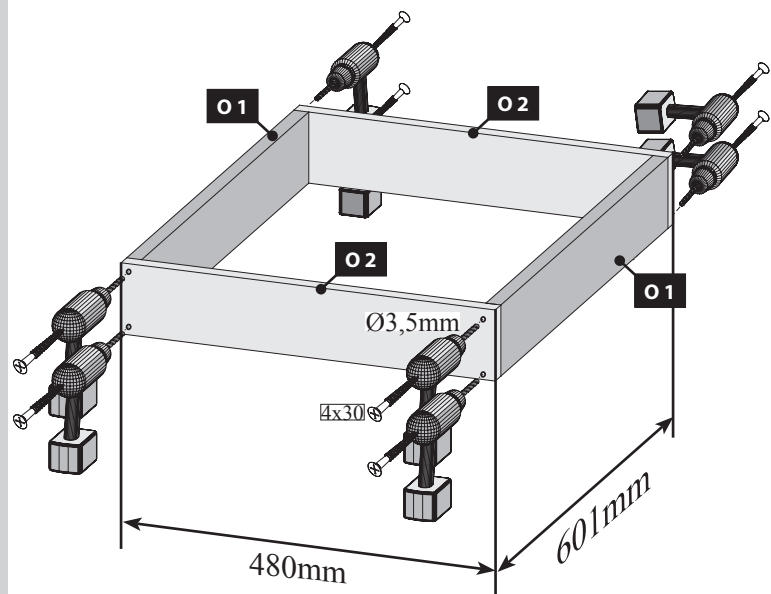
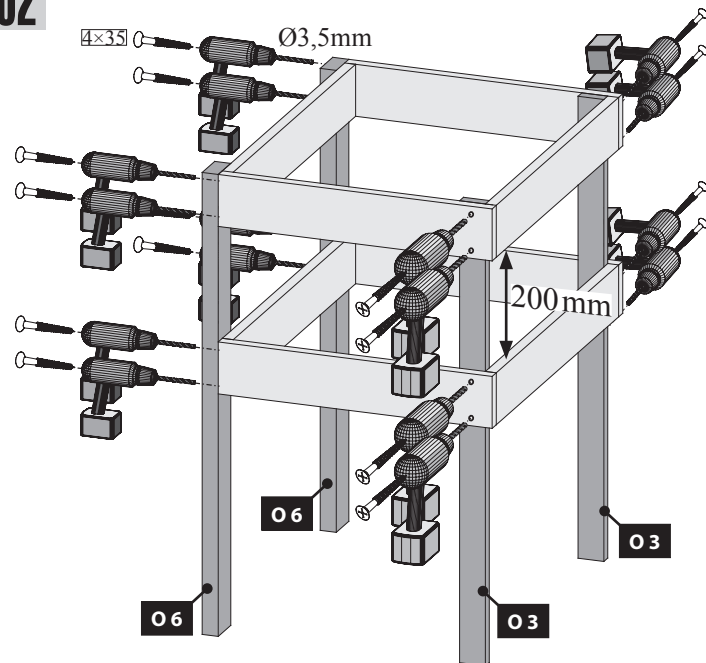

03



Abb. O 1/O 2



-  Einbau Glastür
-  Montage porte en verre
-  Installation of glass door
-  Montage van de glazen deur
-  Montaje de la puerta de cristal
-  Installazione portello di vetro
-  Montáž steklenih vrat

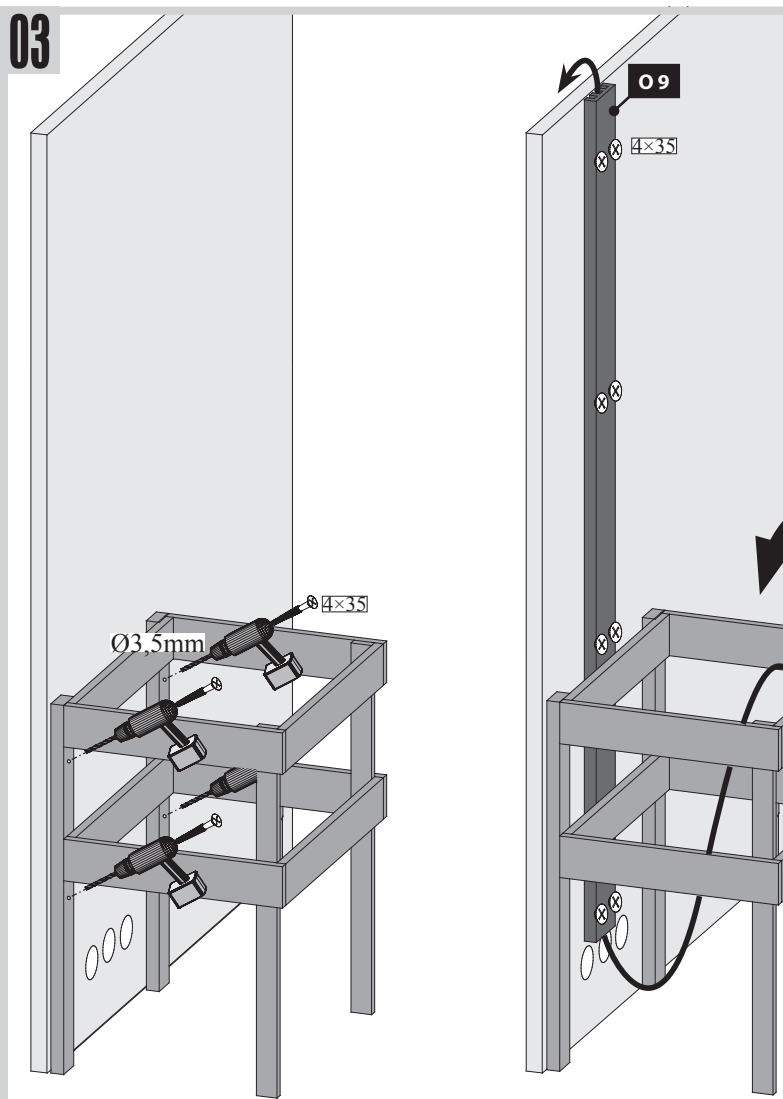

04 — 08



Abb.:03



Abb.:04

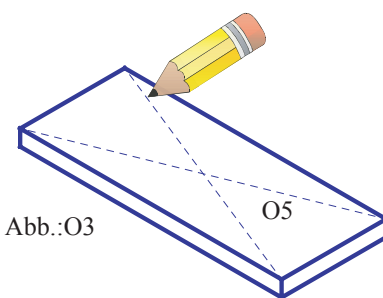

Abb.:05

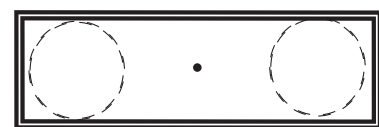

Abb.:06

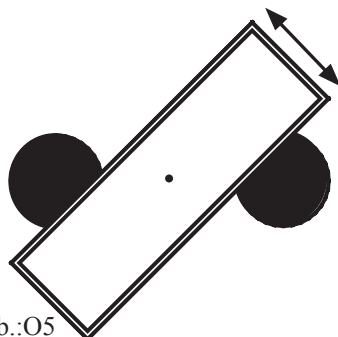

Abb.:07

 Einbau Glastür

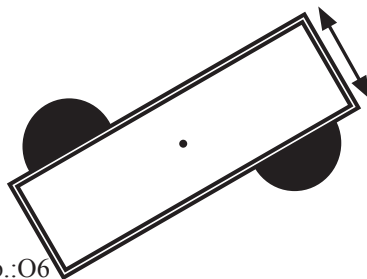
 Installation of glass door

 Montaje de la puerta de cristal

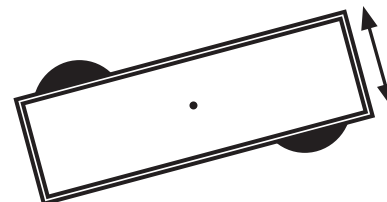
 Montage porte en verre

 Montage van de glazen deur

 Installazione portello di vetro

 Montaža steklenih vrat

01

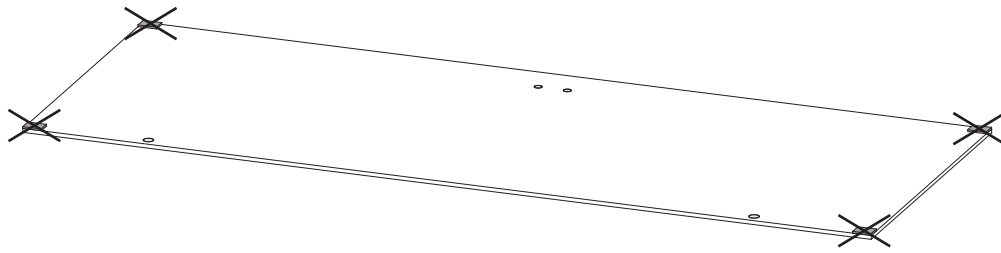

02

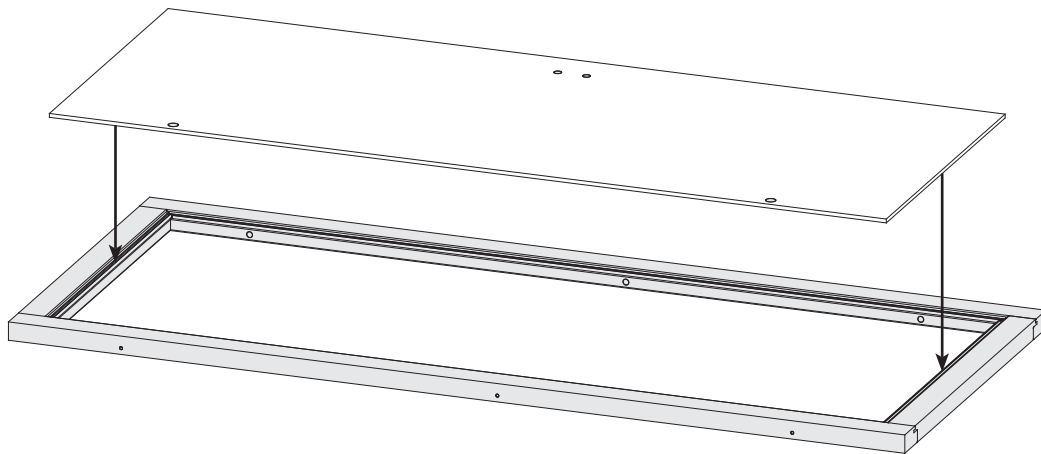

03

 Das Saunatürglas im Türrahmen ausrichten!

 Bien aligner le verre à vitre!

 Steklo namestite v okvir vrat!

 To start building up the door you need to center the glass in the wooden frame!

 Plaats het glas van de sauna deur in het midden van het kozijn!

 Centrar la puerta de cristal dentro del marco!

 Allineare il vetro dello sportello sauna al telaio della porta!

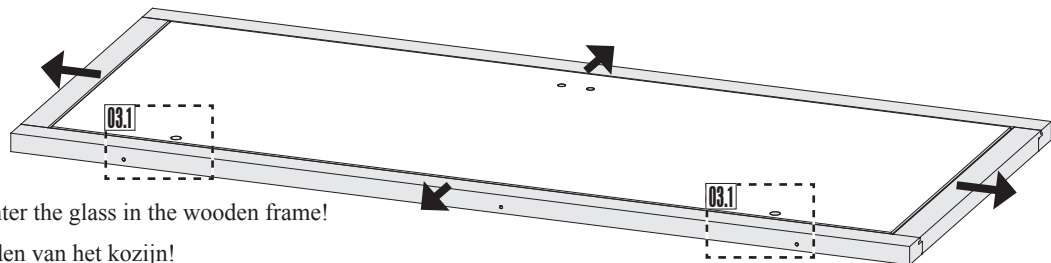

03.1-1

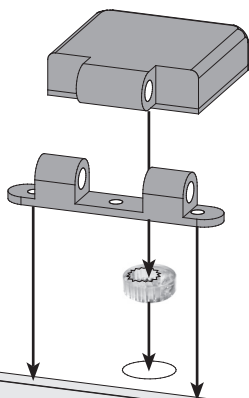

03.1-2

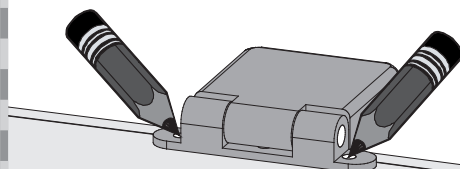

03.1-3

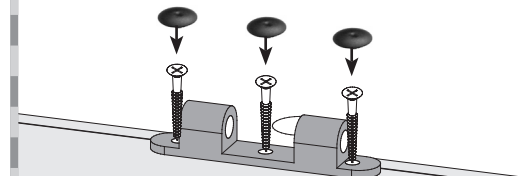

 Einbau Glastür

 Installation of glass door

 Montaje de la puerta de cristal

 Montage porte en verre

 Montage van de glazen deur

 Installazione portello di vetro

 Montáža steklenih vrat

04

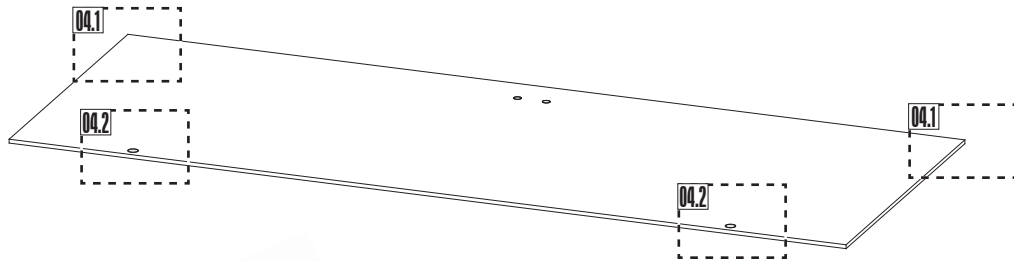

04.1-1

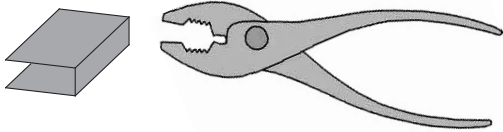

04.1-2

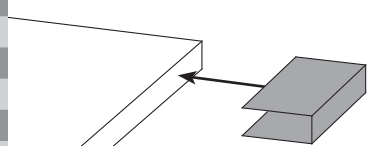

04.1-3

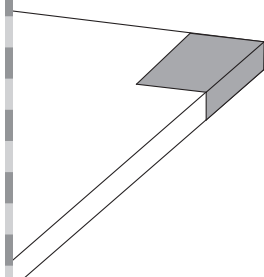

04.2-1

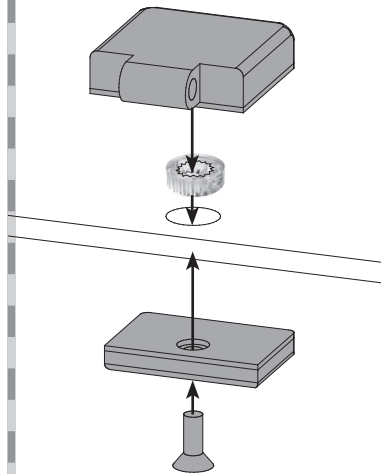

04.2-2

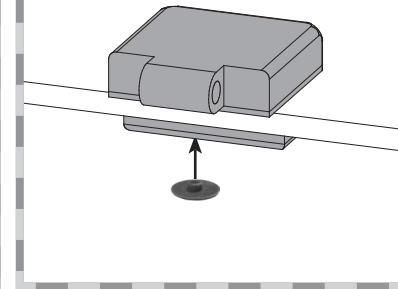

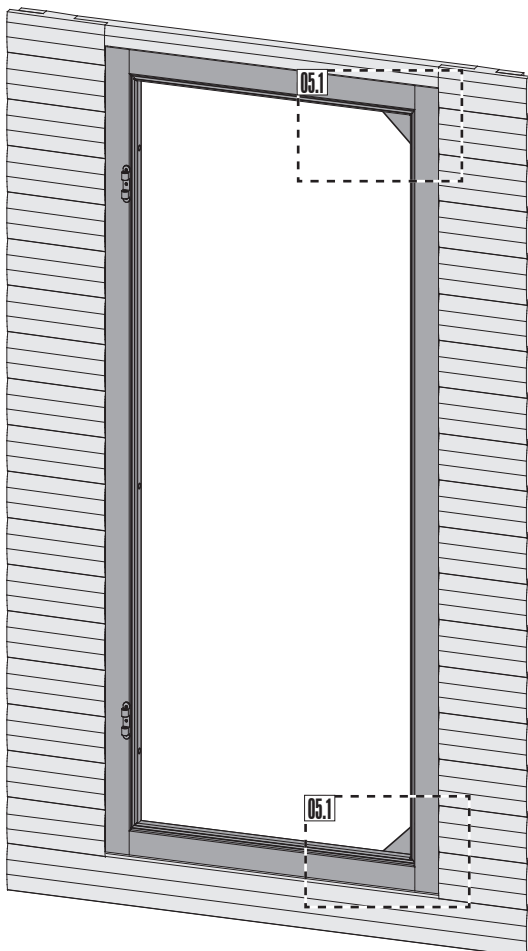

05





 Achtung: Alle Verstell-Excenter müssen in der Glasscheibe die gleiche Grundstellung haben!

 Attention: Tous les excentres de positionnement doivent avoir la même position de base dans la vitre!

 Attention: All adjustable eccentrics must have the same basic adjustment in the glass panel!

 Attentie: alle excentrische verstelelementen moeten in dezelfde stand in de glasplaat worden geplaatst!

 Atención: Todos los excéntricos regulables tienen que tener la misma posición base en la hoja de cristal.

 Attenzione: Tutti gli eccentrici di regolazione devono avere la stessa posizione base nella lastra di vetro!

 Pozor: vsi nastavljivi ekscentri morajo imeti v steklu enako osnovno nastavitvev!



05.1-1



05.1-2



 Einbau Glastür

 Installation of glass door

 Montaje de la puerta de cristal

 Montage porte en verre

 Montage van de glazen deur

 Installazione portello di vetro

 Montaža steklenih vrat

06

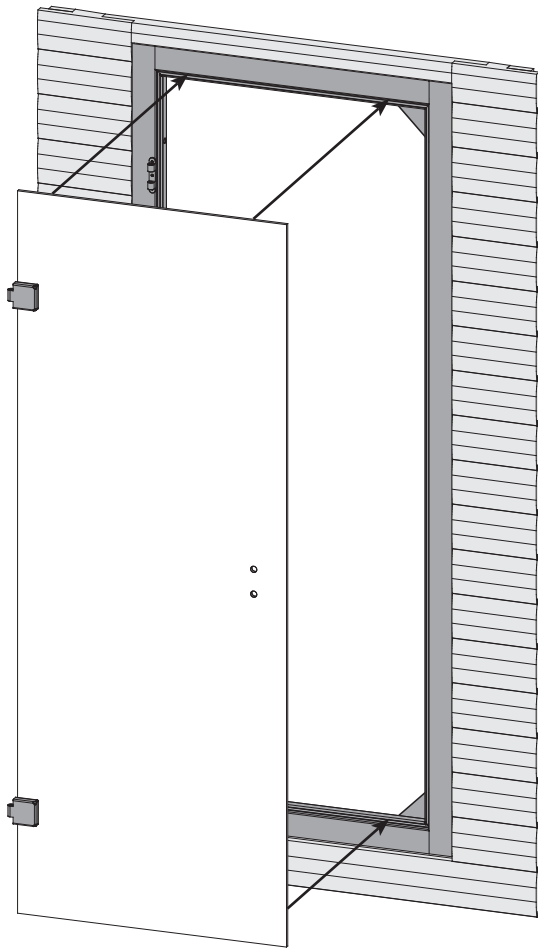

07

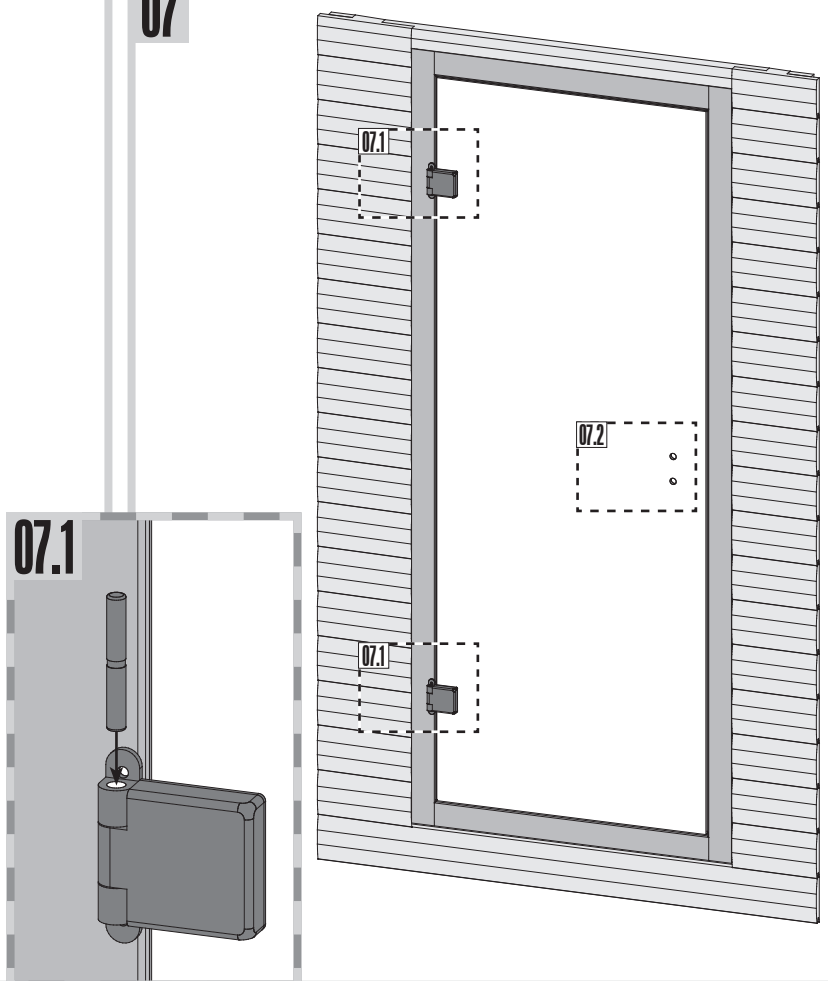

07.2-1

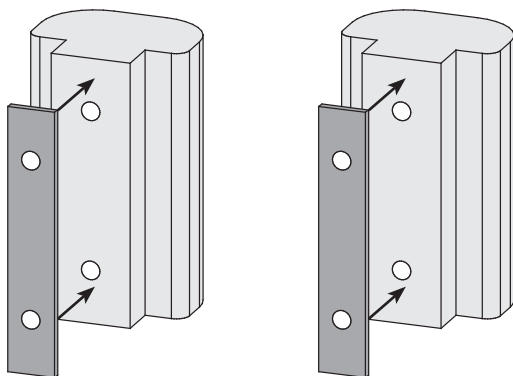

07.2-2

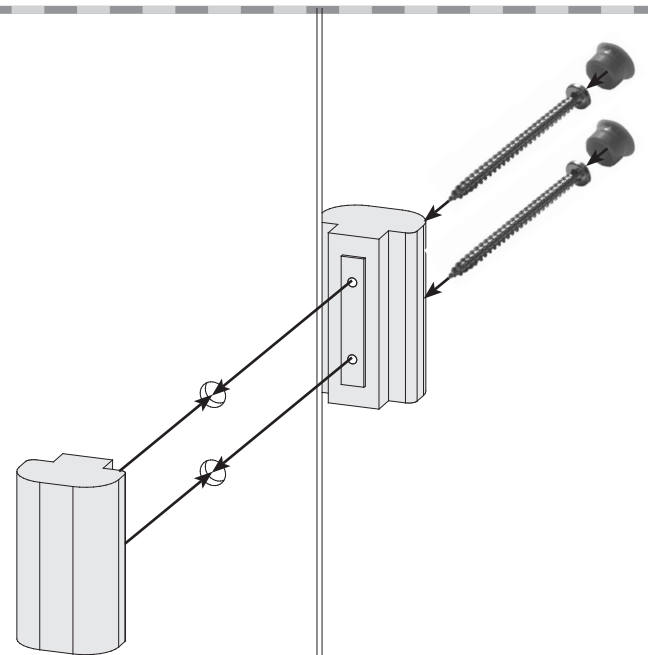

 **Einbau Glastür**

 **Installation of glass door**

 **Montaje de la puerta de cristal**

 **Montage porte en verre**

 **Montage van de glazen deur**

 **Installazione portello di vetro**

 **Montaža steklenih vrat**

08

 **Seitenverstellung + Höhenverstellung**

Achtung: Alle Verstell-Excenter müssen in der Glasscheibe die gleiche Grundstellung haben!

 **Positionnement latéral + positionnement hauteur**

Attention: Tous les excentres de positionnement doivent avoir la même position de base dans la vitre!

 **Lateral adjustment + height adjustment**

Attention: All adjustable eccentrics must have the same basic adjustment in the glass panel!

 **Zijverstelling + hoogteverstelling**

Attentie: alle excentrische verstelelementen moeten in dezelfde stand in de glasplaat worden geplaatst!

 **Regulación lateral + regulación de la altura**

Atención: Todos los excéntricos regulables tienen que tener la misma posición base en la hoja de cristal.

 **Regolazione laterale + regolazione dell'altezza**

Attenzione: Tutti gli eccentrici di regolazione devono avere la stessa posizione base nella lastra di vetro!

 **Stranska nastavitvev + višinska nastavitvev**

Pozor: vsi nastavljeni ekscentri morajo imeti v steklu enako osnovno nastavitvev!

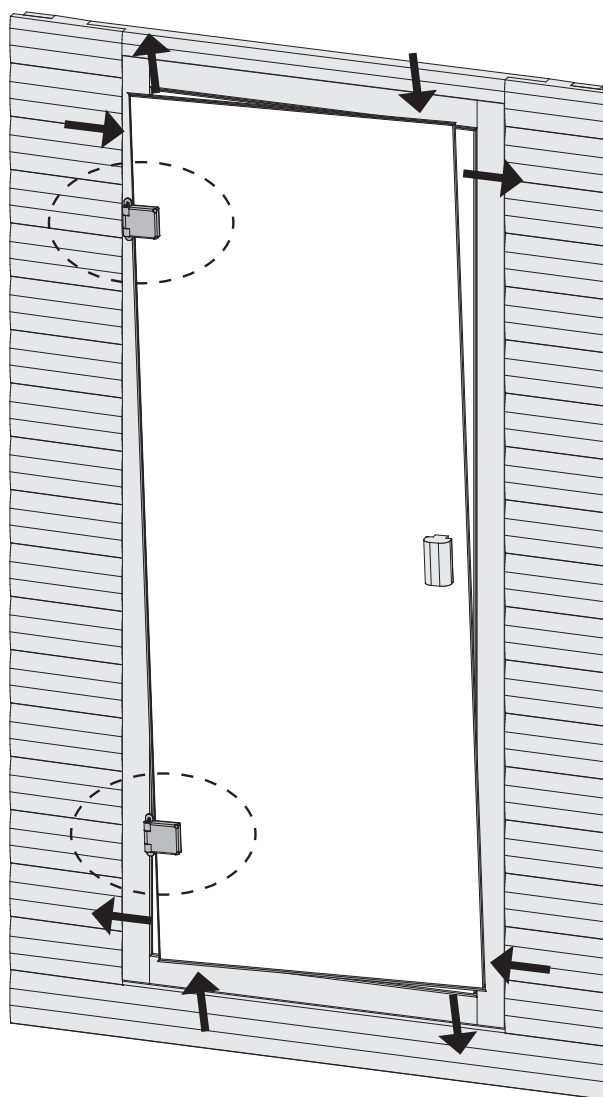
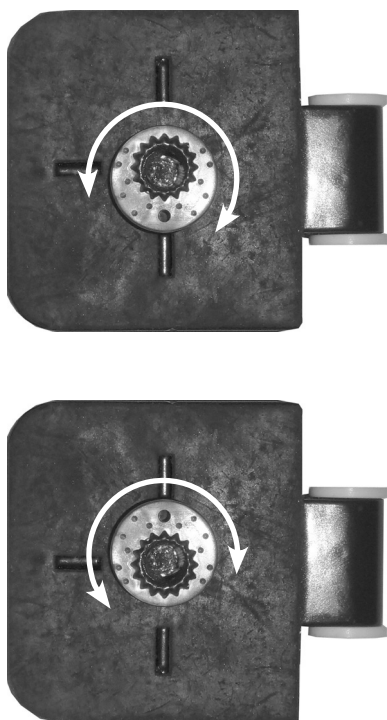

01

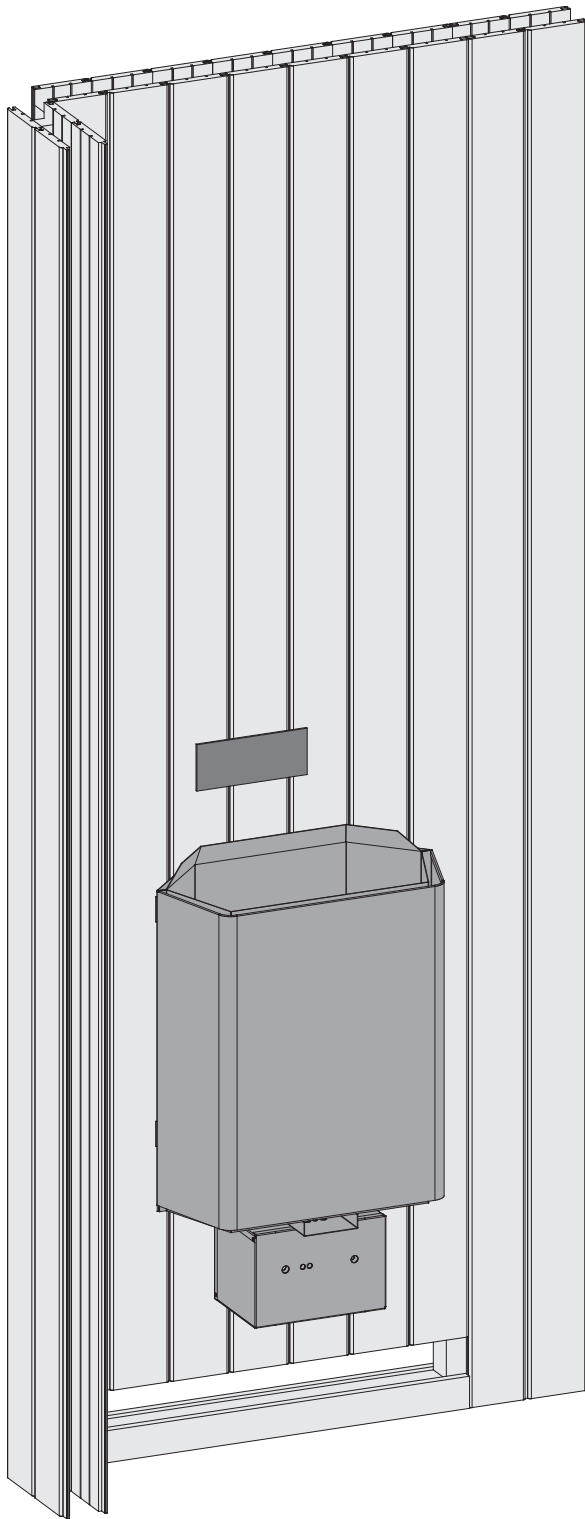

02

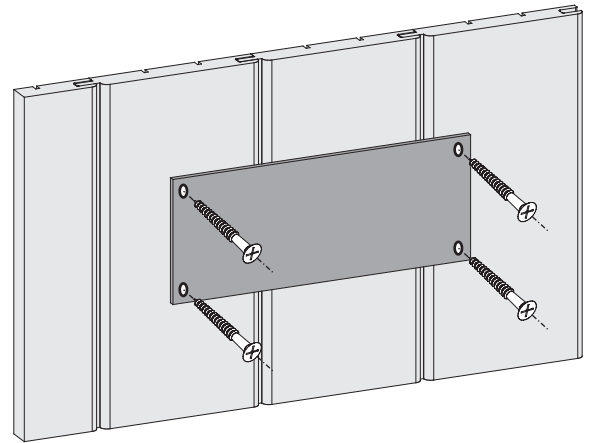

Entfernen Sie die Schutzfolie vom beiliegenden TÜV-Schild.

Lassen Sie den Saunaofen von einem zugelassenen Elektrofachmann anschließen. Dieser markiert den installierten Ofen auf dem TÜV-Schild.

Bringen Sie das TÜV-Schild an einer gut sichtbaren Stelle über dem Ofen an.

Odstranite zaščitno folijo na znaku.

Peč v savni naj priključi strokovnjak za elektriko.

Ta označi nameščeno peč na TÜV znaku. TÜV znak namestite na dobro vidno mesto nad pečjo.

