

Techn. Daten Aruba

Log length (W x D) / Bohlenaußenmaß (B x T): 350 x 350 cm

Wall size(outside) / Wandaußenmaß: 330 x 330 cm

Log thickness / Bohlenstärke: 40 mm

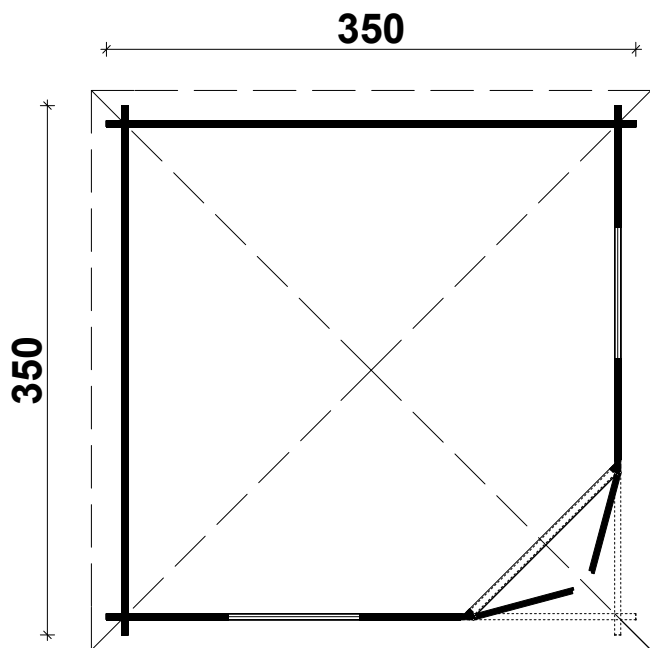

Note: All dimensions are approximate ! / Achtung : Alle angegebenen Maße sind ca. - Maße !

Aruba 350 x 350 cm

Foundation / Fundament

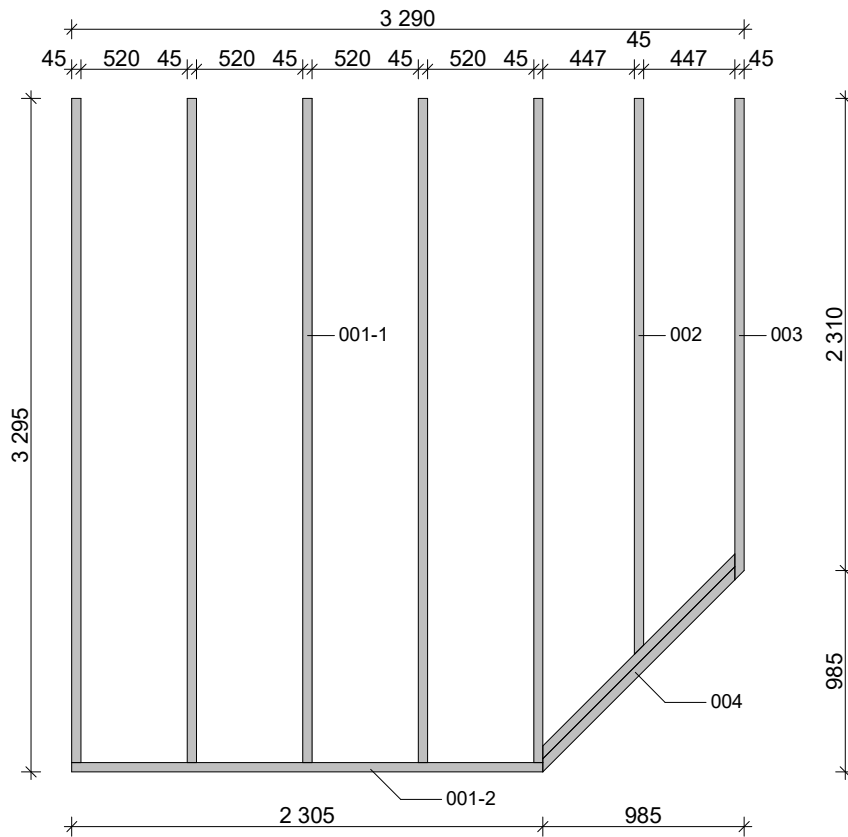

Groundplan / Wandplan

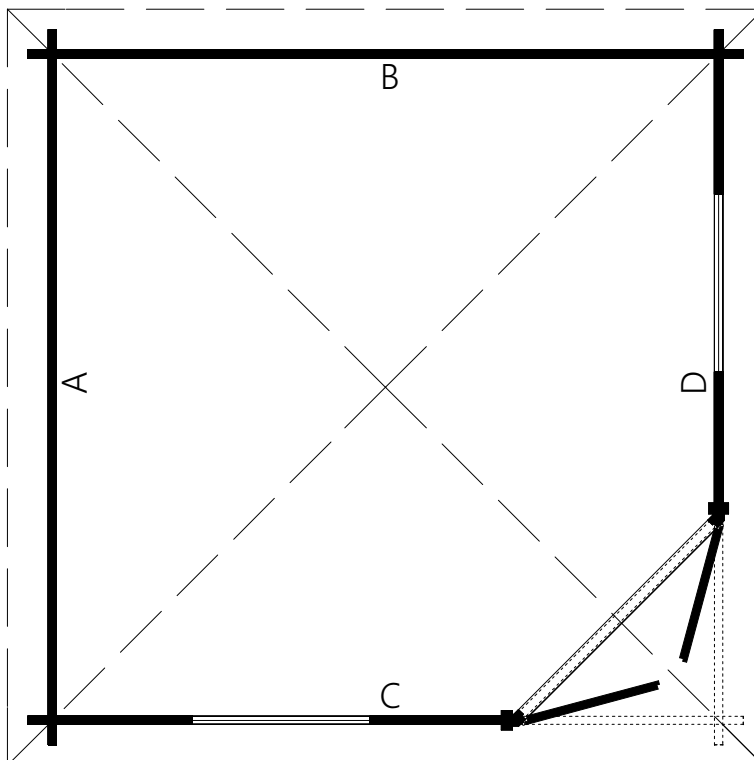

Aruba 350x350cm

A

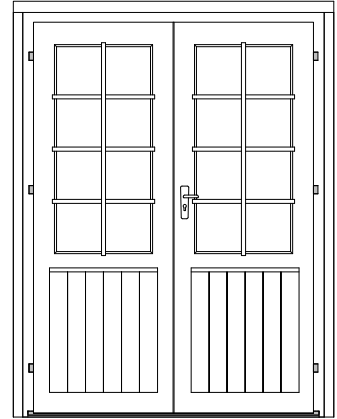
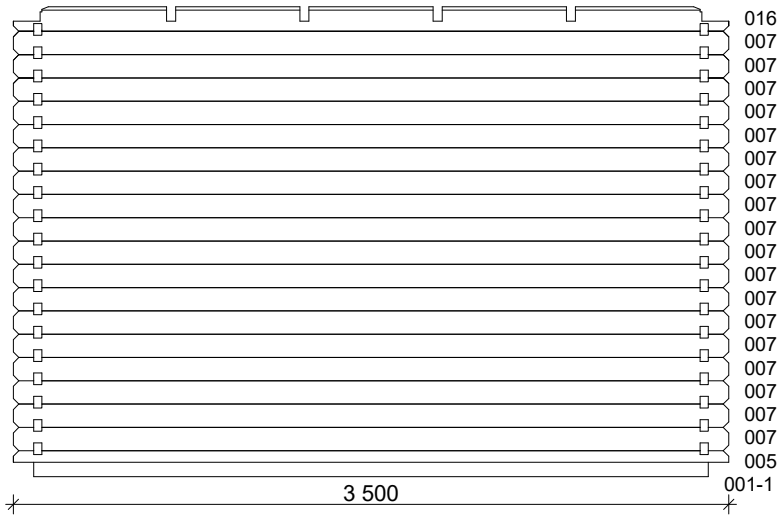

Double door / Doppeltür
1425 x 1900 mm
1 stk

B

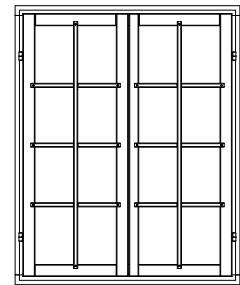
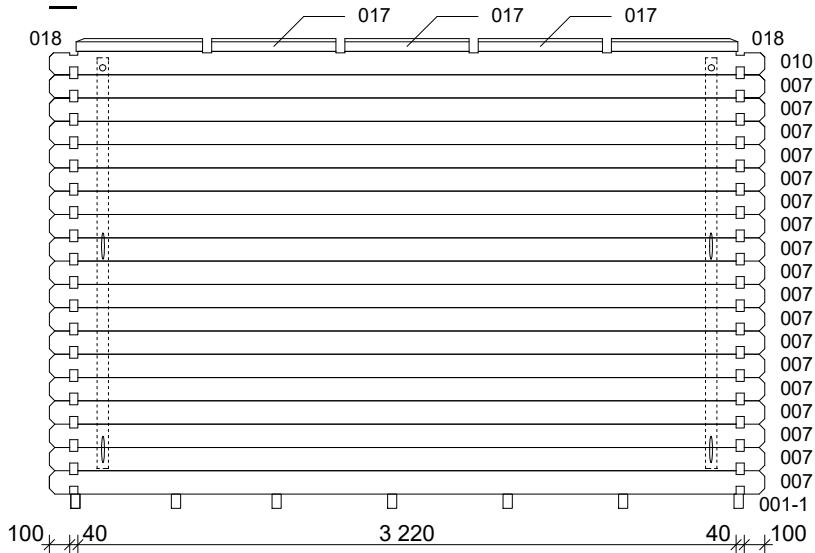

Window / Einzelfenster
40 mm
1100 x 1365 mm
2 stk

C

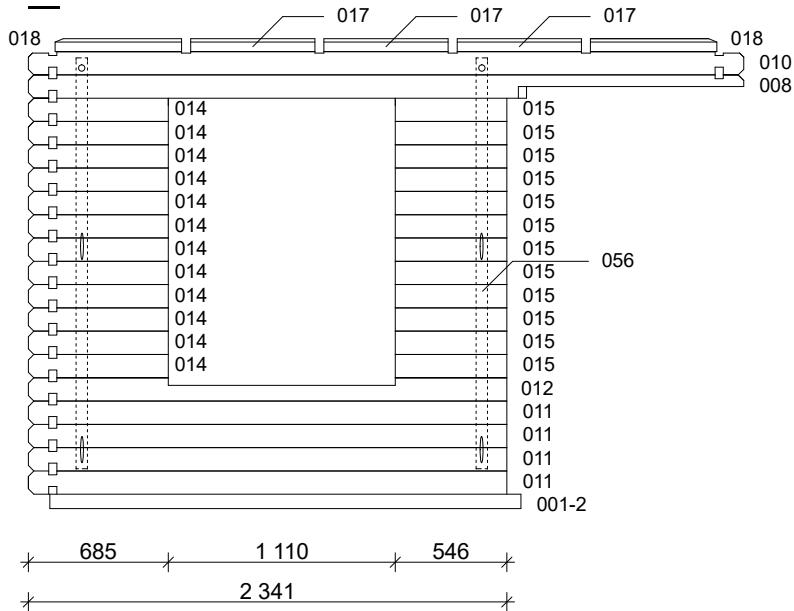

685 1 110 546

2 341

Aruba 350x350cm



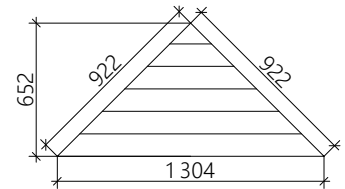
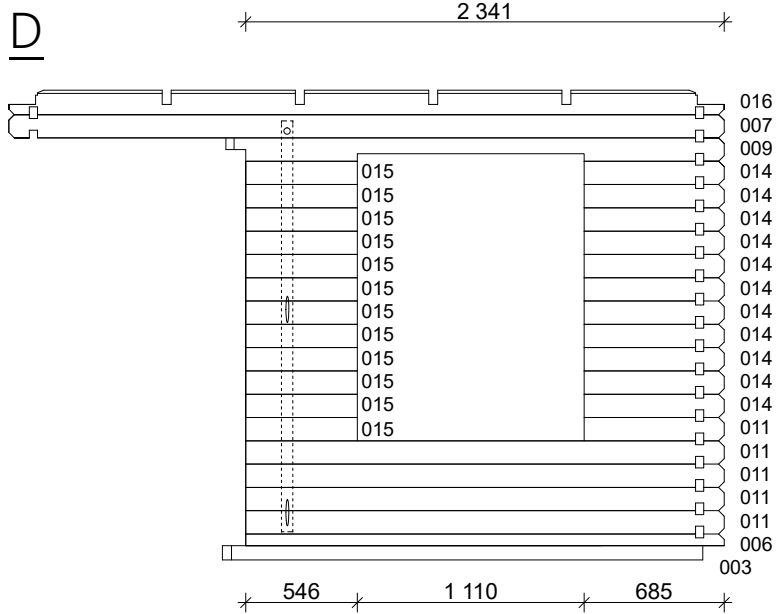



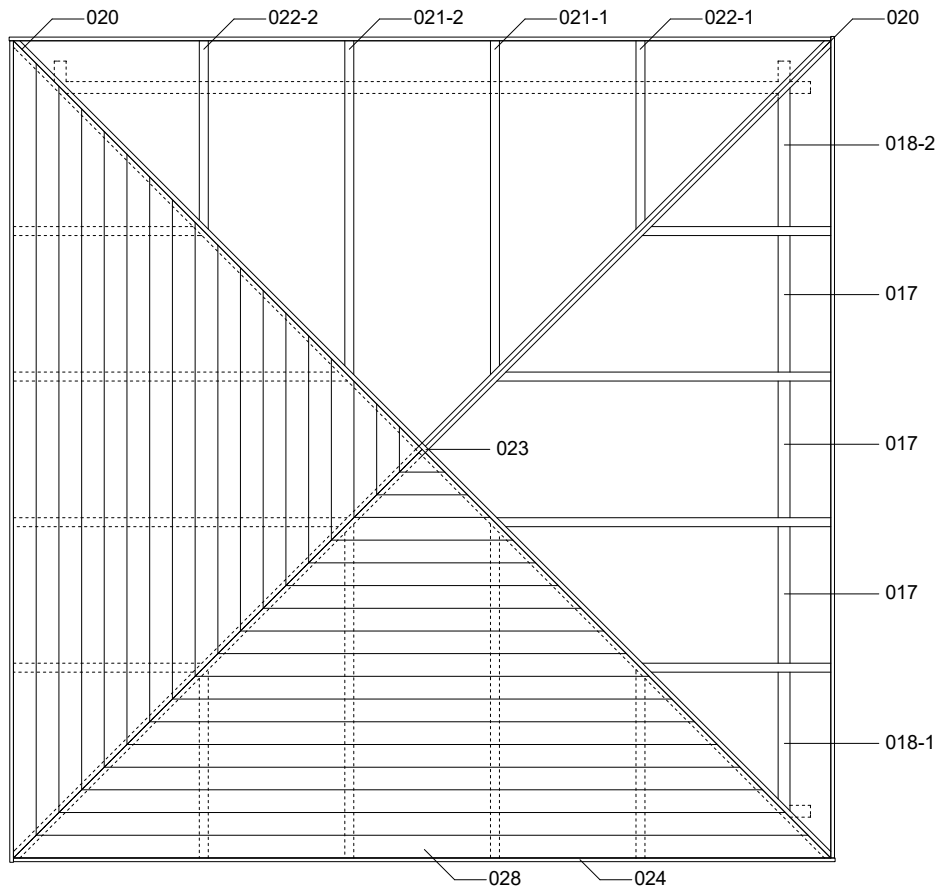









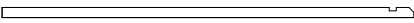

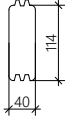

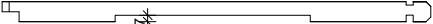
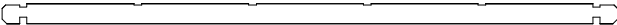

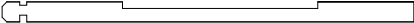

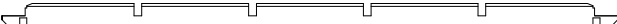

Roof elements / Dachelemente



Roof plan / Dachplan

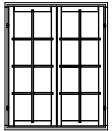





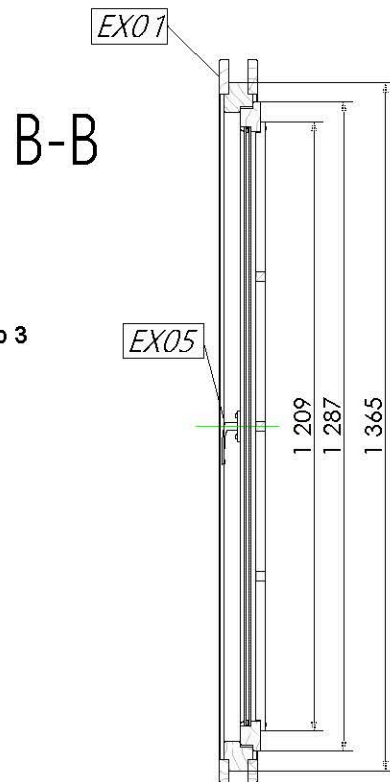
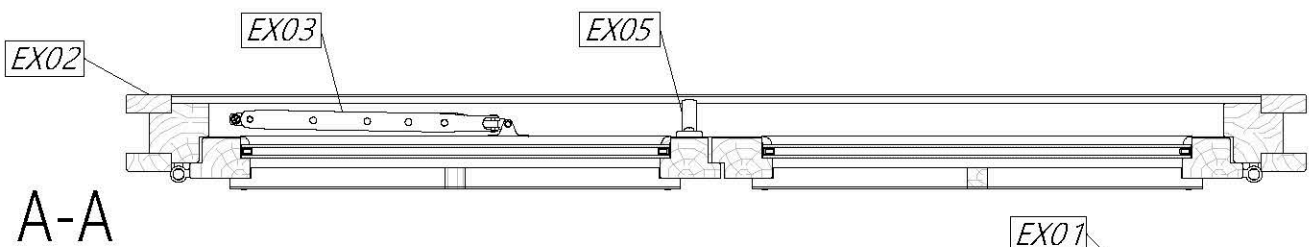
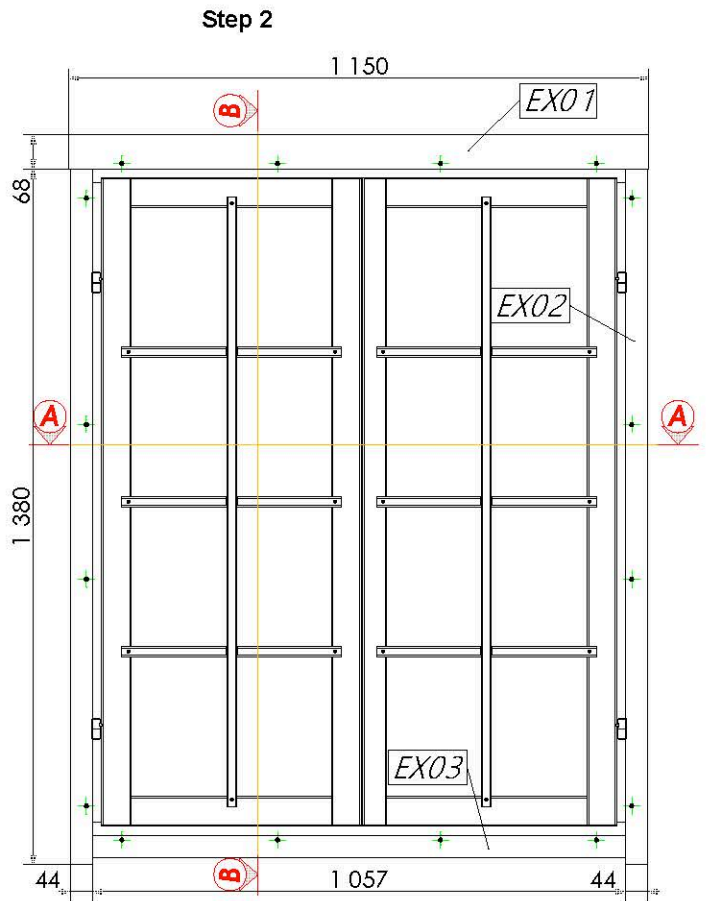
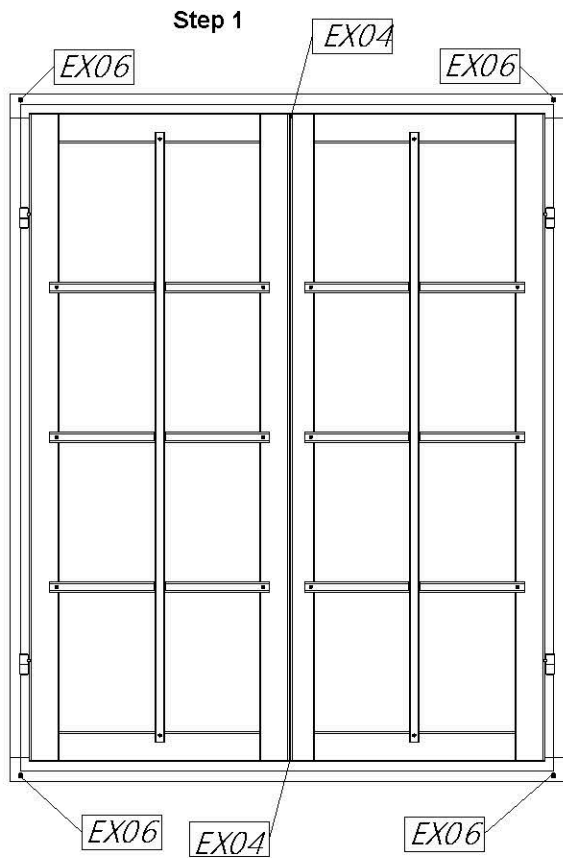

Teileliste Aruba 350x350cm

Nr.		 mm	 mm	 x
1	Foundation beams / Fundamenthölzer	45x70	3250/2305	5/1
2			2720	1
3			2355	1
4			1374	2
5			3500	1
6			2341	1
7			3500	37
8			3500	1
9			2438	1
10			3500	2
11			2341	8
12			2341	1
13			--	--
14			685	24
15			546	24
16				3500
17		608		6
18			619	4(2+2)
19			1384	1
20	Roof beams / Dachbalken	44x94	2725	4
21	Roof beams / Dachbalken	44x85	1668	8(4+4)
22	Roof beams / Dachbalken		965	8(4+4)
23	Central connecting wood / Zentral-Verbindungs-Holz			1
24	Eave edging / Traufenbrett	18x115	3750	4
25	Double door / Doppeltür 1425 x 1900 mm / 40 mm - R Standart +			1
26	Double window / Doppelfenster 1100 x 1365 mm / 40 mm Standart +			2
27	Roof elements / Dachelemente h= 652 mm		1304 x 922	1
28	Roof boards / Dachbretter		3694	4
29			3490	4
30			3286	4
31			3082	4
32			2878	4



Catania / Aruba / Sicilia / 1100 x 1365 mm Stand +/- 40 mm - R

Nr.	Description	Profile mm	Length mm	Quantity
EX01	Exterior- and interior trim	 18x68	1150	2
EX02		 18x44	1380	4
EX03			1057	2
EX04		 14 x 26		2
EX05	Handle			1
EX06	Screws 4,0 x 40			36+2
EX06	Window Clamp			1

Doppeltür (Wand 40 mm)

Nr	Beschreibung	Profil mm	Stück
1	Rahmen profil Links + Rechts	99 x 82	1+1
2	Rahmen profil Oberteil	58 x 58	1
3	Türschwelle	28 x 58	1
4	Wechselrahmen	28 x 55	2
5			2
6		28 x 70	1
7			1
8			2(1+1)
9			2(1+1)
10	Edelstahlbedeckung für Türschwelle		1

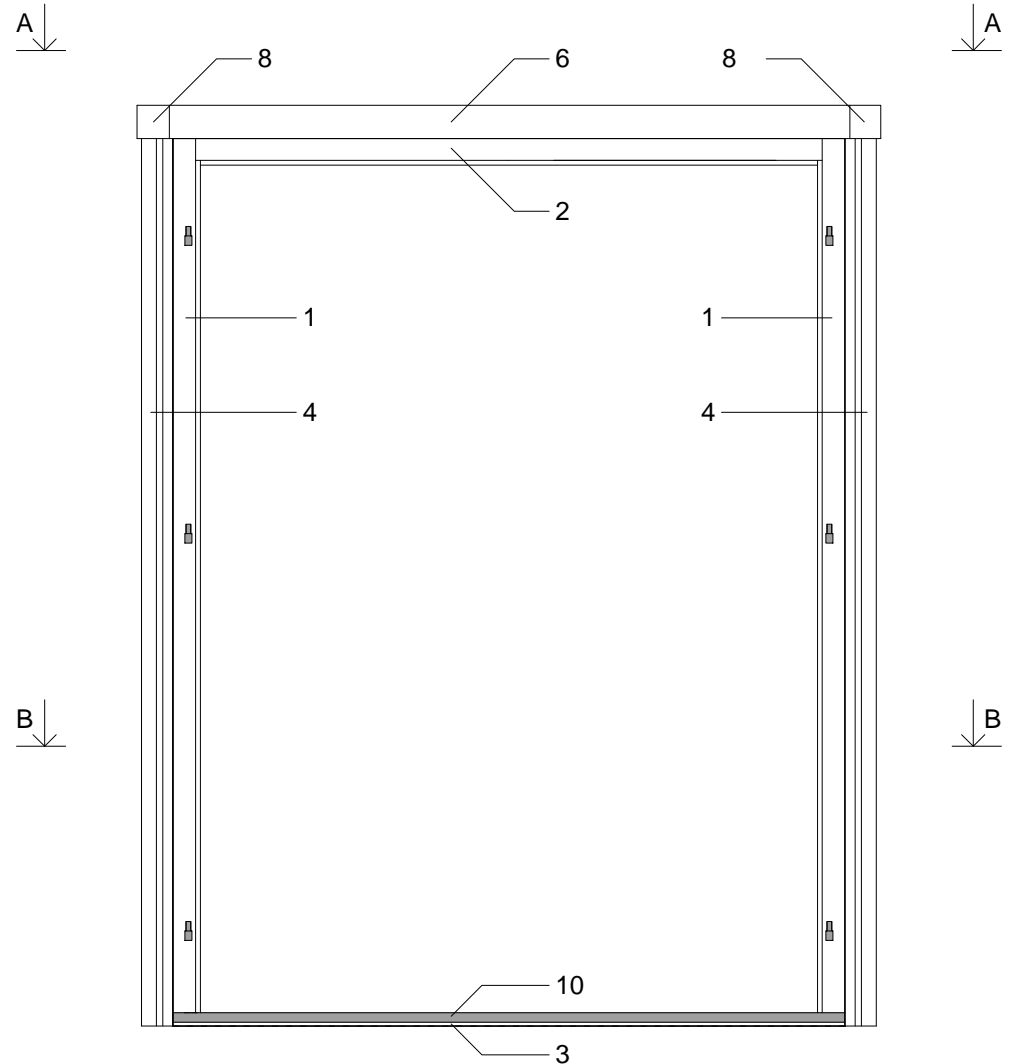

A-A

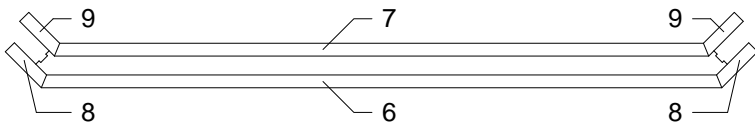

B-B

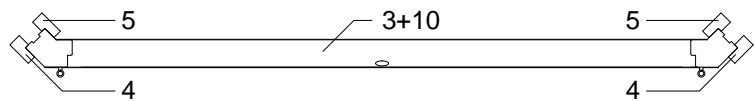

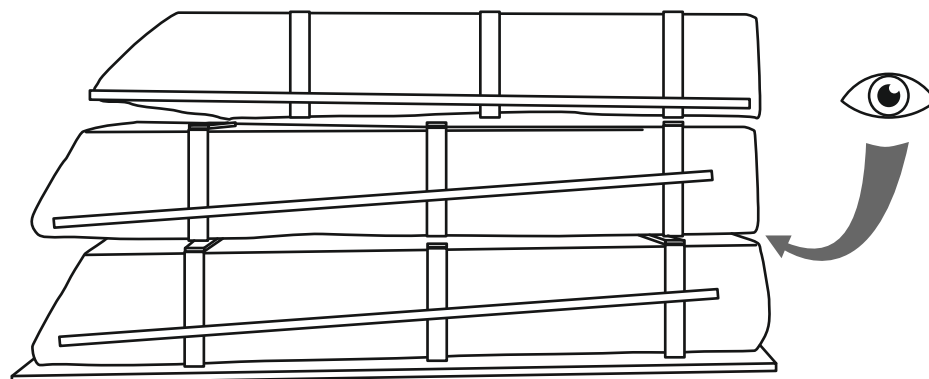
1

- EE** Sõltuvalt tellitud mudelist asuvad immutatud vundamendiprussid ja terrassilauad TENE pakkimiskile all.
- ENG** Depending on the model ordered it may include impregnated foundation beams and terrace boards, these are packed at the bottom of the package.
- DE** Je nach bestelltem Modell sind die imprägnierte Fundamentbalken und Terrassenbretter unter TENE-Verpackungsfolie zu finden.
- ES** Según modelo, los rastreles del suelo y las tablas de la terraza tratadas en autoclave verde, se sitúan en la parte inferior del paquete, debajo de plástico de embalaje con logotipo Tene.
- IT** In base al modello ordinato, le travi impregnate da pavimento e i pannelli di rivestimento si trovano sotto la pellicola d'imballaggio TENE.
- FR** Selon le modèle dans votre commande, les poutres de fondement imprégnées et les lames de terrasse se trouvent sous le film de conditionnement TENE.

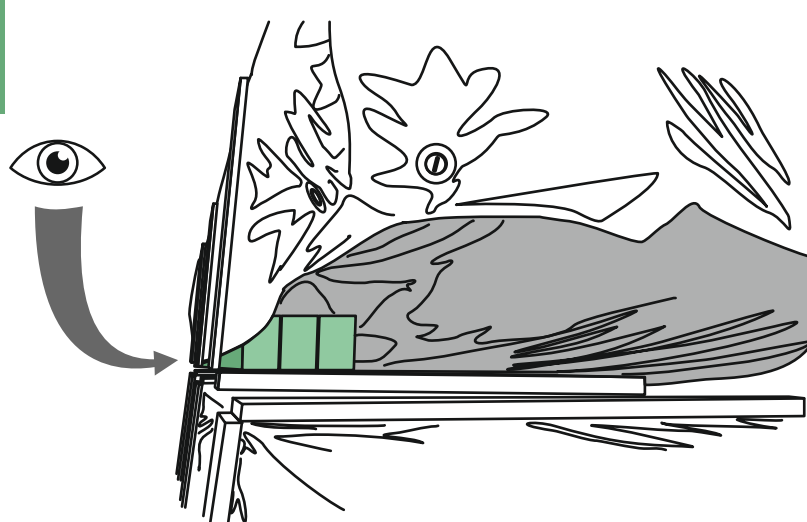
2

- EE** Vaata pakkimiskile alla, et leida puuduolevad maja osad!
- ENG** Please look at the bottom of the packaging to find these house parts.
- DE** Schauen Sie bitte unter Verpackungsfolie nach, um die fehlenden Teile herauszufinden!
- ES** Mira por debajo del plástico con logotipo de Tene, encontrarás las piezas que te faltan. Las reconocerás por su tono verdoso.
- IT** Controlla sotto la pellicola d'imballaggio per trovare le altre parti della casa!
- FR** Regarde sous le film de conditionnement pour trouver les détails manquants de la maison!

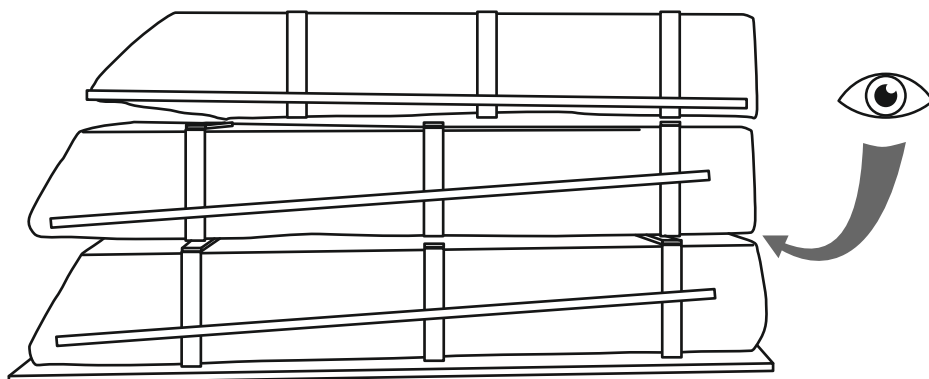
1

PL W zależności od zamówionego modelu impregnowane belki fundamentowe i deski tarasowe są umieszczone pod foliowym opakowaniem TENE.

FI Kyllästetyt pohjapalkit ja terrasilaudat sijaitsevat tilauksesta riippuen TENE-pakkauskalvon alla.

SE Beroende på beställd modell förpackas impregnerade sylldelar och terrassbrädor i TENEs emballageplast.

DA Afhængigt af hvilken model, der er bestilt, befinder de trykimprægnerede fundamentsstrøer og terrassebrædder sig under TENE's emballageplast.

RU В зависимости от заказанной модели пропитанный фундаментный брус и террасная доска TENE находятся под упаковочной пленкой.

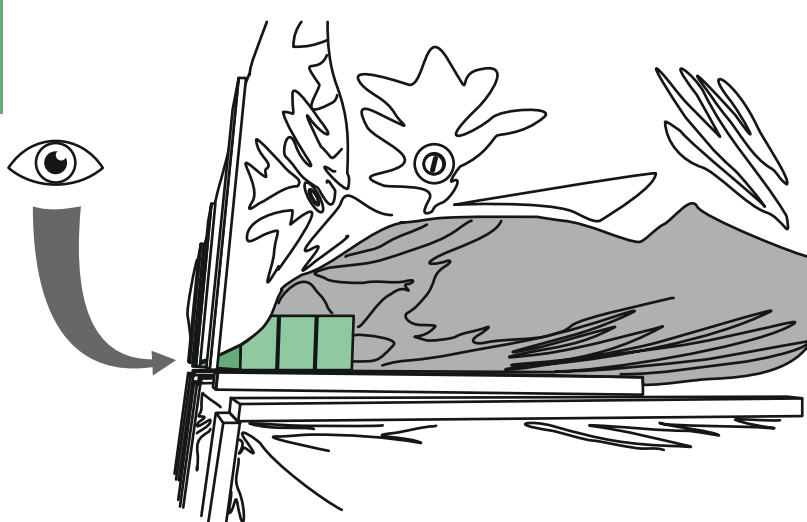
2

PL Zjrzyj pod foliowe opakowanie, aby znaleźć brakujące elementy domu!

FI Puuttuvat talon osat löytyvät pakkauskalvon alta!

SE Titta under emballageplasten för att hitta saknade husdelar!

DA Se under emballageplasten for at finde manglende dele til huset.

RU Посмотрите под упаковочную пленку, чтобы найти недостающие части дома!