

*Orkney 5*  
*Art.No. 704641*

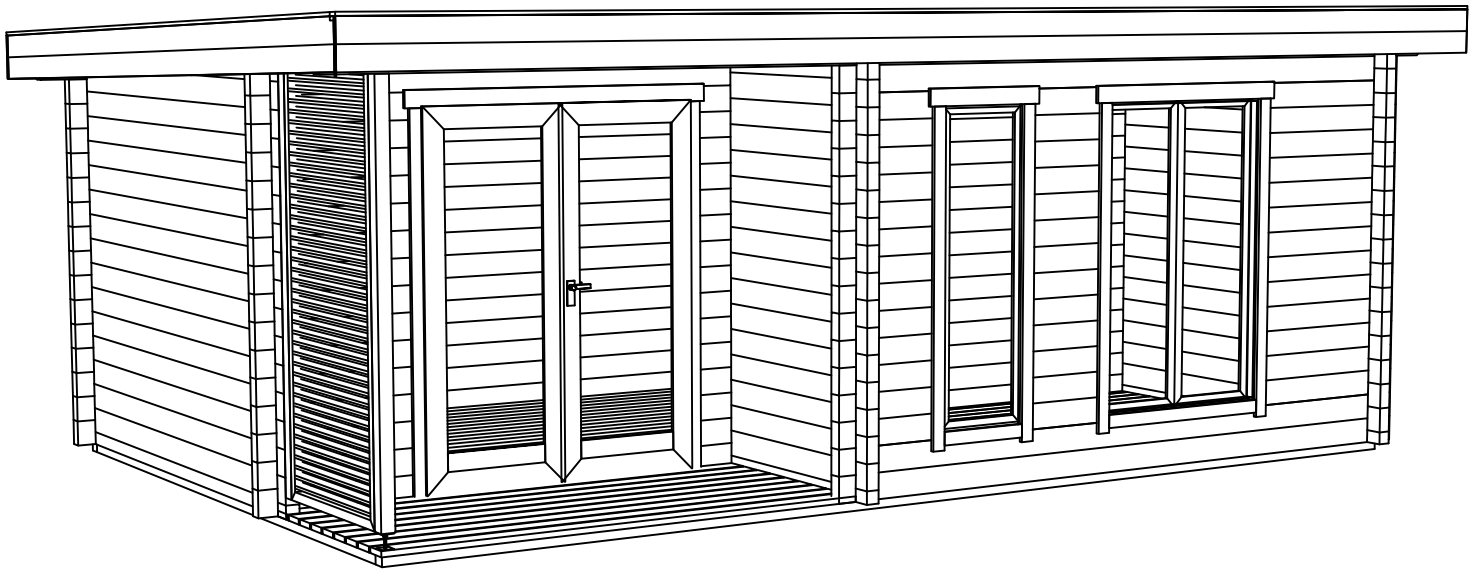

ORKNEY 5, Art.No.704641

Groundplan - Grundplan - Plan de masse - Planimetria - Plattegrond - Põhiplan

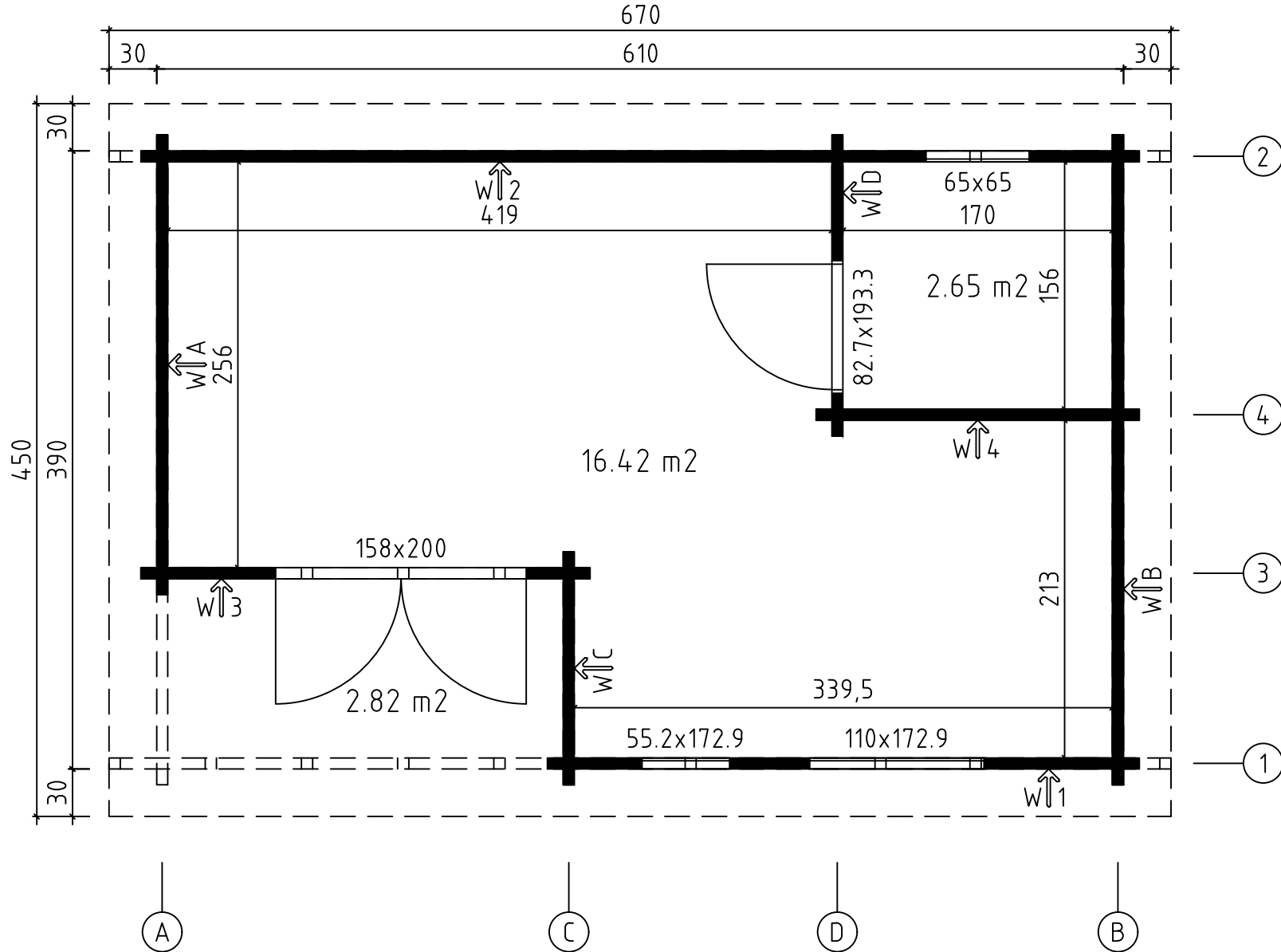

ORKNEY 5, Art.No.704641

Foundation - Fundament - Fondation - Fondamenta - Fundering - Immutatud alusraam

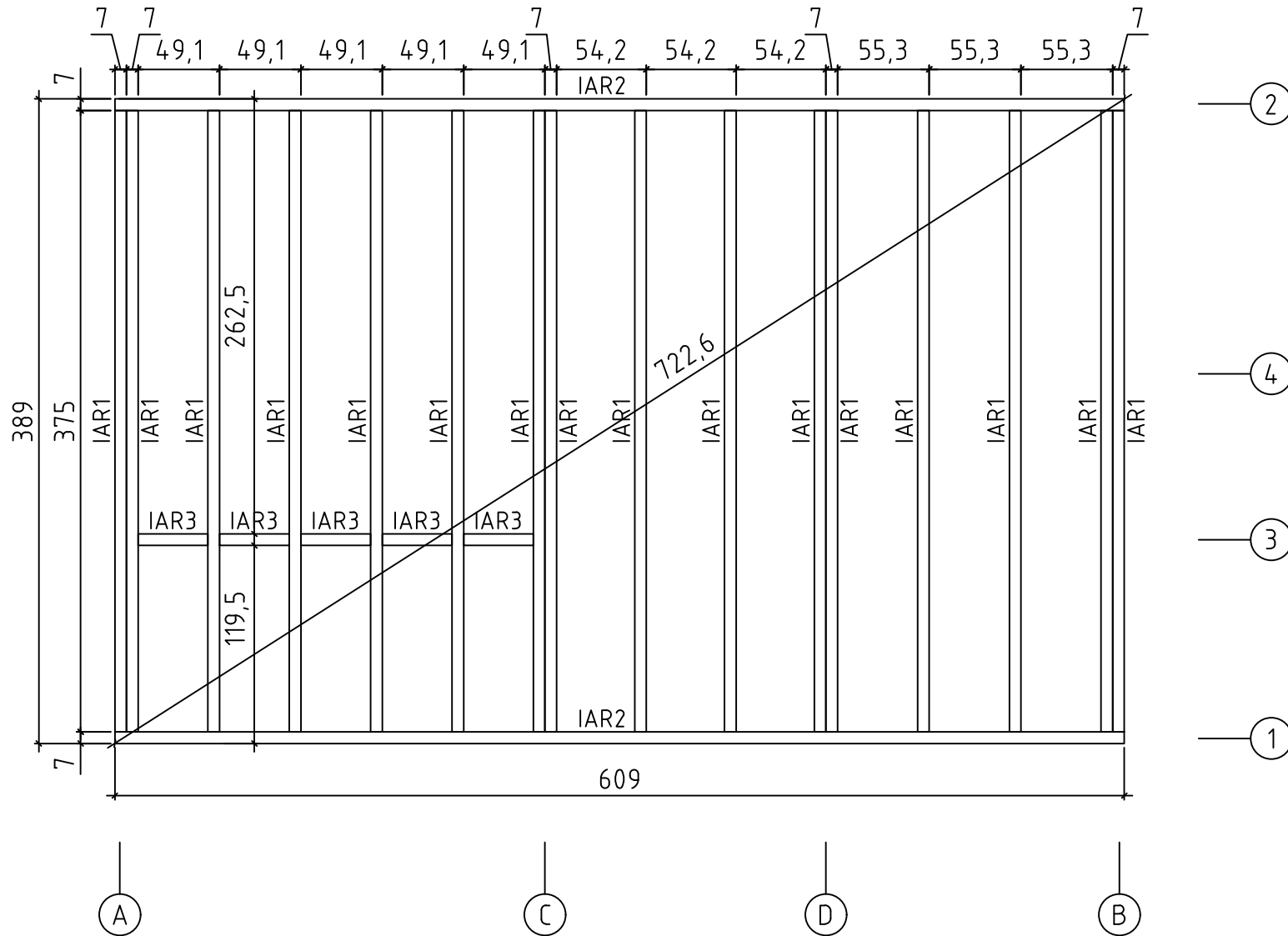

ORKNEY 5, Art.No.704641

Rafters plan - Dachsparren - Plan de chevron - Piano di travi - Dak spar constructie plattegrond - Sarikaplaan

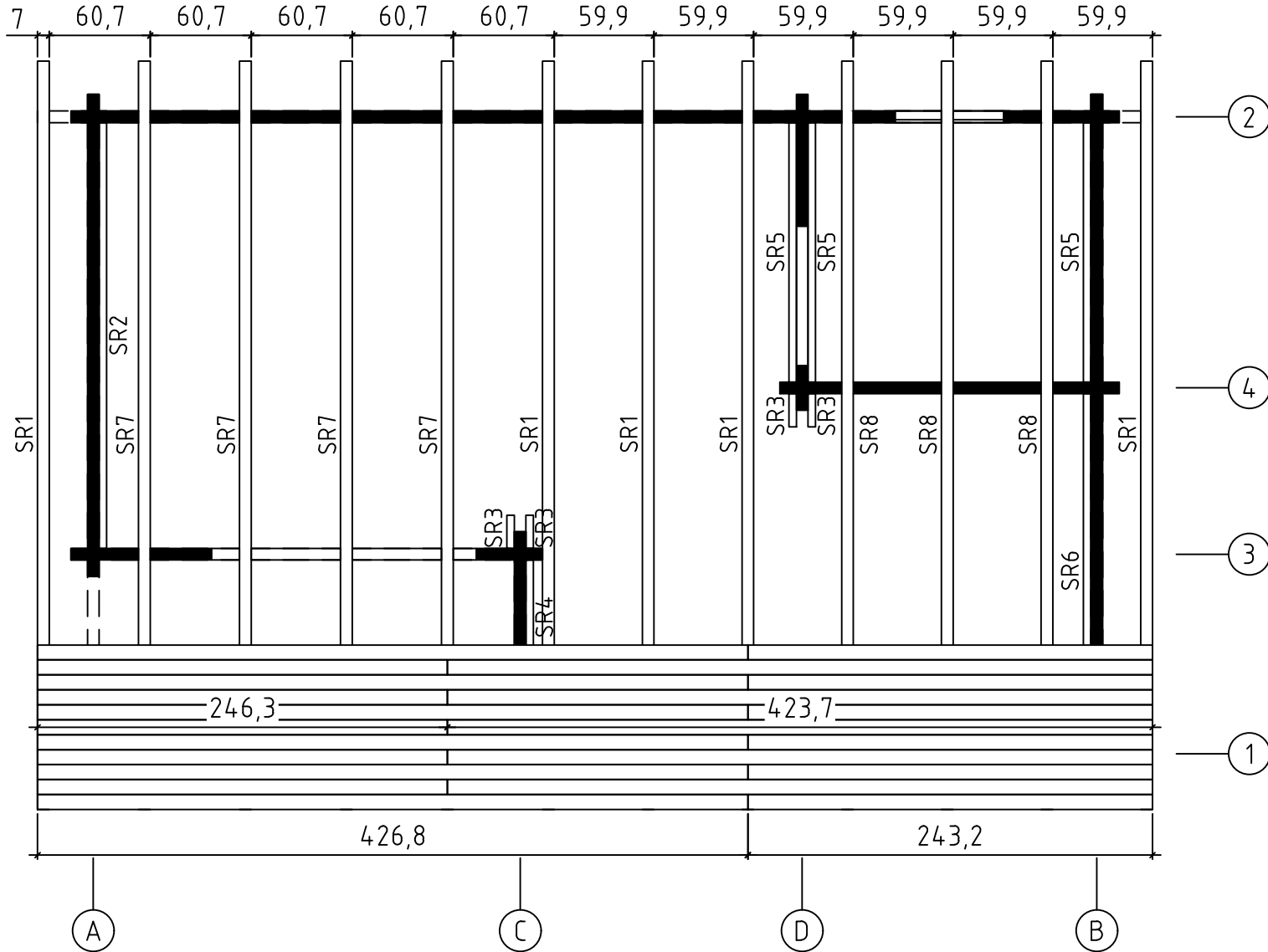

ORKNEY 5, Art.No.704641

Floor boards - Fussbodenbretter - Plan pose plancher - Pavimento - Vloerhout - Põrandalaudis  
Terrace boards - Terrassenbretter - Plancher de terrasse - Piattaforme terrazzo - Terrasvloer -  
Terrassilaudis



ORKNEY 5, Art.No.704641

Ceiling boards - Deckenbrett - Voliges sous plafond - Tavole per piano soffitto - Dakhout - Laelaud

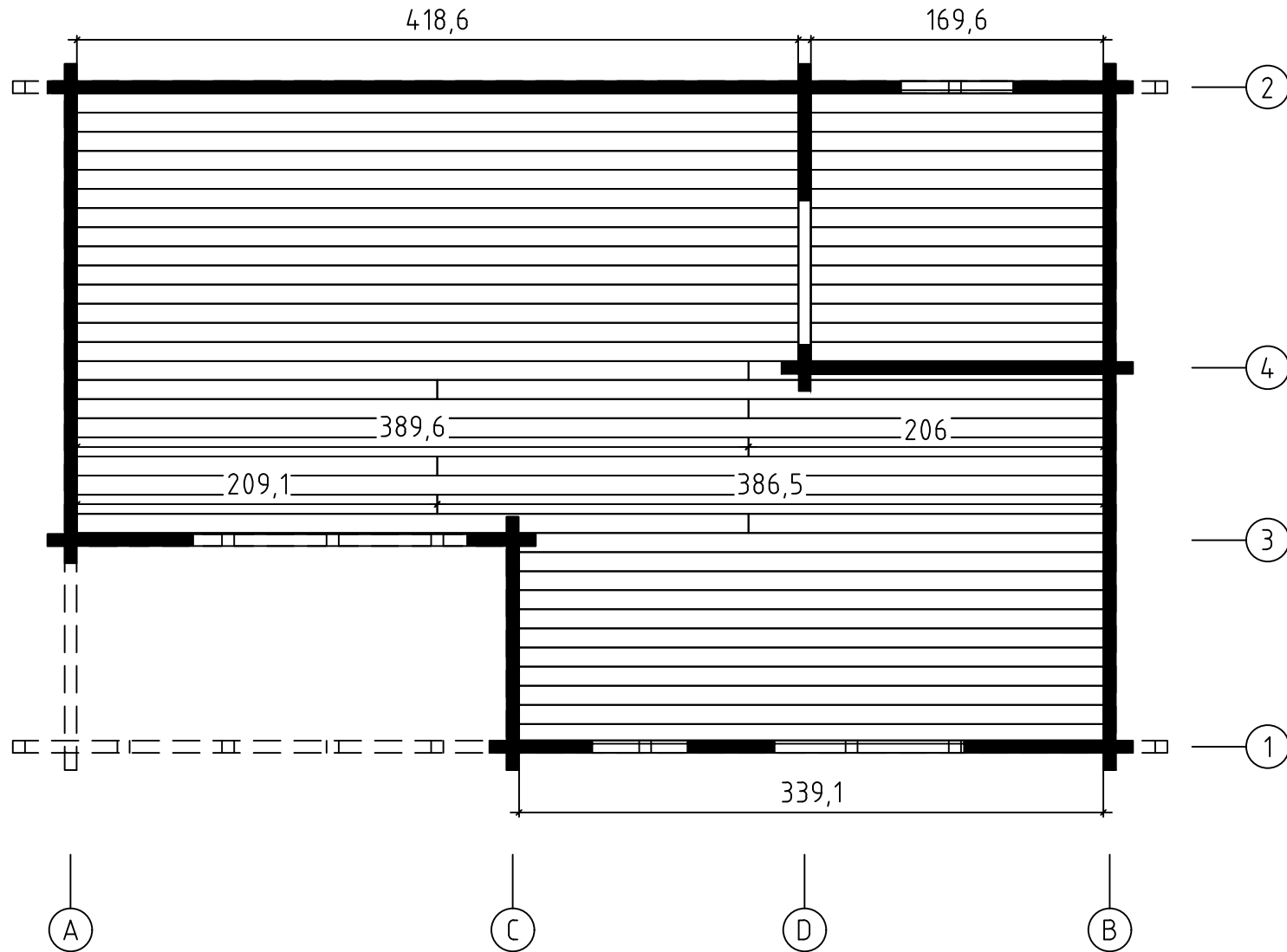

ORKNEY 5, Art.No.704641

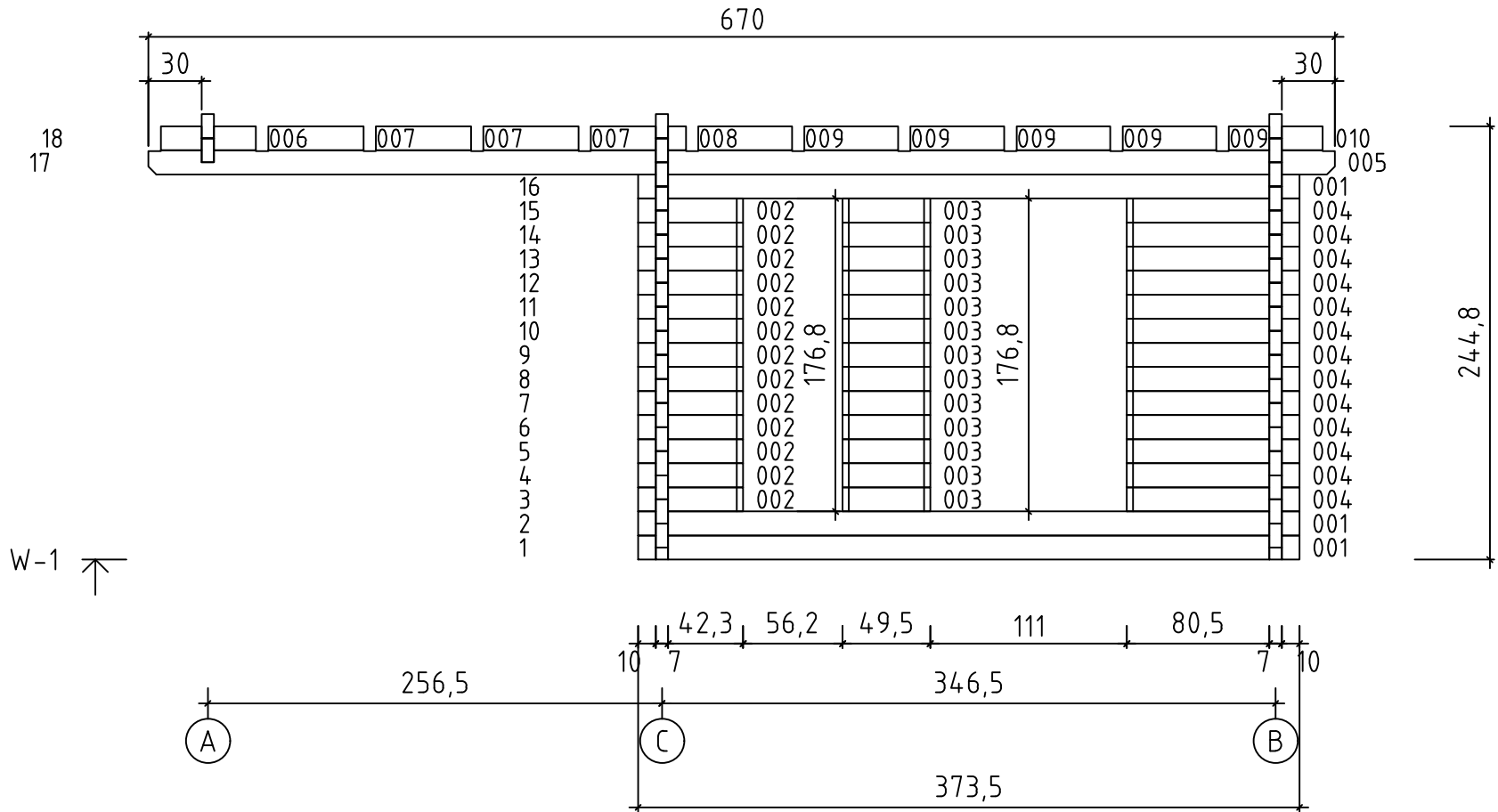

ORKNEY 5, Art.No.704641

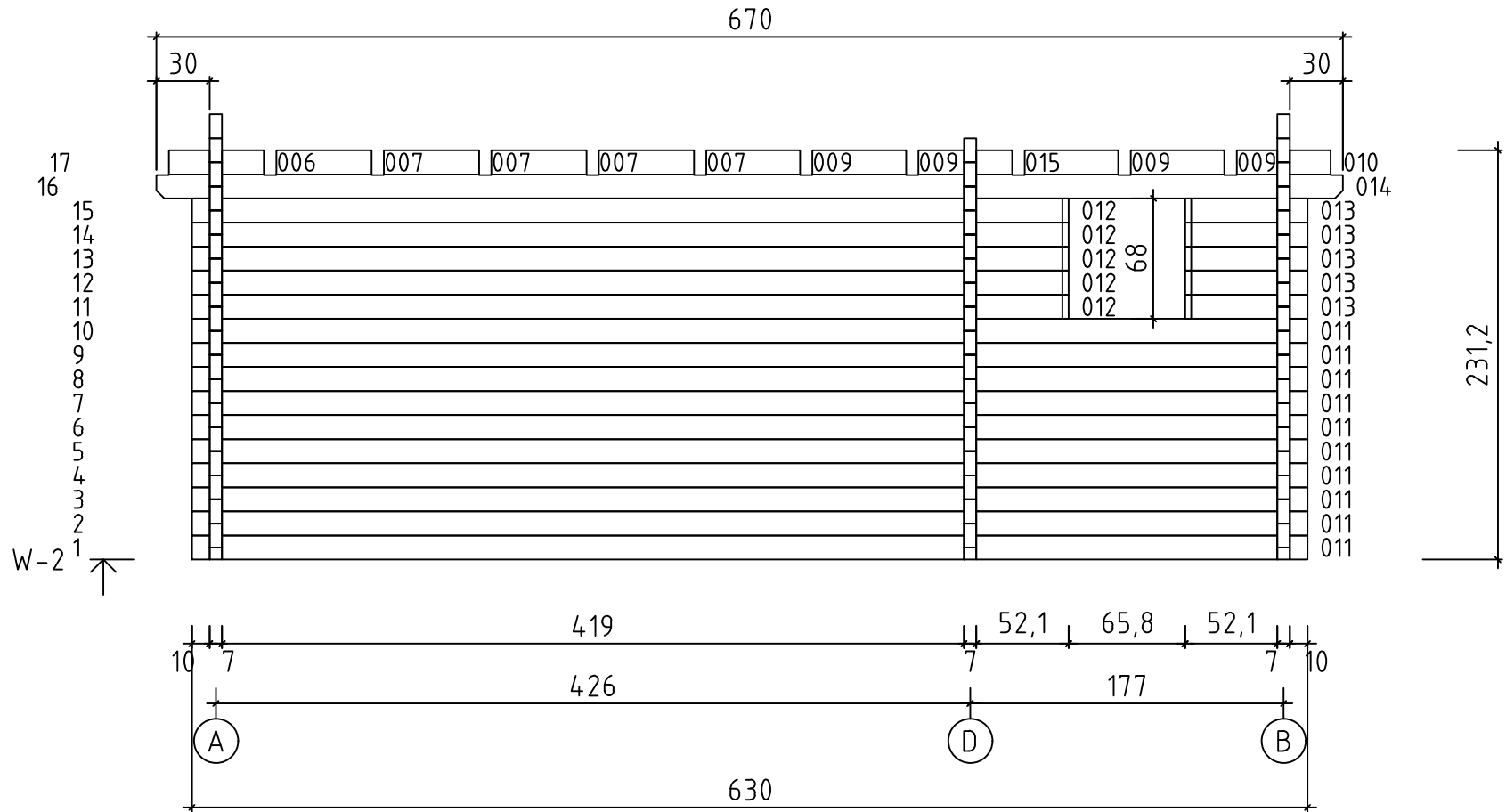



ORKNEY 5, Art.No.704641

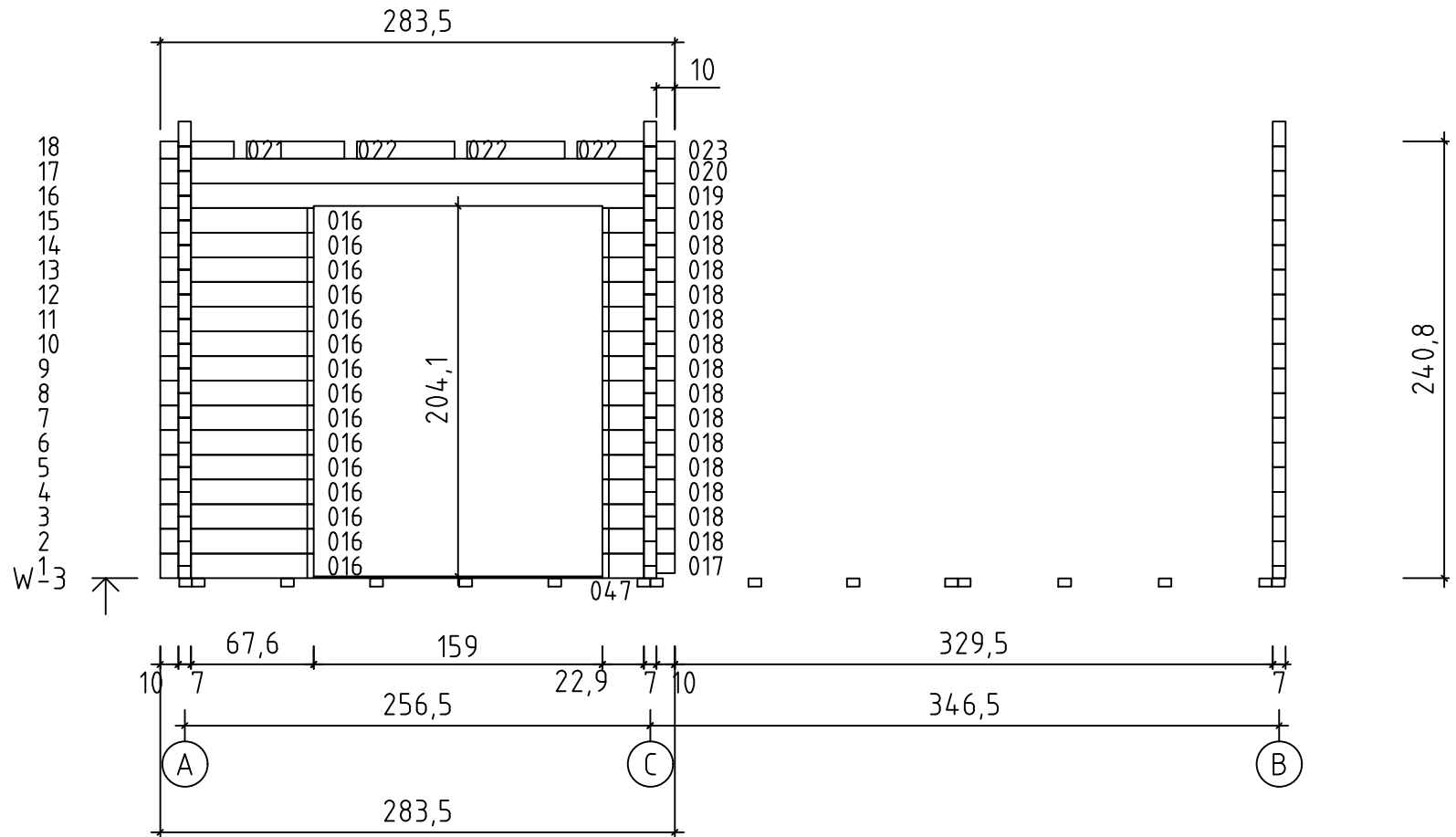



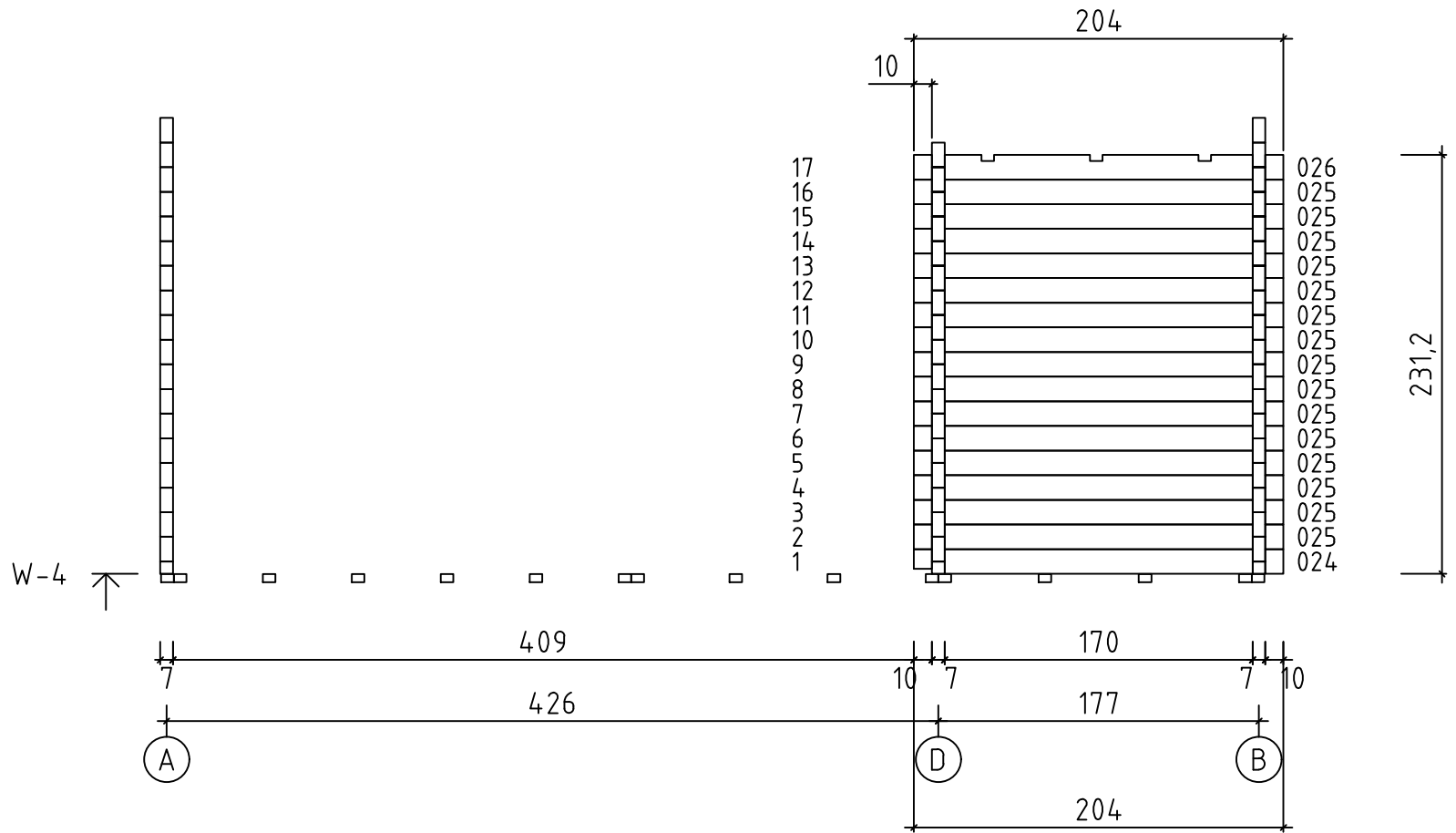

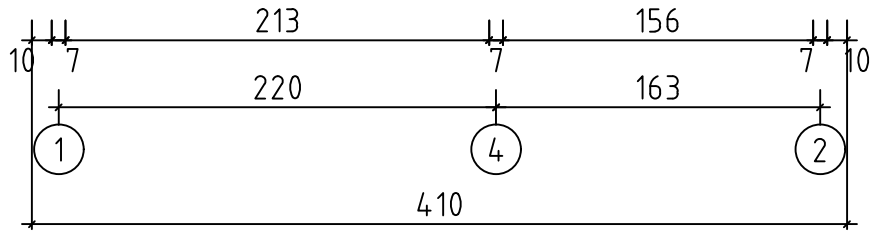
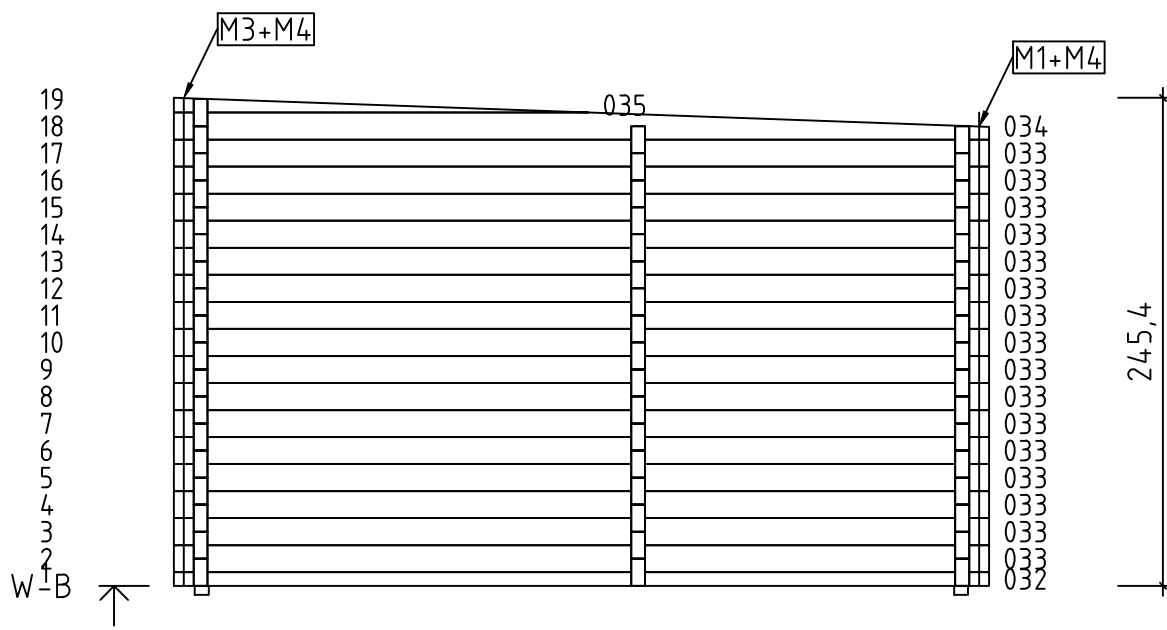
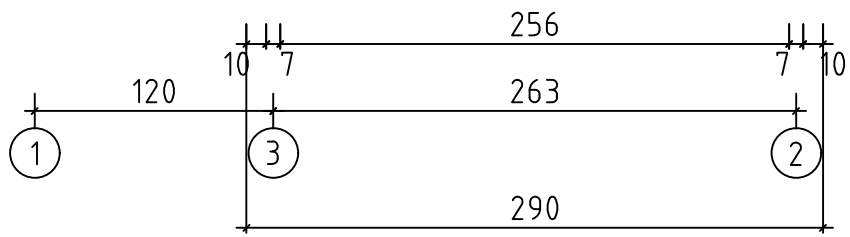
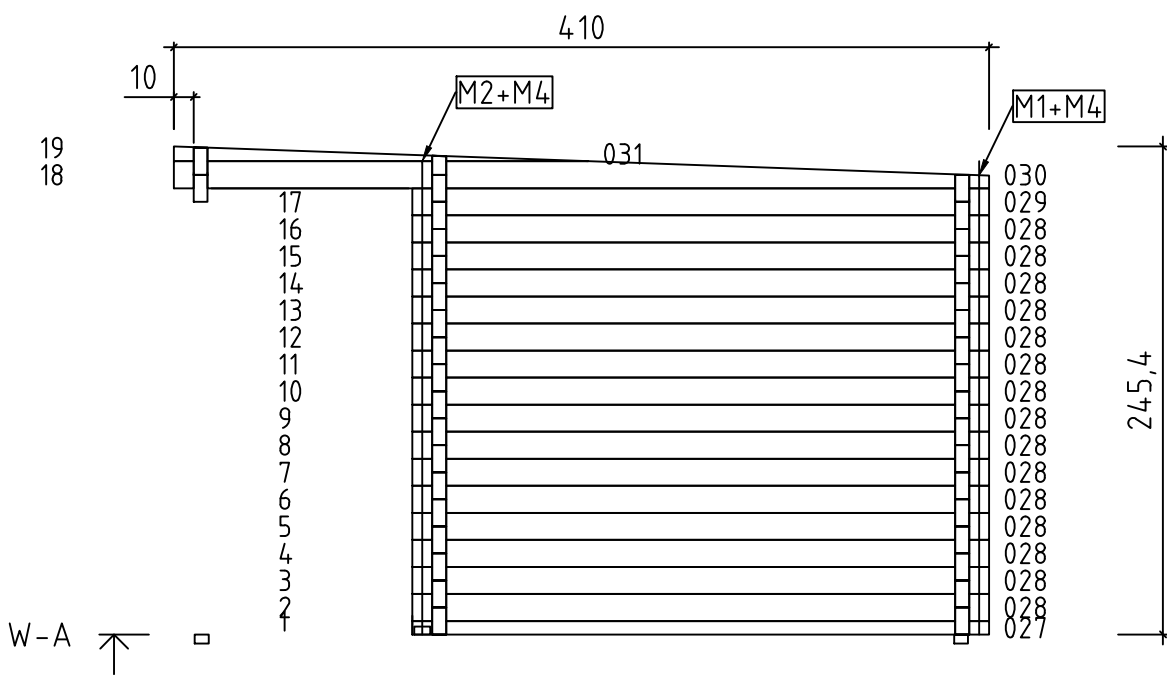

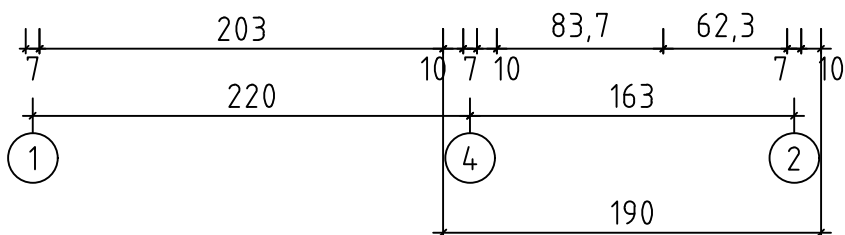
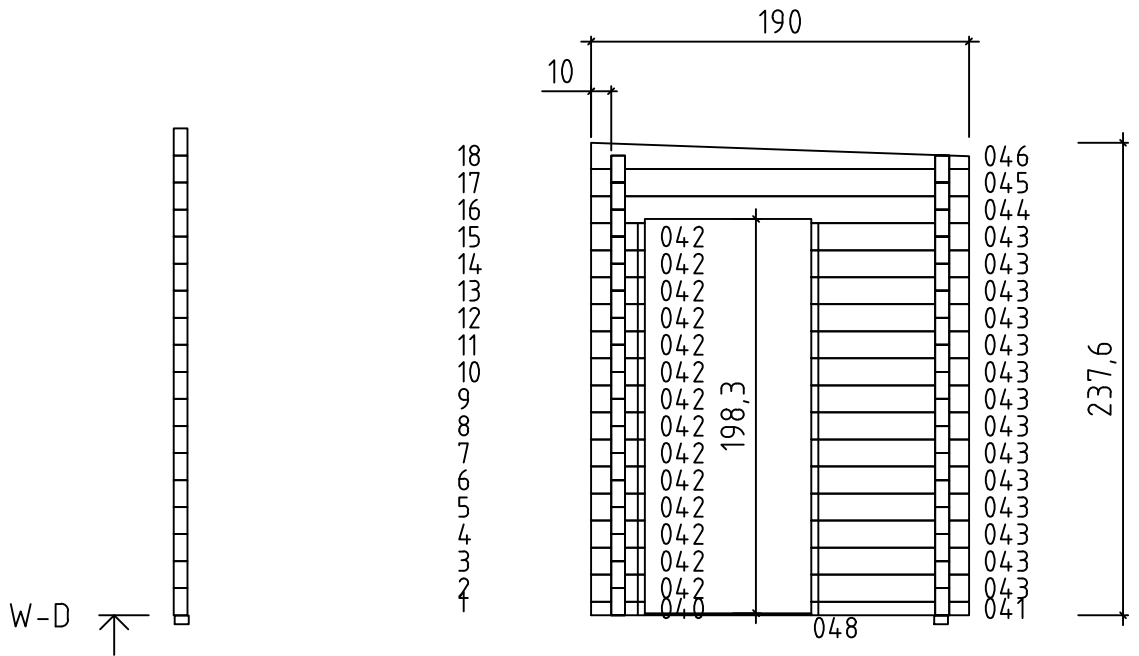
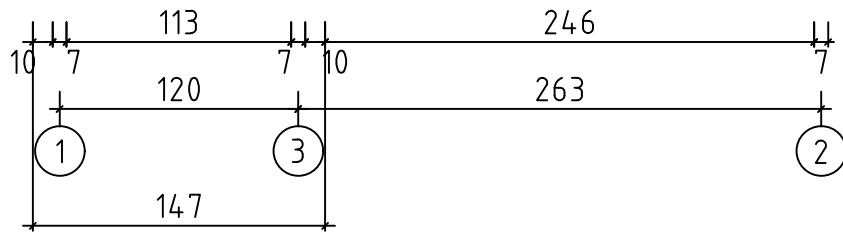
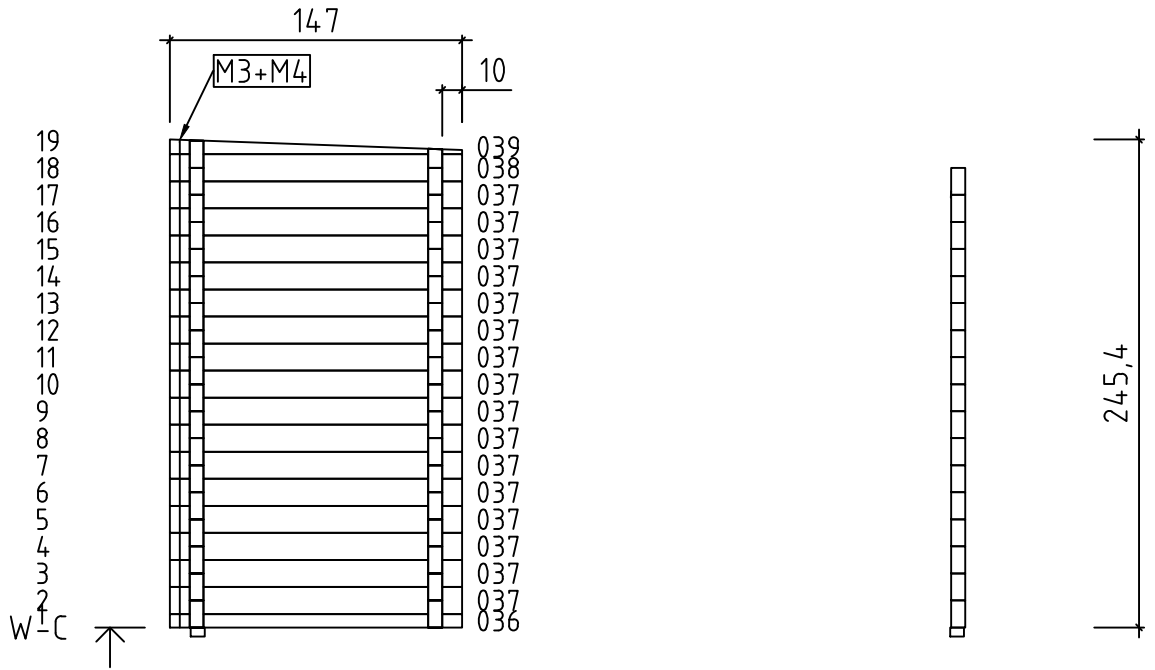

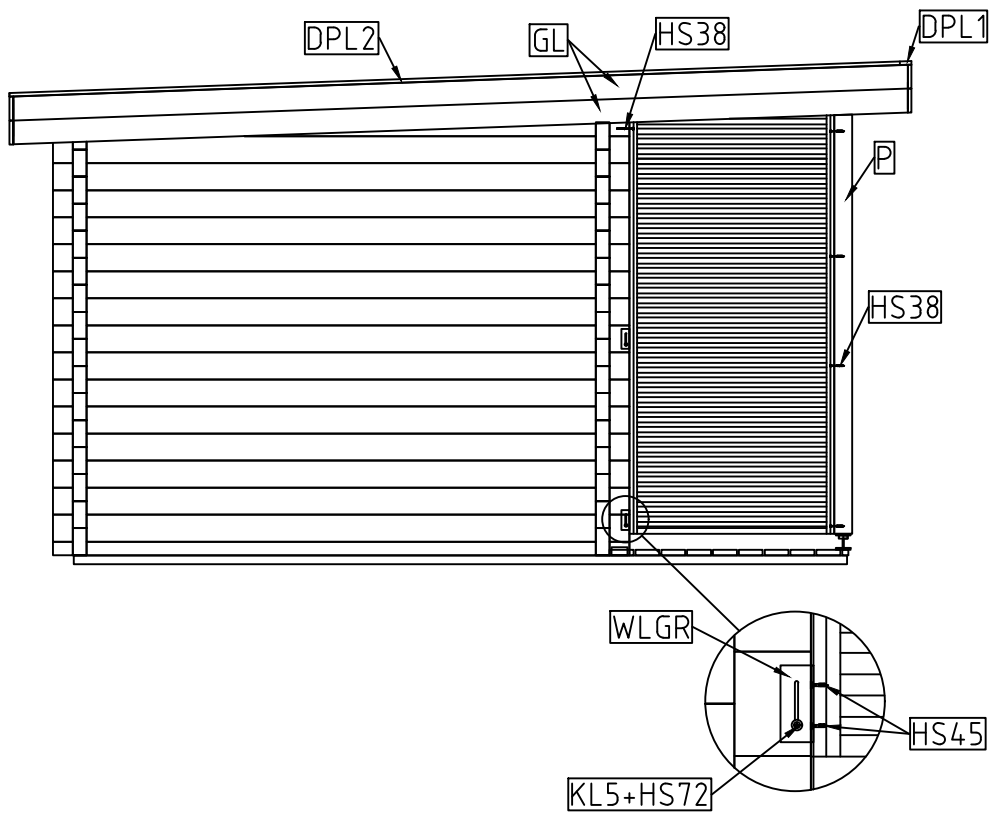
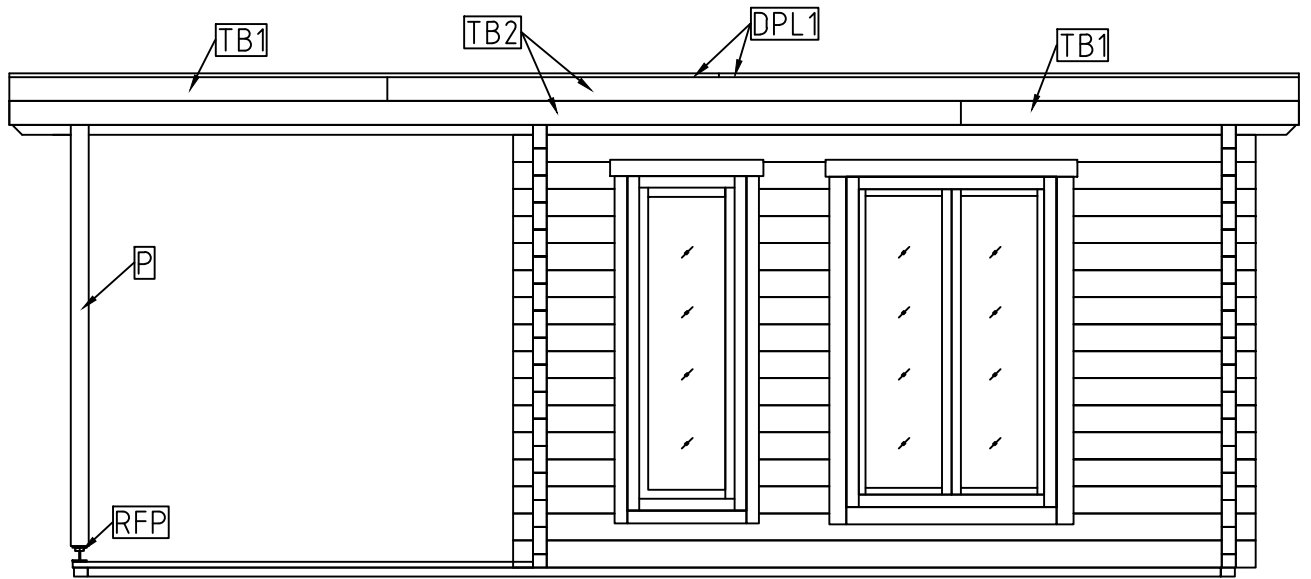

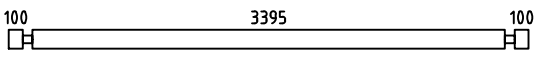

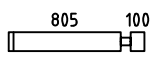
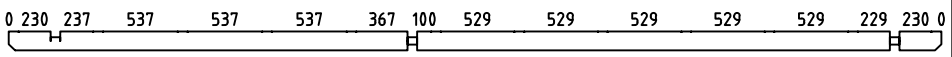
ORKNEY 5, Art.No.704641





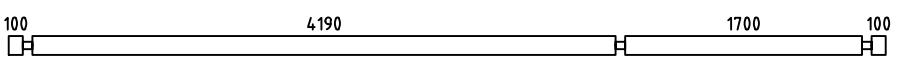
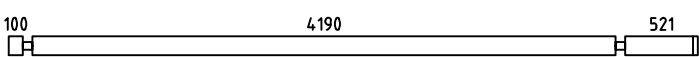
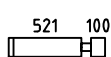
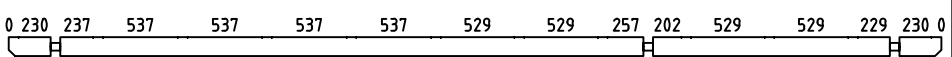

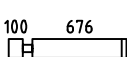

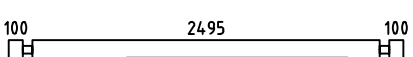
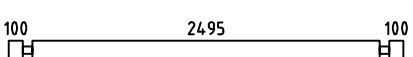
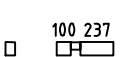
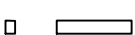
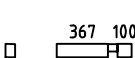

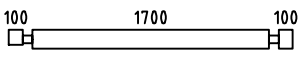
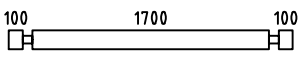
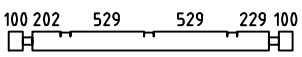
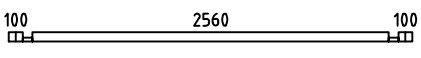
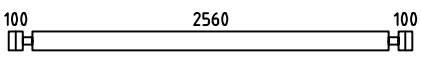
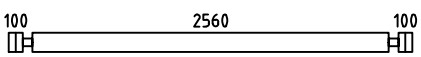
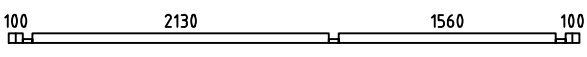
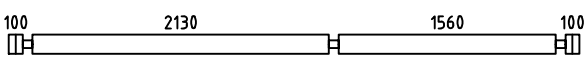
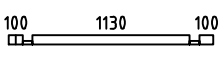
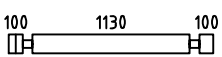

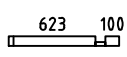

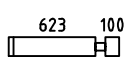
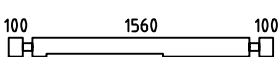
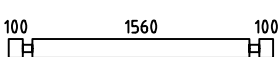
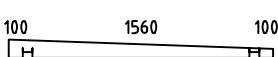

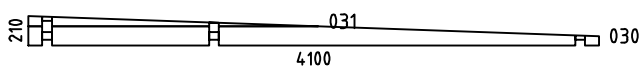
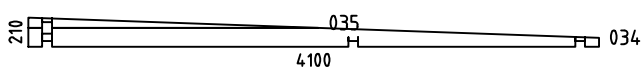
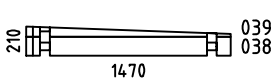





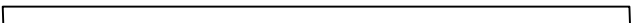
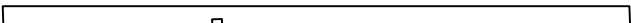





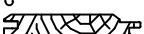
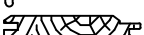
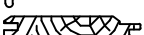
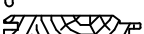
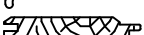
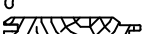
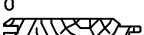













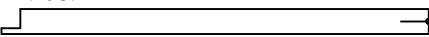
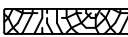
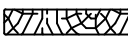



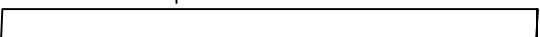





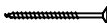
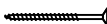













Pos	ORKNEY 5, Art.No.704641 Piece list - Stückliste - Liste des pièces - Elementi - Stuklijst - Tükítabel	Q	P (mm)	L (mm)
001		3	70x136	3735
002		13	70x136	593
003		13	70x136	495
004		13	70x136	975
005		1	70x136	6700
006		2	70x136	537
007		7	70x136	537
008		1	70x136	537
009		9	70x136	529
010		2	70x136	529
011		10	70x136	6300
012		5	70x136	4951
013		5	70x136	691
014		1	70x136	6700
015		1	70x136	529
016		15	70x136	846
017		1	70x136	399
018		14	70x136	399
019		1	70x136	2835
020		1	70x136	2835
021		1	70x96	407
022		3	70x96	537
023		1	70x96	537

Pos	ORKNEY 5, Art.No.704641 Piece list - Stückliste - Liste des pièces - Elementi - Stuklijst - Tükítabel	Q	P (mm)	L (mm)
024		1	70x136	2040
025		15	70x136	2040
026		1	70x136	2040
027		1	70x68	2900
028		15	70x136	2900
029		1	70x136	2900
032		1	70x68	4100
033		16	70x136	4100
036		1	70x68	1470
037		16	70x136	1470
040		1	70x68	270
041		1	70x68	793
042		14	70x136	270
043		14	70x136	793
044		1	70x136	1900
045		1	70x136	1900
046		1	70x132	1900
047		1	70x10	1590
048		1	70x10	837
WA-1		1		
WB-1		1		
WC-1		1		
IAR2	Foundation - Fundament - Fondation - Fondamenta - Fundering - Immutatud alusraam 	2	70x45	6090

Pos	ORKNEY 5, Art.No.704641 Piece list - Stückliste - Liste des pièces - Elementi - Stuklijst - Tükítabel	Q	P (mm)	L (mm)
IAR1	Foundation - Fundament - Fondation - Fondamenta - Fundering - Immutatud alusraam 	16	70x45	3750
IAR3	Foundation - Fundament - Fondation - Fondamenta - Fundering - Immutatud alusraam 	5	70x45	421
SR1	Rafter - Dachsparren - Chevron - Trave - Dak spar - Sarikas 	5	70x140	4508
SR7	Rafter - Dachsparren - Chevron - Trave - Dak spar - Sarikas 	4	70x140	4508
SR8	Rafter - Dachsparren - Chevron - Trave - Dak spar - Sarikas 	3	70x140	4508
SR2	Rafter - Dachsparren - Chevron - Trave - Dak spar - Sarikas 	1	45x45	2563
SR6	Rafter - Dachsparren - Chevron - Trave - Dak spar - Sarikas 	1	45x45	2133
SR5	Rafter - Dachsparren - Chevron - Trave - Dak spar - Sarikas 	3	45x45	1563
SR4	Rafter - Dachsparren - Chevron - Trave - Dak spar - Sarikas 	1	45x45	1132
SR3	Rafter - Dachsparren - Chevron - Trave - Dak spar - Sarikas 	4	45x45	202
STP	Ceiling boards - Deckenbrett - Voliges sous plafond - Tavole per piano soffitto - Dakhout - Laelaud 	14	111x15	4186
STP	Ceiling boards - Deckenbrett - Voliges sous plafond - Tavole per piano soffitto - Dakhout - Laelaud 	5	111x15	3896
STP	Ceiling boards - Deckenbrett - Voliges sous plafond - Tavole per piano soffitto - Dakhout - Laelaud 	5	111x15	3865
STP	Ceiling boards - Deckenbrett - Voliges sous plafond - Tavole per piano soffitto - Dakhout - Laelaud 	10	111x15	3391
STP	Ceiling boards - Deckenbrett - Voliges sous plafond - Tavole per piano soffitto - Dakhout - Laelaud 	5	111x15	2091
STP	Ceiling boards - Deckenbrett - Voliges sous plafond - Tavole per piano soffitto - Dakhout - Laelaud 	5	111x15	2060
STP	Ceiling boards - Deckenbrett - Voliges sous plafond - Tavole per piano soffitto - Dakhout - Laelaud 	14	111x15	1696
HLL	Floor boards - Fussbodenbretter - Lamé de plancher - Pavimento - Vloerhout - Põrandalaud 		137x28	159 m.
RB-1	Roof boards - Dachbretter - Voliges - Perlina per tetto - Dakhout - Katuselaud 	25	90x18	4268
RB-2	Roof boards - Dachbretter - Voliges - Perlina per tetto - Dakhout - Katuselaud 	25	90x18	4237
RB-3	Roof boards - Dachbretter - Voliges - Perlina per tetto - Dakhout - Katuselaud 	25	90x18	2463
RB-4	Roof boards - Dachbretter - Voliges - Perlina per tetto - Dakhout - Katuselaud 	25	90x18	2432
SV2	Terrace boards - Terrassenbretter - Plancher de terrasse - Piattaforme terrazzo - Terrasvloer - Terrassilaud 	10	120x28	2565



Pos	ORKNEY 5, Art.No.704641 Piece list - Stückliste - Liste des pièces - Elementi - Stuklijst - Tükítabel	Q	P (mm)	L (mm)
FL	Floor fillet - Fussbodenleiste - Corniere de finition du plancher - Finitura per pavimento (battisco pa) - Vloerafwerkljst - Pörandaliist 		15x40	26 m.
LL	Ceiling fillet - Deckeleiste - Profil de finition sous plafond - Massello per soffitto - Dak afdekljst - Laeliist 		15x40	26 m.
DPL1	Roofing felt fillet - Dachpappenleiste - Baguette de fixation du feutre bitumeux - Asse per fissaggio guaina bituminosa - Afdekljst asfaltpapier - Katusepapiilist 	2	18x58	3369
DPL2	Roofing felt fillet - Dachpappenleiste - Baguette de fixation du feutre bitumeux - Asse per fissaggio guaina bituminosa - Afdekljst asfaltpapier - Katusepapiilist 	2	18x58	4481
M1	Treaded rod m12 - Gewindestange m12 - Tige filetée m12 - Barra filettata passo m12 - Draadstang 12m - Keermelatt 	2		270
M2	Treaded rod m12 - Gewindestange m12 - Tige filetée m12 - Barra filettata passo m12 - Draadstang 12m - Keermelatt 	1		360
M3	Treaded rod m12 - Gewindestange m12 - Tige filetée m12 - Barra filettata passo m12 - Draadstang 12m - Keermelatt 	2		410
M4	Treaded rod m12 - Gewindestange m12 - Tige filetée m12 - Barra filettata passo m12 - Draadstang 12m - Keermelatt 	5		2000
p	Post - Pfosten - Poteau - Piede registrabile - Stijl - Post 	1	90x90	2136
TB1	Fascia board - Traufbrett - Bandeau de toit - Finitura lati tetto - Gevellijst - Räästalaud 	4	18x120	1862
TB2	Fascia board - Traufbrett - Bandeau de toit - Finitura lati tetto - Gevellijst - Räästalaud 	4	18x120	4876
TBE6	Fixing fillet - Fixierungsleiste - Profil de fixation - Massello di fissaggio - Bevestiging lijstwerk - Tenderliist 	2	28x34	650
TBE6	Fixing fillet - Fixierungsleiste - Profil de fixation - Massello di fissaggio - Bevestiging lijstwerk - Tenderliist 	4	28x34	1729
TBE6	Fixing fillet - Fixierungsleiste - Profil de fixation - Massello di fissaggio - Bevestiging lijstwerk - Tenderliist 	2	28x34	1890
TBE6	Fixing fillet - Fixierungsleiste - Profil de fixation - Massello di fissaggio - Bevestiging lijstwerk - Tenderliist 	2	28x34	1990
GL	Gable moulding - Giebelleiste - Planche de rive - Finitura per frontale e retro del tetto - Gevellijst - Viitulaud 	4	18x120	4504
KL4	Lengthening bolt for treaded rod - Verlängerungsmutter für gewindestange - Manchon de raccordement de tige filetée - Bullone per barra filettata passo - Extensie moer voor draadstang - Jätkumutter keermelatile 	5		
KL1	Drive nut treaded rod - Einschlagmutter für gewindestange - Écrou a frapper pour tige filitée - Dado guida per barra filettata - Aandrijfmoer / aanslagmoer voor draadstang - Löökmutter keermelatile 	5		
KL2	Nut for treaded rod - Mutter für gewindestange - Écrou pour tige filetée - Dado per barra filettata - Moer voor draadstang - Mutter keermelatile 	5		
KL3	Plain washer treaded rod - Unterlegscheibe für gewindestange - Rondelle plate pour tige filetée - Rondella per barra filettata - Sluiring voor draadeind - Seib keermelatile 	5		
HS25	Screw for floor - Schrauben für fussbodenbretter - Vis pour plancher - Viti per le perline del pavimento - Schroef voor vloerhout - Kruvi pörandale 	430	3.5x50	
HS32	Screw for fascia boards - Schrauben für traufbretter - Vis pour fixation bandeau de toit - Viti x striscia del tetto - Schroef voor gevellijst - Kruvi räästalaule 	104	3.5x50	
HS84	Screw for fixing fillet of door and window - Schrauben für fixierungsleiste - Vis pour profil vertical de fixation pour ouvertures des fenetres et portes - Viti per massello di fissaggio - Schroeven voor bevestiging van deur en raam lijsten - Kruvi tenderliistudele 	46	3.5x50	

Pos	ORKNEY 5, Art.No.704641 Piece list - Stückliste - Liste des pièces - Elementi - Stuklijst - Tükítabel	Q	P (mm)	L (mm)
HS16	Screw for gable moulding - Schrauben für giebelleiste - Vis pour fixation planche de rive - Vite per fissare finitura davanti e dietro del tetto - Schroef voor gevellijst - Kruvi viilulauale 	48	3.5x50	
HS38	Screw for fixing terrace railing - Schraube für terrasse - Vis de fixation de garde-corps de terrasse - Vite per fissaggio della ringhiera al terrazzo - Schroef voor terras - Kruvi piirdeaia kinnituseks 	5	4.5x80	
HS37	Screw for post - Schrauben für pfosten - Vis de fixation des poteaux - Viti per inviare - Schroef voor stijlen - Kruvi postile 	2	4.5x80	
HS45	Screw for sliding wall tie - Schieberegler für wand - Sabot métallique pour fixation mur - Vite per fissare scorrimento a c su slitta fissata alla parete - Schuifdeur instellingen wand - Kruvi seinaliugurile 	8	4x20	
NFD	Screw for roofing felt fillet - Schrauben für dachpappenteiste - Vis pour fixation baguette de fixation feutre bitumeux - Vite per massellino del feltro del tetto - Schroef voor asfaltpaier afdekljst - Kruvi katusepapiistule 	36	4x40	
HS39	Screw for foundation - Schrauben zur befestigung fundament - Vis de fixations des poutrelles de fondations - Viti x fondamenta - Schroef voor fundering - Kruvi alusraamile 	54	5x120	
	Screw for gable - Schrauben für giebel - Vis pour fixation des pignons - Viti per timpano - Schroef voor gevelpunt - Kruvi viilude kinnitamiseks 	7	5x120	
HS78	Screw for pos. 021-023 - Schrauben für pos. 021-023 - Vis pour pos 021-023 - Viti per fissare elemento vedi figura in pos. n. 021-023 - Schroef voor pos. 021-023 - Kruvi pos. 021-023 	10	5x120	
HS81	Screw for ceiling board holder - Schraube für halter für deckengbretter halter - Vis de fixation support pour panneaux de plafond - La vite per il listello di fissare il tavolo del soffitto - Schroef voor bevestiging aan de plafondplaat - Kruvi laelaua kinnitusliistule 	30	5x90	
HS48	Screw for pos. 006-010; 015 - Schrauben für pos. 006-010; 015 - Vis pour pos. 006-010; 015 - Viti per fissare elemento vedi figura in pos. n. 006-010; 015 - Schroef voor pos. 006-010; 015 - Kruvi pos. 006-010; 015 	44	6x180	
HS44	Screw for rafter - Schrauben für dachsparren - Vis pour chevron - Vite per trave - Schroef voor dakspar - Kruvi sarikatele 	31	6x180	
HS49	Screw for post height adjustment - Schrauben für regulierungsschraube für pfosten - Vis de fixation de support réglable de poteau - Viti per fissare ed aggiustare l'altezza del palo verticale - Schroef voor hoogte instelling stijlen - Kruvi vajumisplidile 	8	6x50	
NF3	Screw for terrace - Schrauben für terrassenbretter - Vis pour fixation de terrasse - Viti per terrazza - Schroef voor terrasvloer - Kruvi terrasilauale 	120	4.2x55	
HS72	Screw for sliding wall tie - Schieberegler für wand - Sabot métallique pour fixation mur - Vite per fissare scorrimento a c su slitta fissata alla parete - Schuifdeur instellingen wand - Kruvi seinaliugurile 	2	5x60	
SH70	Hammer block - Schlagholz - Calle de frappe - Blocco di legno da usare come cuscinetto quando si usa il martello - Slagklos - Löögiklots 	2		
	Screw for doorstep - Schrauben für swelle - Vis pour fixation barre de seuil - Vite per soglia della porta - Schroef voor deurdorpel - Kruvi lävepakule 	5	4.5x65	
NFC	Zn nail for ceiling fillet - Zn nagel deckeiste - Pointe pour profil de finition sous plafond - Chiodi zincati per massellini del soffitto - Spijker(nagel) voor plafond afdekljst - Nael laeliistule 	52	1.4x40	
NFF	Zn nail for floor fillet - Zn nagel für fussbodenleiste - Pointe pour corniere de finition du plancher - Chiodi x fissaggio pavimento - Spijker(nagel) voor vloer afdekljst - Nael põrandaliistule 	52	1.4x40	
NF2	Zn nail for roof - Zn nagel für dachbretter - Pointe pour fixation voliges de toit - Chiodi x perline tetto - Spijker(nagel) voor dakhout - Nael katuselauale 	800	2.1x50	
NF2	Zn nail for ceiling boards - Zn nagel für deckenbretter - Clous pour voliges sous plafonds - Chiodo per il tavolo del soffitto - Spijkers voor plafondplaat - Nael laelauale 	450	2.1x50	
ORZ	Montage set for doors and windows - Montage set für türen und fenster - Jeu de montage portes et fenetres - Set di assemblaggio per porte e finestre - Montage set voor deur en raam - Orthez akna ja ukse montaaživahendid	1		
KL5	Plain washer - Unterlegscheibe - Rondelle plate - Rondella piana - Sluiring - Seib seina ja sarikaliugurile 6 mm 	2		
WLGR	Sliding wall tie - Schieberegler für wand - Sabot métallique pour fixation mur - Cravatta parete scorrevole - Schuifregelaar voor wand - Seinaliugur 	2		

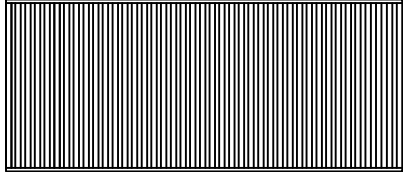
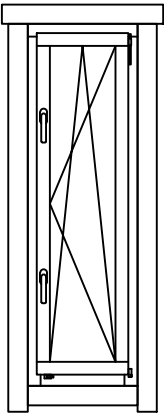
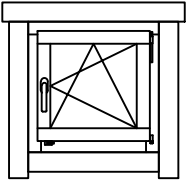
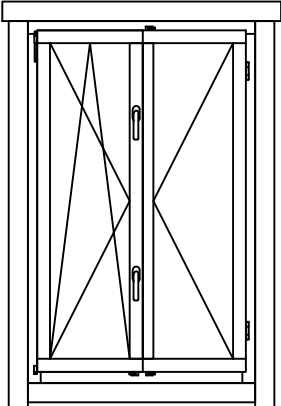
Pos	ORKNEY 5, Art.No.704641 Piece list - Stückliste - Liste des pièces - Elementi - Stuklijst - Tükítabel	Q	P (mm)	L (mm)
RFP	Post height adjustment - Pfostenträger verstellbar - Support réglable de poteau - Piede registrabile in altezza - Stelschroef voor stijlpost - Vajumispolt 	1		
	Terrace railing - Terrassenzaun - Garde-corps de terrasse - Ringhiera per terrazza - Terras rails (leuning) - Piiirdeaed  	1		1028
	Window - Fenster - Fenetre - Finestra - Raam - Aken <span style="float: right;">552x1729 2+ A.0P.b</span>  	1		
	Window - Fenster - Fenetre - Finestra - Raam - Aken <span style="float: right;">650x650 2+ A.0P.c</span>  	1		
	Window - Fenster - Fenetre - Finestra - Raam - Aken <span style="float: right;">1100x1729 2+ TA.0V.b</span>  	1		

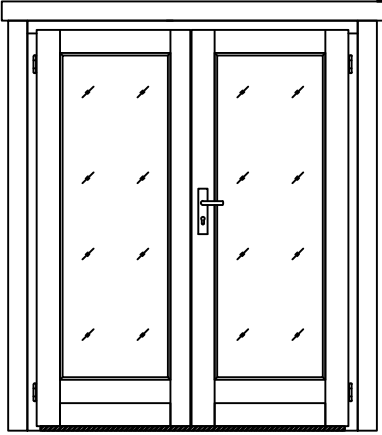
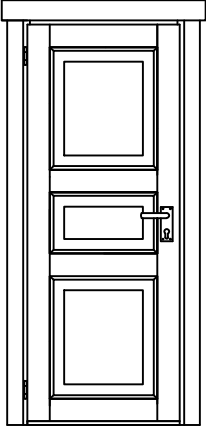
Pos	<p style="text-align: center;">ORKNEY 5, Art.No.704641            Piece list - Stückliste - Liste des pièces - Elementi - Stuklijst - Tükitabel</p>	Q	P (mm)	L (mm)
	<p>Door - Tür - Porte - Porte - Deur - Uks <span style="float: right;">1580x2000 2+ TU.10P.b</span></p> 	1		
	<p>Door - Tür - Porte - Porte - Deur - Uks <span style="float: right;">827x1933 U.3TV</span></p> 	1		

Pos	ORKNEY 5, Art.No.704641 Piece list - Stückliste - Liste des pièces - Elementi - Stuklijst - Tükítabel	Q	P (mm)	L (mm)
021a	□ <span style="display: inline-block; border: 1px solid black; padding: 2px;">100 237</span>	1	70x96	407
023a	□ <span style="display: inline-block; border: 1px solid black; padding: 2px;">367 100</span>	1	70x96	537

