

Technische Daten Saunahaus Sanna 70

Wandaußenmaß: 396 x 210 + 80 cm

Bohlenstärke: 70 mm



Kontrolliert durch:

Achtung: Alle angegebenen Maße sind ca.-Maße!

3D-Darstellung und Grundriss Saunahaus Sanna 70

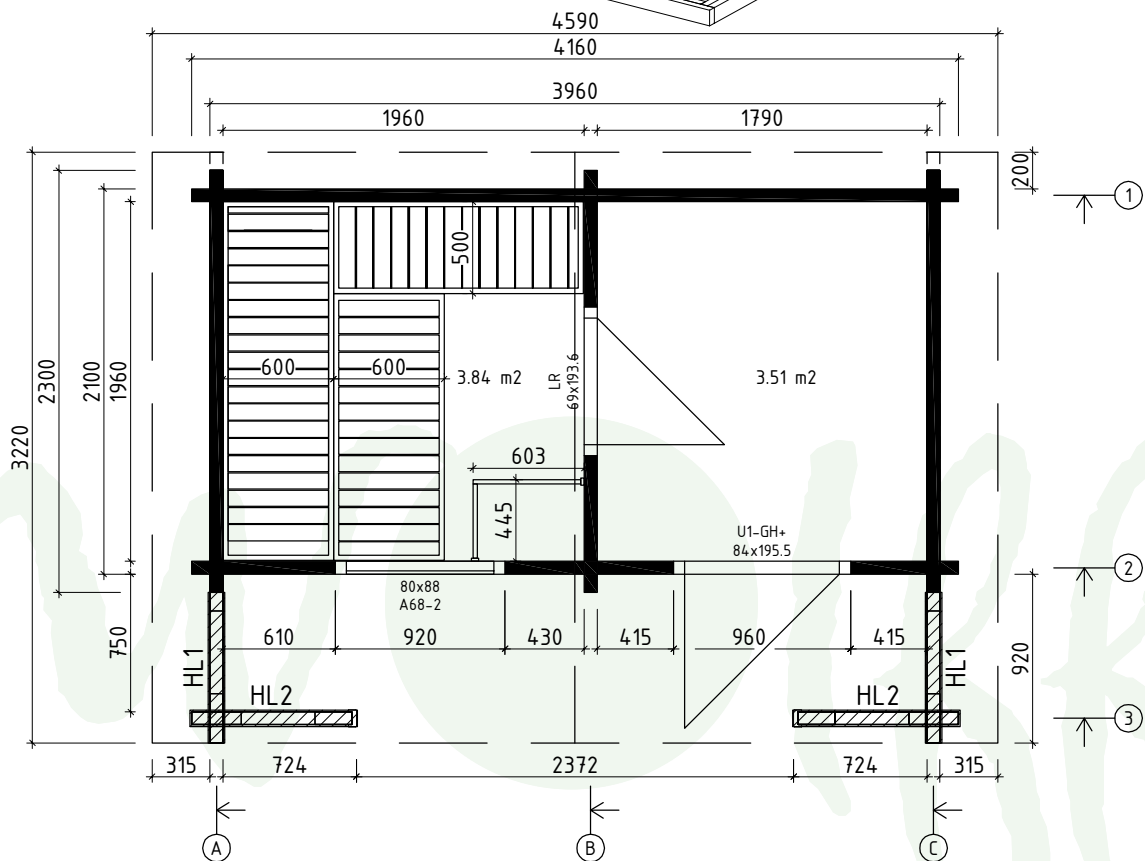
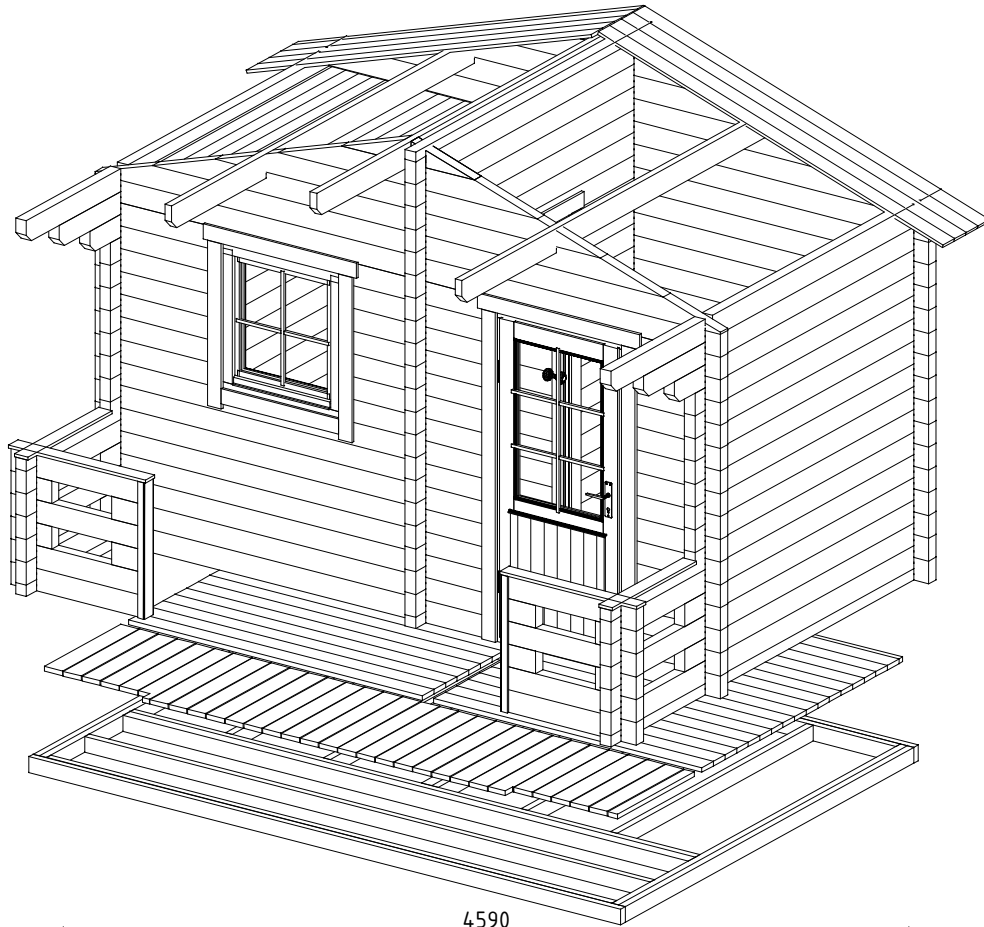

* Fenster und Türen sind mit Sprossen

Lagerholzplan und Fundamentplan Saunahaus Sanna 70

Wir empfehlen als Fundament für Ihr Gartenhaus eine vollflächig festgegründete, gepflasterte oder betonierte Fläche.
Wahlweise ist auch ein Punkt- oder Streifenfundament möglich.

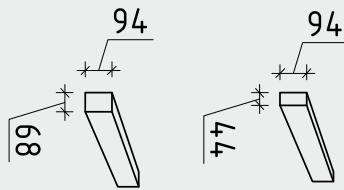
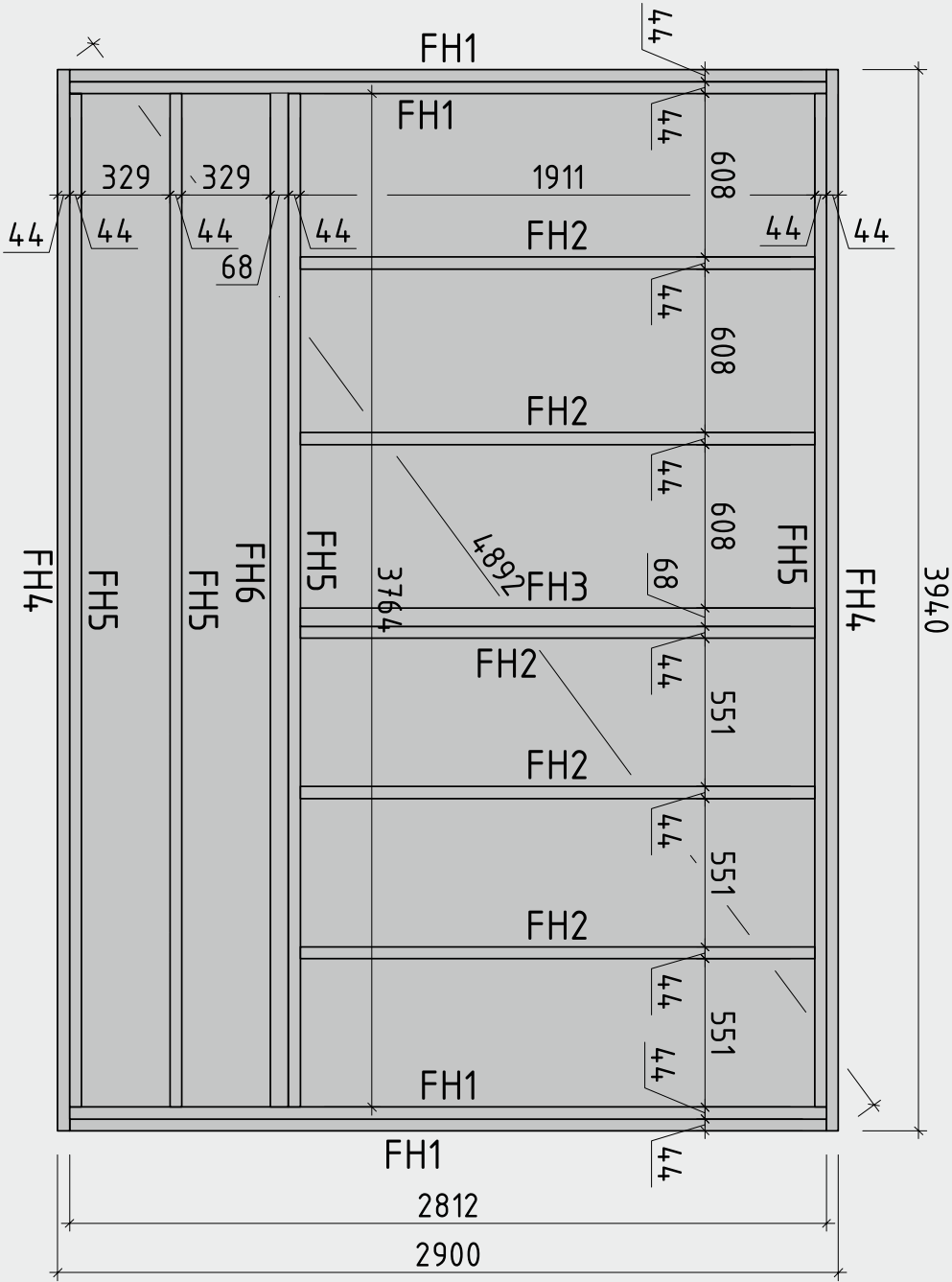











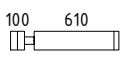
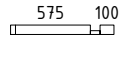
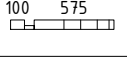
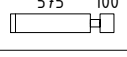
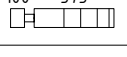
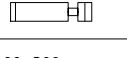
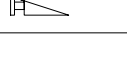
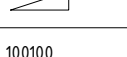
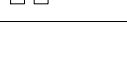
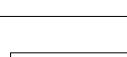
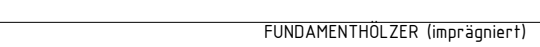

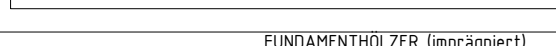
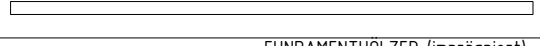
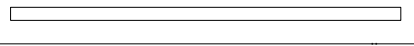
Teileliste 1

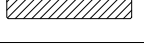
Saunahaus Sanna 70

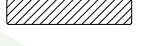
Pos		Stck	Profil (mm)	Länge (mm)
001		2	70x135	4160
002		15	70x135	4160
003		2	70x135	4160
004		2	70x135	3400
005		1	70x135	3220
006		1	70x135	3220
007		2	70x68	3120
008		4	70x135	3120
009		2	70x135	3120
010		2	70x135	3120
011		2	70x135	2800
012		6	70x135	2615
013		1	70x135	2615
014		1	70x135	2615
015		2	70x135	2561
016		2	70x135	2500
017		4	70x135	2400
018		19	70x135	2300
019		1	70x58	2300
020		1	70x135	2300
021		2	70x135	1722
022		7	70x135	915
023		4	70x135	870
024		2	70x135	870
025		2	70x135	870





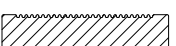
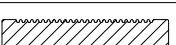











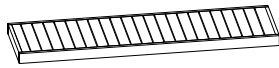
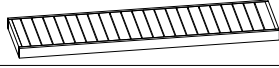

Teileliste 2

Saunahaus Sanna 70

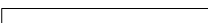
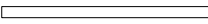
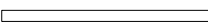
Pos		Stck	Profil (mm)	Länge (mm)
026		7	70x135	780
027		1	70x68	745
028		1	70x68	745
029		15	70x135	745
030		13	70x135	745
031		15	70x135	585
032		2	70x135	420
033		2	70x135	420
034		8	70x135	270
035		4	70x135	200
FH6	FUNDAMENTHÖLZER (imprägniert) 	1	68x94	3764
FH3	FUNDAMENTHÖLZER (imprägniert) 	1	68x94	1911
FH4	FUNDAMENTHÖLZER (imprägniert) 	2	44x94	3940
FH5	FUNDAMENTHÖLZER (imprägniert) 	4	44x94	3764
FH1	FUNDAMENTHÖLZER (imprägniert) 	4	44x94	2812
FH2	FUNDAMENTHÖLZER (imprägniert) 	5	44x94	1911
HL2	HANDLAUF  	✓ 2	90x18	910
HL1	HANDLAUF  	✓ 2	90x18	820
HS1	HÖLZSCHWELLE  (unter der Saunatur) 	✓ 1	75x28	750
PF1	PFETTEN 	3	44x145	3220
	DACHBRETTER 	58+1	113x18	2410
	FUSSBODENBRETTER 	18+1	113x28	1955
	FUSSBODENBRETTER 	18	113x28	1785
	TERRASSENBRETTER 	20+1	120x28	815
	TERRASSENBRETTER 	11	120x28	745

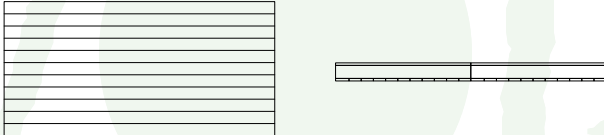

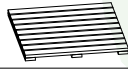







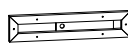
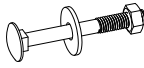

Teileliste 3

Saunahaus Sanna 70

Pos			Stck	Profil (mm)	Länge (mm)	
	ABDECKLEISTEN		✓	15x28	23,0 lfm	
	FUSSBODENLEISTE		✓	14x55	16,0 lfm	
G1-1	GIEBELBRETTER 120X18	 17,8°	✓	4	120x18	2490
G5-1	GIEBELDECKLEISTE 58X18	 17,8°	✓	4	58x18	2490
T2-1	TRAUFENBRETTER 90X18			2	90x18	3220
T4-1	TRAUFENLEISTE 40x18		✓		40x18	7,0 lfm
GS	Giebelsegment			2		
TL70-1	T-LEISTE 70			2	45x70	895
TL70-2	T-LEISTE 70			2	45x70	1908
TL70-3	T-LEISTE 70			2	45x70	1975
UP6-1	U-PROFIL 70		✓	2	44x94	810
SA02-1	SAUNA - Saunabank 50cm			1	500x90	1355
SA01-1	SAUNA - Saunabank 60cm			2	600x90	1955
SA11-1	SAUNA - Stützpfeiler für Saunabänke		✓	1	44x65	500
SA11-2	SAUNA - Stützpfeiler für Saunabänke		✓	2	44x65	1000
SA10-1	SAUNA - Trägleiste für Saunabänke		✓	3	30x40	600
SA10-2	SAUNA - Trägleiste für Saunabänke		✓	2	30x40	1200
SA16-1	SAUNA - Bänke Zwischenstück			1	40x300	1955
SA15-1	SAUNA - Rücklehne			2	40x250	1860
	DECKENISOLATION			2 Elemente	ca 1950x975	
SA20-1	SAUNA - Trägleiste für Deckenisolation		✓	4	35x35	2000
SA37	SAUNA - Bodenrost			1		
SA30	SAUNA - Heizung Umbau (set 1)			1		

Teileliste 4

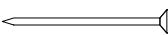
Saunahaus Sanna 70

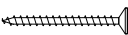
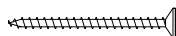
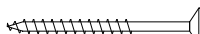
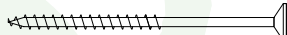
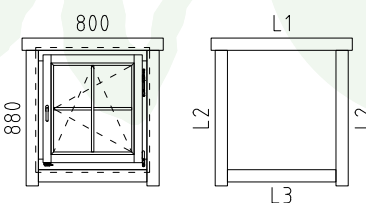
Pos			Stck	Profil (mm)	Länge (mm)
SA35	SAUNA - Kopfstütze		2		
SA36	SAUNA - Luftschieber		3		
SS14	Schloßschrauben M8x70 Mutter M8 U-Scheibe Ø25 - Befestigung für Saunabänke		2	M8	
SA2 5-1	SAUNA - Dichtungsband für Deckenisolationselemente				8,0 lfm
SH	Schlaghölzer		3		
KL1	Gewindestange M8		4	M8	2000
KL2	Gewindestange M8		2	M8	810
KL3	Gewindestange M8		4	M8	295
	Mutter M8 U-Scheibe Ø25		12	M8	
	Befestigungsmutter M8		4	M8	
	Schlagmutter M8		2	M8	
NG1	NÄGEL 2.5x50 Dachbretter		348		
NG2	NÄGEL 2.5x60 Fussbodenbretter		474		
SR01	SCHRAUBEN 3.0x30 Abdeckleiste, Fussbodenleiste Traufenleiste 40x18, Bänke Zwischenstück, Luftschieber		110		
SR03	SCHRAUBEN 3.5x45 Giebelbretter, Traufenbretter Giebelsegment, Handlauf, Heizung Umbau U-Profil, Fenster- und Türleisten		152		
SR05	SCHRAUBEN 4.0x60 Trägleiste für Saunabänke, Rücklehne Trägleiste für Deckenisolation		62		
SR55	SCHRAUBEN 5.0x70 Stützpfeiler für Saunabänke		10		
SR11	SCHRAUBEN 5.0x100 Fundamenthölzer		68		
	FENSTER 800x880		1		
	 <p style="text-align: center;">A68-2</p> <p>L1 18x90 L=1040mm 2x L2 18x90 L=1000mm 4x L3 18x90 L=800mm 2x ✓</p> <p style="text-align: center;">Gehärtete Glas</p>				

Wandplan 1 Saunahaush Sanna 70

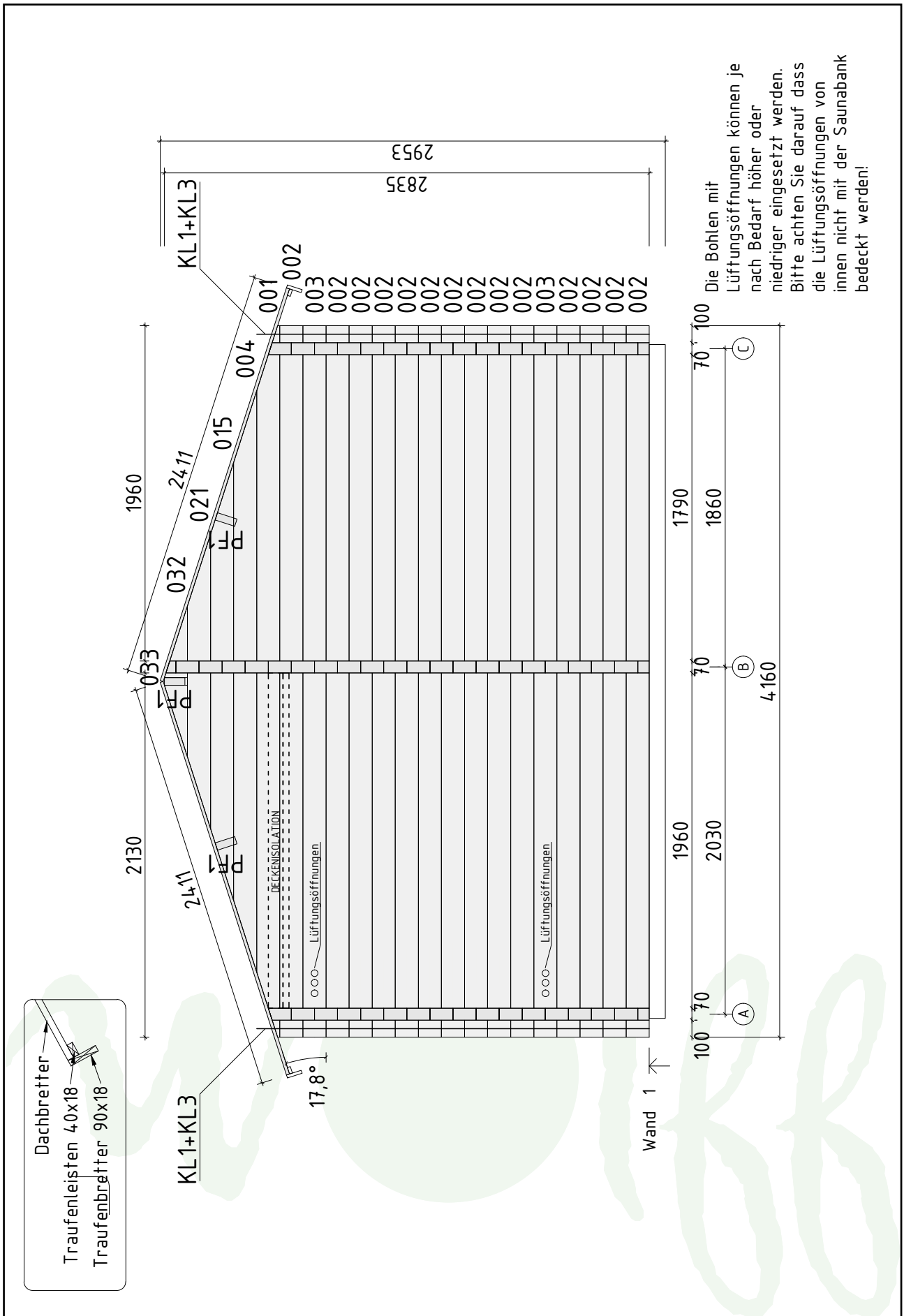

Die Bohlen mit Lüftungsöffnungen können je nach Bedarf höher oder niedriger eingesetzt werden. Bitte achten Sie darauf dass die Lüftungsöffnungen von innen nicht mit der Saunabank bedeckt werden!

Wandplan 2 Saunahaus Sanna 70

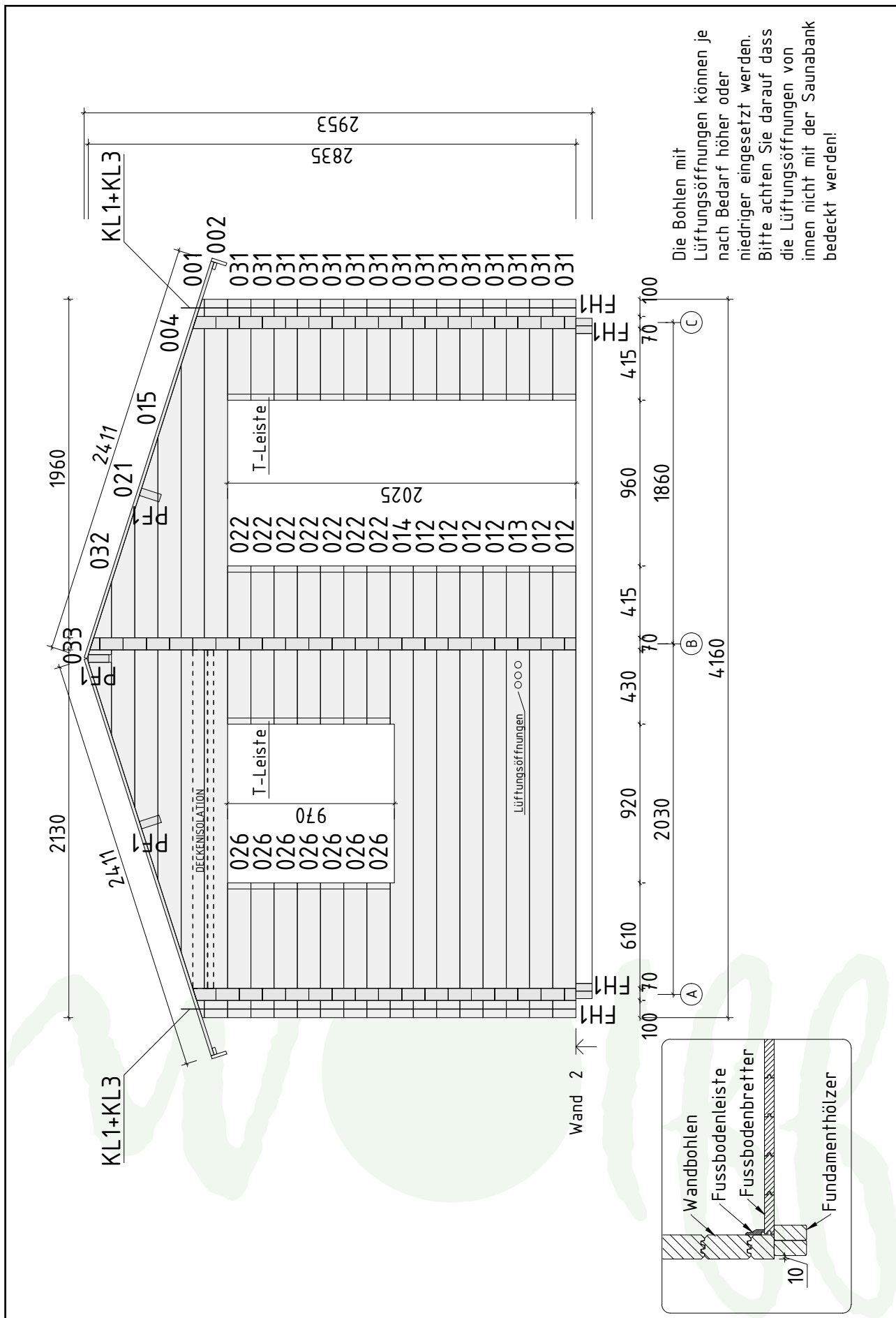

Wandplan 3 Saunahaus Sanna 70

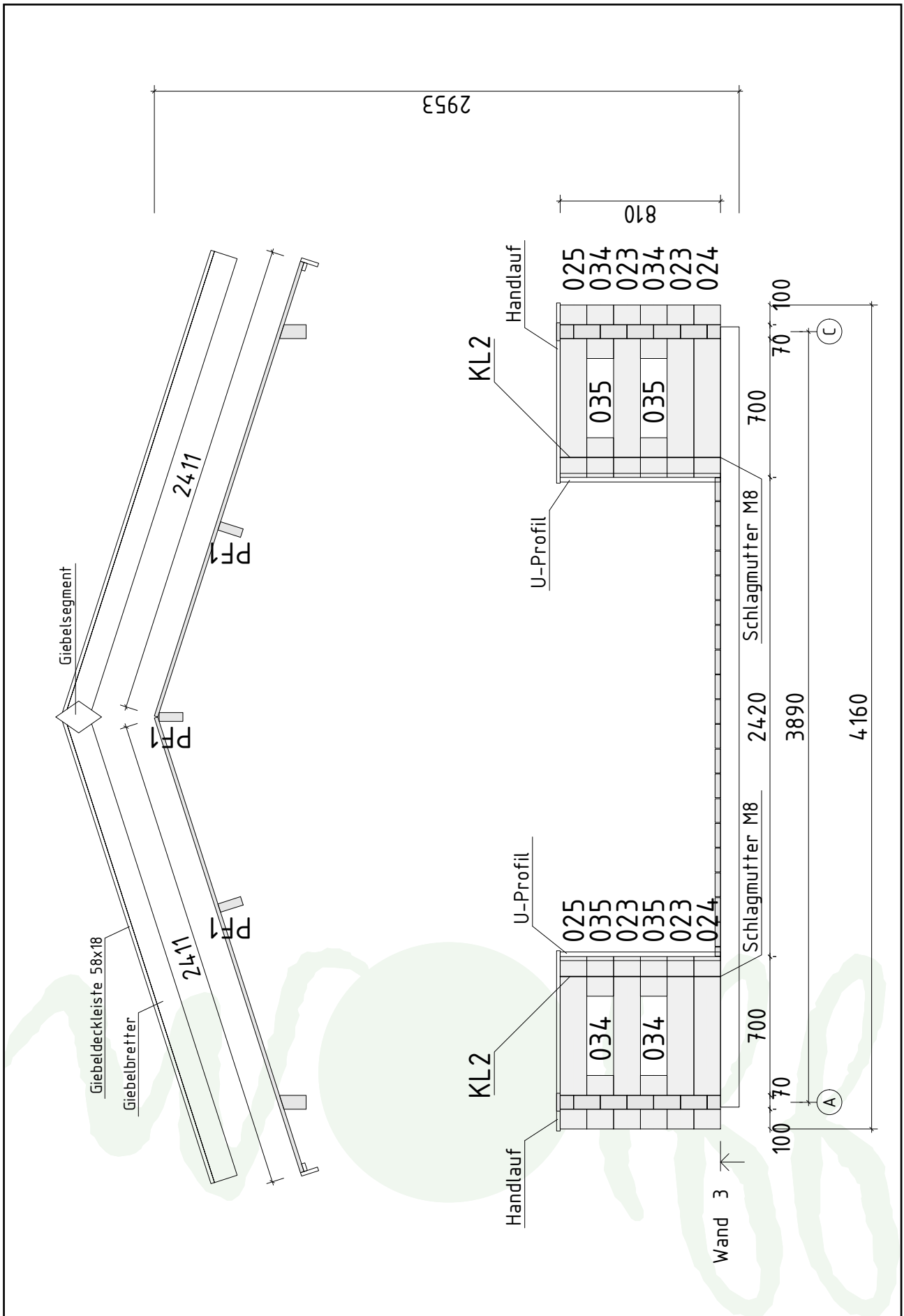

Wandplan A und B Saunahaus Sanna 70

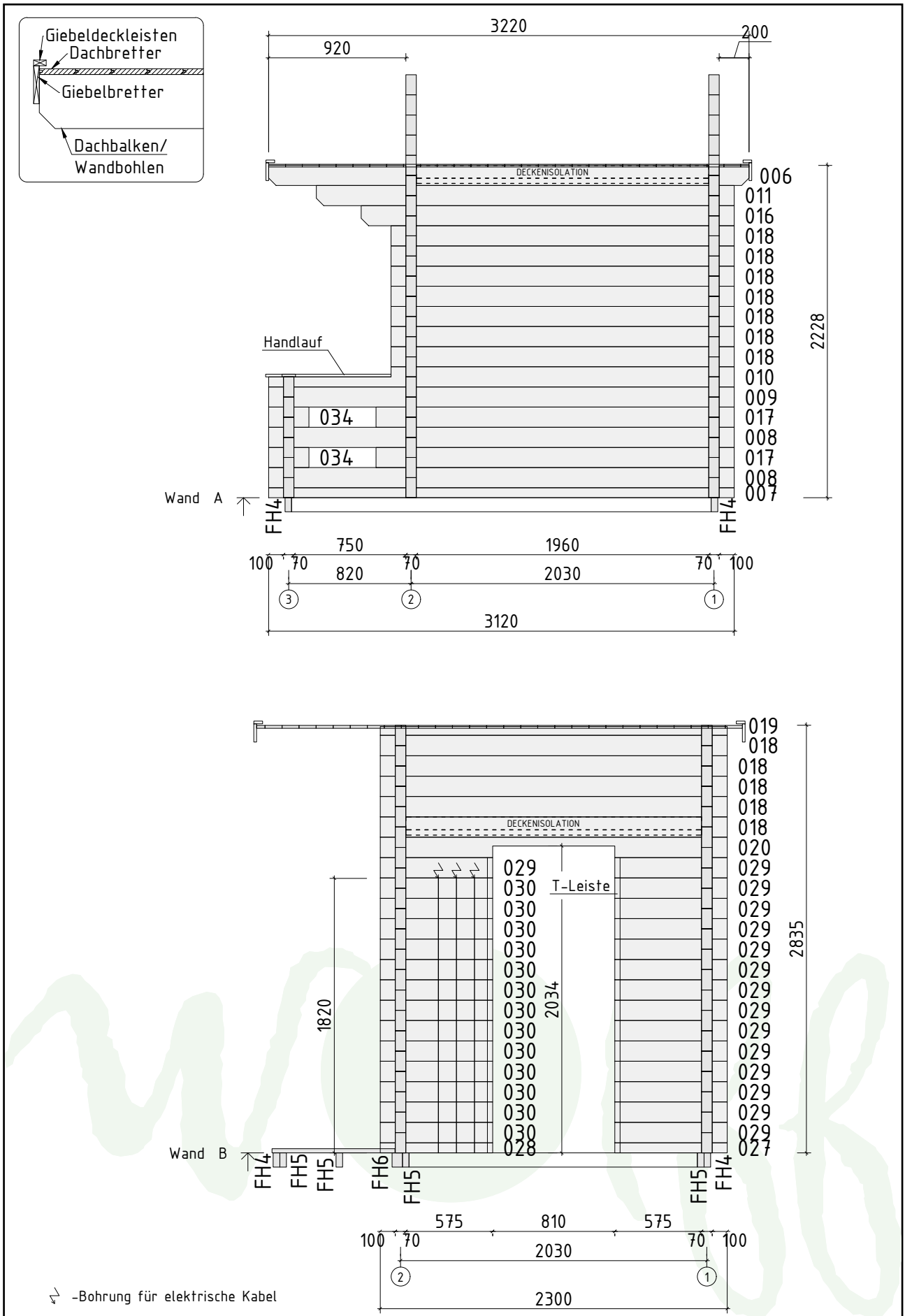

Wandplan C

Saunahaus Sanna 70

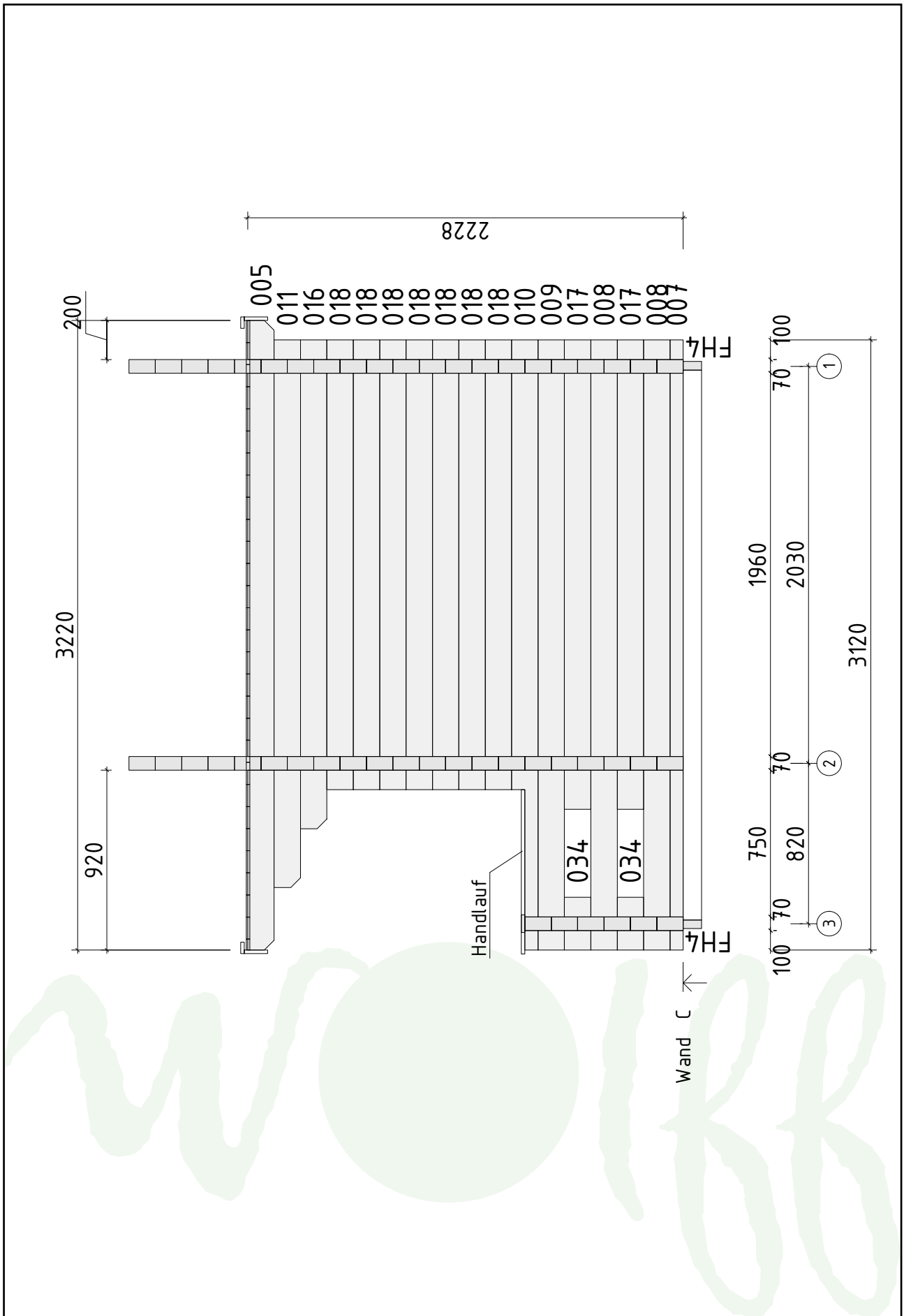

Detail

Saunahaus Sanna 70

Montageanleitung für T-Leisten / Installing the door and window supports / Tenderliistu paigaldusjuhend.

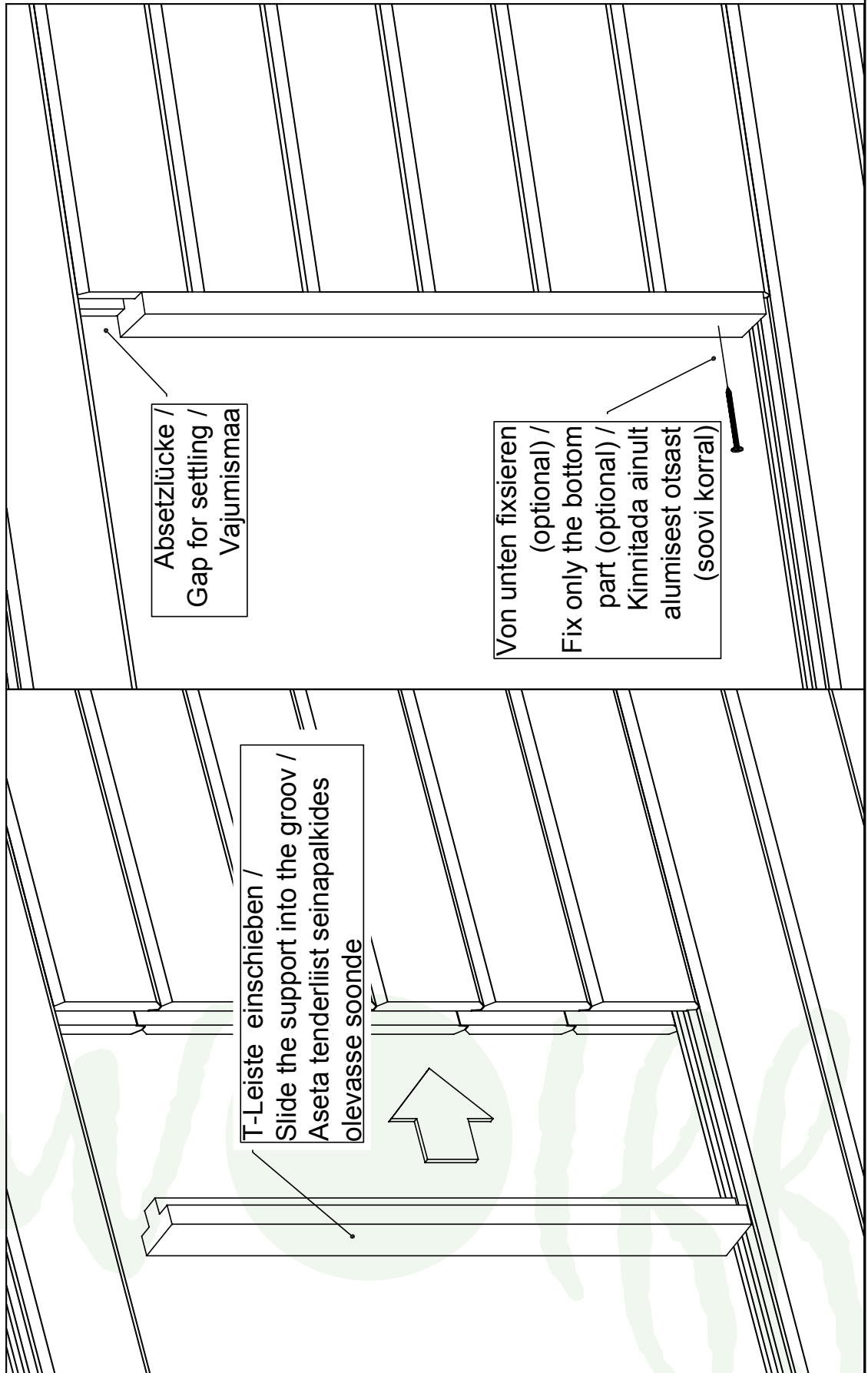

Detail

Saunahaus Sanna 70

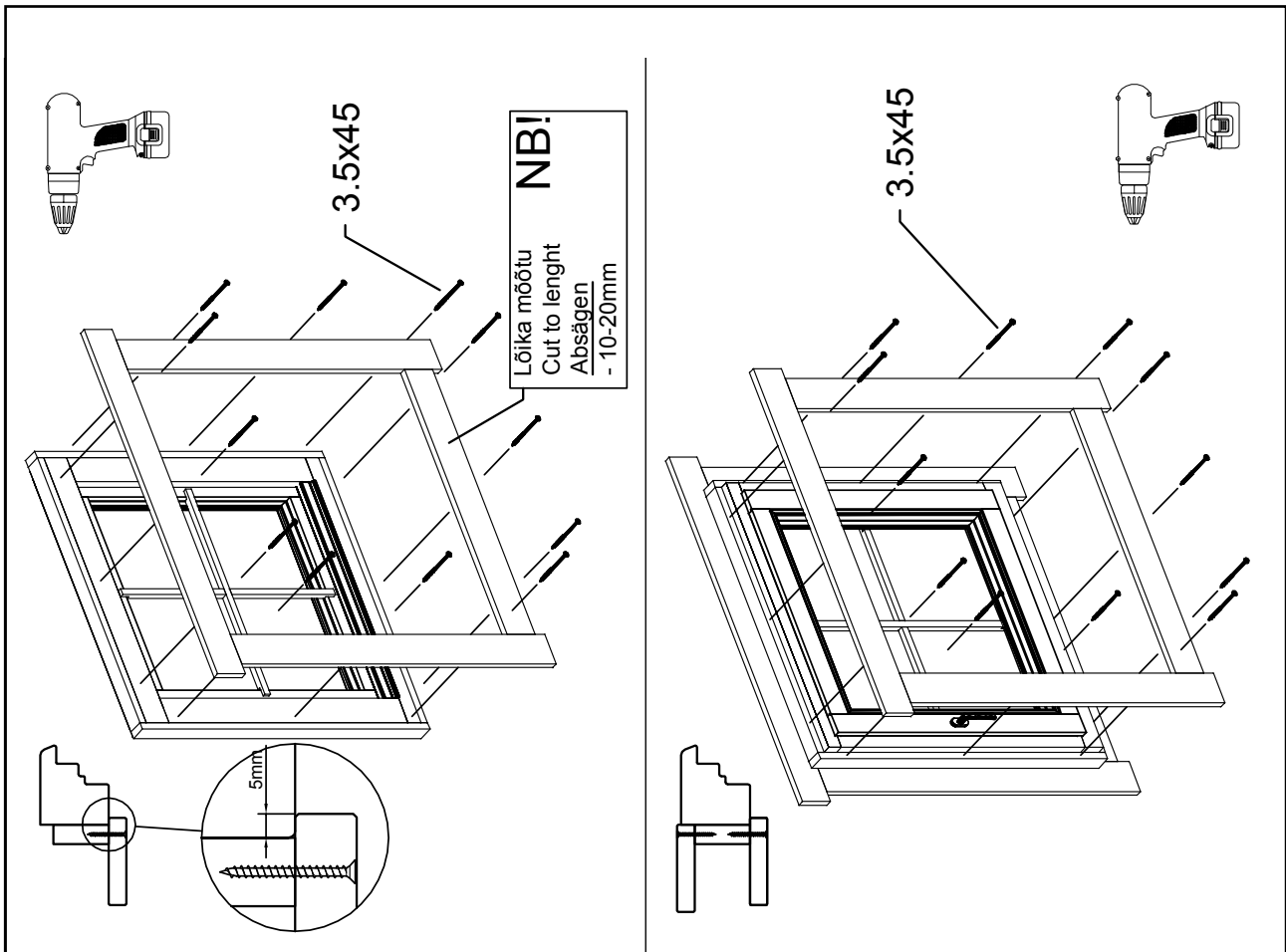

Akna tüüp / Fenster typ / Window type - A68
(GH+ / SH)

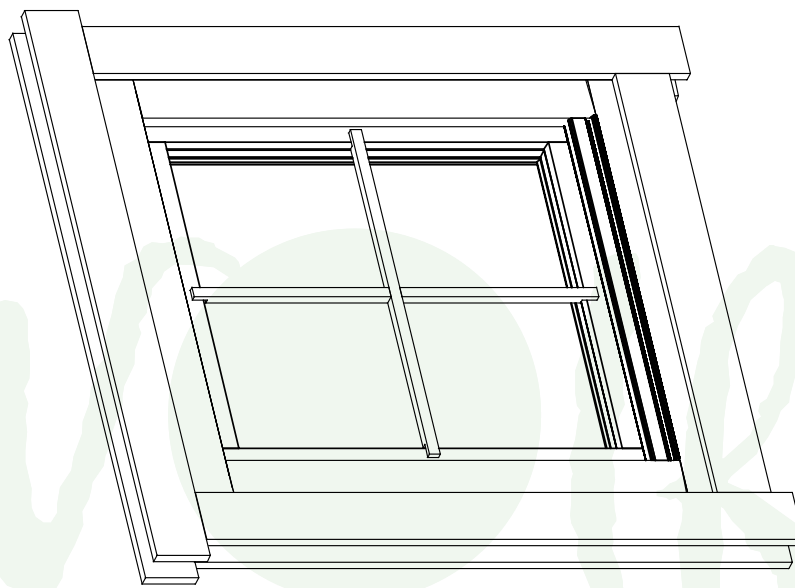

Detail Saunahaus Sanna 70

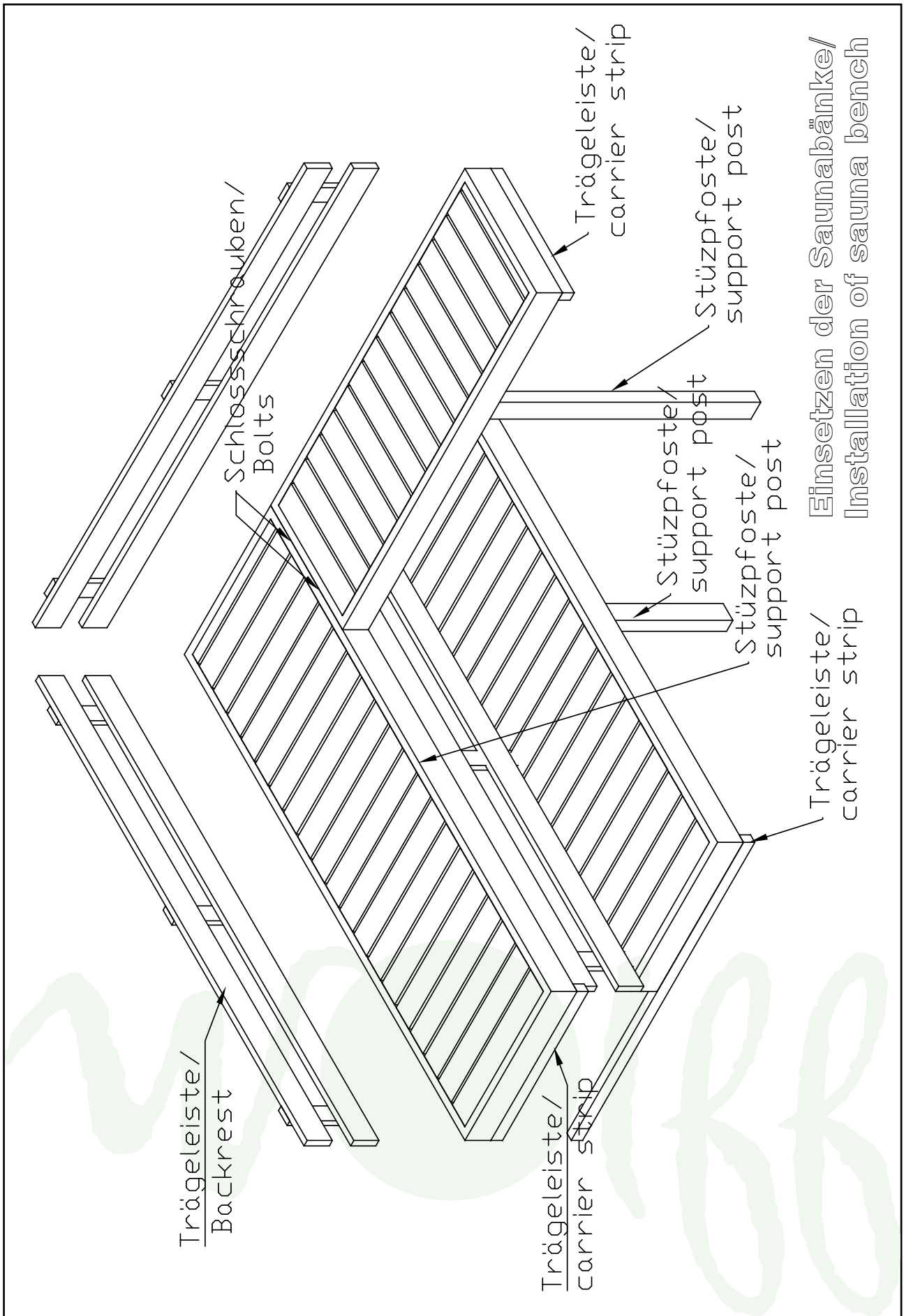

Detail

Saunahaus Sanna 70

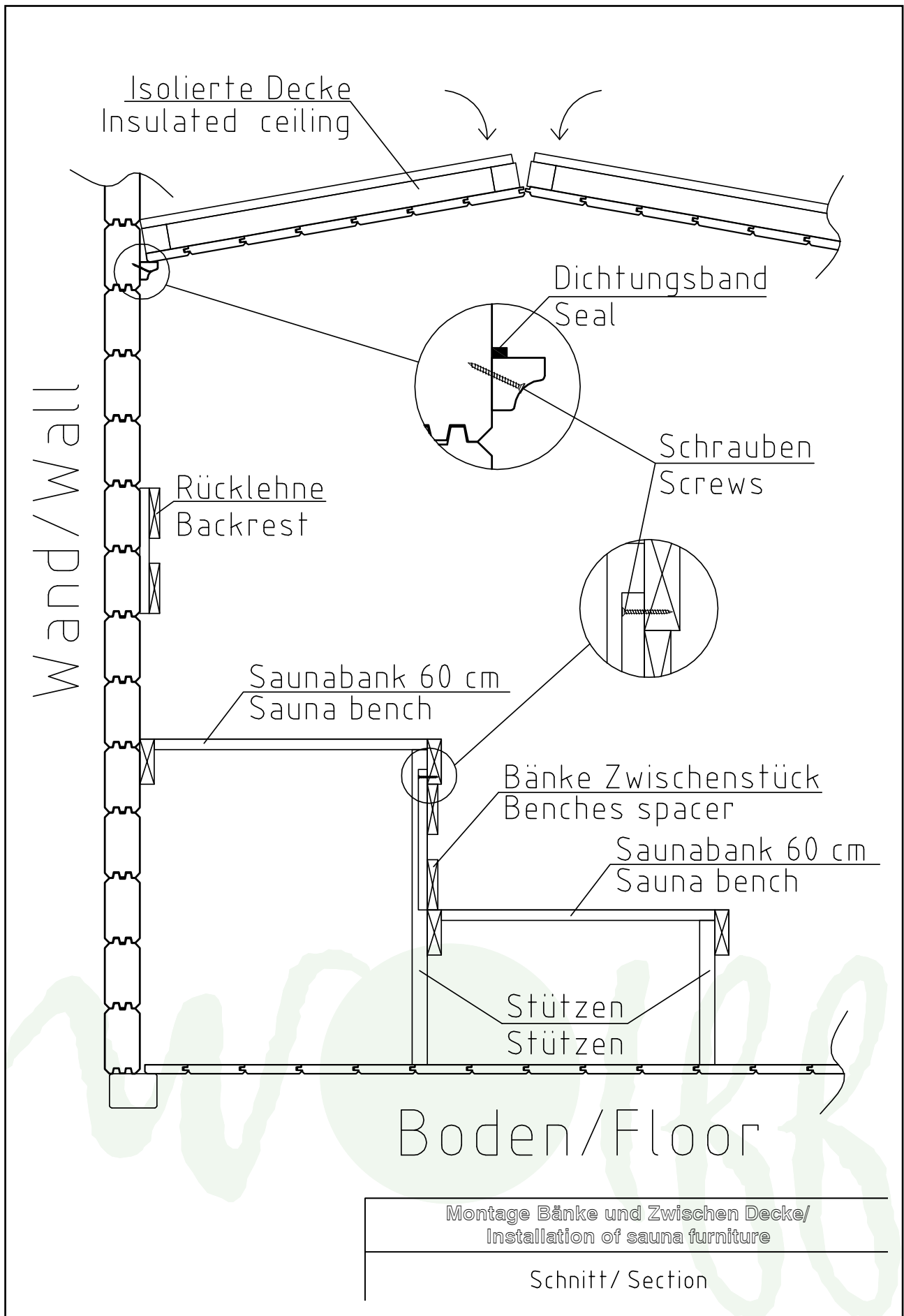

Detail

Saunahaus Sanna 70



18x90 Blendleisten/
cover strips/piirdeliistud

Rahmenleisten
20x Wandstärke/
frame extensions
20x wall thickness/
laiendusliist
20x seinä paksus

18x90 Blendleisten/
cover strips/piirdeliistud

Detail Saunahaus Sanna 70

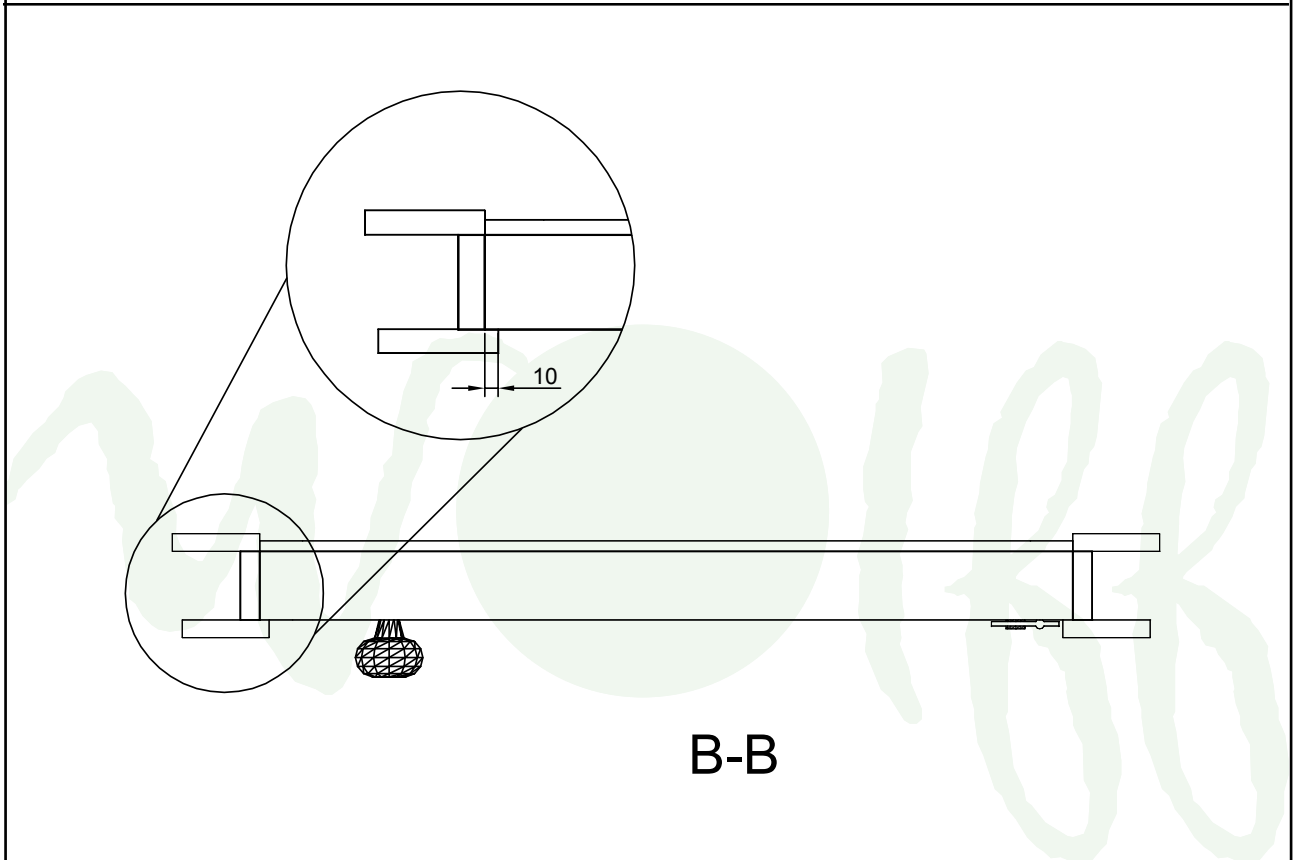
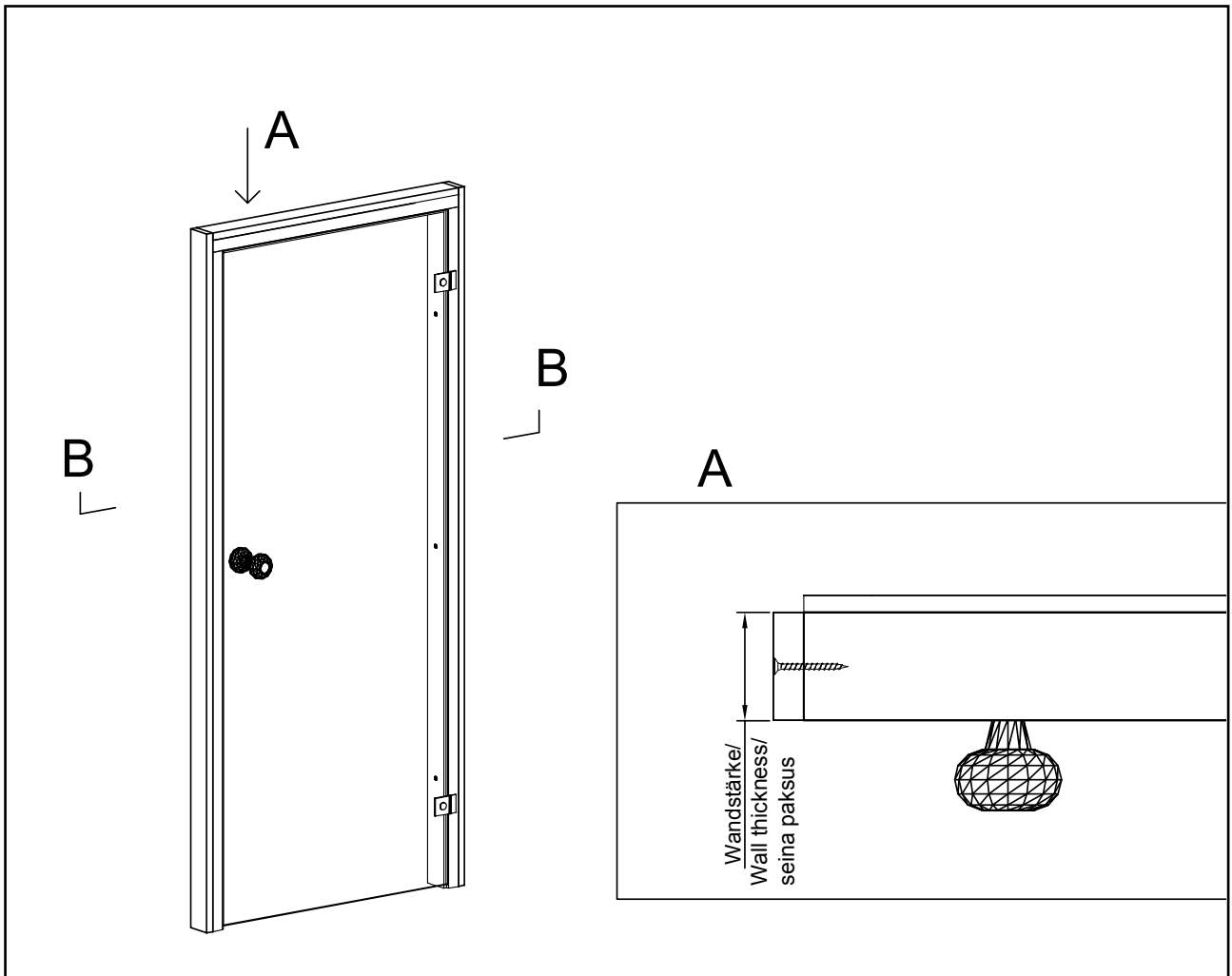

B-B

Detail Saunahaush Sanna 70

