

85978-2006



 **Aufbauanleitung**

 **montagehandleiding**





 **notice de montage**

 **Instrucciones de
construcción**







 **Building Instructions**



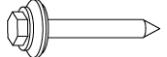

 **Service-Hotline: +49 421 38693 33**

85978-2006





				
Vergleichen Sie zuerst die Materialliste mit Ihrem Paketinhalt! Bitte haben Sie Verständnis, dass Beanstandungen nur im <u>nicht aufgebauten</u> Zustand bearbeitet werden können!	Vergelijk eerst de lijst van materialen met de inhoud van uw pakket! Reclamaties kunnen alleen in behandeling worden genomen zolang de onderdelen <u>nog niet zijn gemonteerd!</u>	Veillez d'abord comparer la liste avec le contenu du paquet! Veillez à ce que les réclamations sont exécutées uniquement en état <u>non monté !</u>	En primer lugar, compare la lista de material con el contenido del paquete. Rogamos entienda que las reclamaciones sólo pueden ser tramitadas <u>antes de montar el objeto.</u>	First, check and compare the list of materials with the contents of your package! We ask for your understanding that complaints can only be processed when the product has not been assembled!



Pos. Nr. N° N° No.	Bezeichnung Benaming Désignation Denominación Description	Länge Lengte Longueur Largo Length	Breite Breedte Largeur Ancho Width	Höhe Hoogte Hauteur Alto Height	Material Materiaal Matériel Matériel Material	Anzahl Aantal Nombre Cantidad Quantity	Nr. Art.nr. Article n° N° Art. Art. no.
4	Ständer Staander Piliers Soporte Pillars	2100	90	90	Balken Balken Poutres Viga Beam	2	38800
2	Rahmen Raamwerk Cadre Marco Frame	2400	55	115	Glatkant Gladde kant Avec bord chanfreiné Borde liso Smooth-edged	2	38796
1	Ergänzungsstücke Aanvullingsstukken Pièces complémentaires Complementos Complementary pieces	300	27,5	115	Glatkant Gladde kant Avec bord chanfreiné Borde liso Smooth-edged	4	38801
6	Sparren Dakspoor Chevrons Cabio Rafters	3000	55	115	Balken Balken Poutres Viga Beam	4	21754
7	Dachlatten Daklat Lattes de toit Listones del techo Roof laths	2400	40	60	Latten Latten Plaques Listones Laths	7	19332
8	Stirnbretter Boeiboorden Planches de rive Sofito Lateral fascia boards	3300	18	95	Glatkant Gladde kant Avec bord chanfreiné Borde liso Smooth-edged	3	22719
	Dachplatten Dakplaten Plaques de toit Tableros del techo Roof plates	3050	900	18	Wellenplatten Golfplaten Plaques ondulées Tableros ondulados Corrugated plates	3	38804
5	Kopfband Schoorbalkje Contre-fiche Cabecera Strut	380	55	115		2	16477

Beschlagbeutel: Zak met beslagwerkonderdelen: Sachet de ferrure: Bolsa de guarniciones: Bag of fixtures:						
Bezeichnung Benaming Désignation Denominación Description	Größe Maat Taille Tamaño Size				Anzahl Aantal Nombre Cantidad Quantity	Art.-Nr. Art.nr. Article n° N° Art. Art. no.
Winkel Hoekijzer Angle Ángulo Bracket	60	60	50		8	12009
Maschinenbolzen und Mutter Zeskantbout en moer Boulon mécanique et écrou Perno de máquina y tuerca Machine bolt and counternut	M12	120			2	38808
U-Scheibe Onderlegplaatje Rondelle profilée U Arandela Plain washer	13,5	44	4		8	12011
Schrauben Schroeven Vis Tornillos Screws	4	50			140	3688
	6	120			8	9205
Bohrschraube Golfplaatschroeven Tarière Tornillo perforador Drilling screw	4,2	38			160	36178
Dübel* mit Schrauben Pluggen* met schroeven Fenton* avec vis Espiga* con tornillos Dowel* with screws	16	80			4	38810
	12	160				

				
* Bitte prüfen Sie ob die mitgelieferten Dübel für Ihr Mauerwerk geeignet sind. sollte dies nicht der Fall sein, wenden Sie sich bitte an einen Baufachhandel und kaufen Sie sich dort für Ihr Mauerwerk zugelassene Befestigungen.	* Controleer of de bijgeleverde pluggen geschikt zijn voor uw metselwerk. Wanneer dit niet het geval is, begeeft u zich dan naar een bouwmarkt en koop daar bevestigingen die geschikt zijn voor uw metselwerk.	* Veuillez contrôler que les fentons livrés avec le produit sont adaptés à votre maçonnerie. Dans le cas contraire, procurez-vous auprès de votre magasin compétent les fixations autorisées et adaptées à vos murs.	* Compruebe si la espiga facilitada es adecuada para su mampostería. Si no es éste el caso, consulte en un comercio especializado y compre las fijaciones homologadas para su mampostería.	* Please check whether the dowels supplied are suited for your walling. Should this not be the case, please consult your building product dealer and purchase the attachment elements approved for your walling there.





Was wird mit was verbunden? Wat wordt waarmee verbonden? Utilisation des vis / clous? ¿Qué va unido a qué? What is joined to what?	Schraube Verbindingsmiddelen Moyen de fixation Tornillos Screws		Anzahl Aantal Nombre Ctdad Quantity
Ständer mit Rahmen Staander met raamwerk Piliers avec cadre Soporte con marco Pillar with frame	Bolzen Bouten Ecrous Perno Bolt	je 1 per 1	2
Ergänzungsstücke mit Rahmen Aanvullingsstukken met raamwerk Pièces complémentaires avec cadre Complemento con marco Complementary pieces with frame	4*50	je 4 per 4	16
Rahmen untereinander Raamwerken onderling Cadre l'un sous l'autre Marcos entre sí Frames under each other	4*50	je 4 per 4	
Rahmen Wand mit Wand Raamwerk muur met muur Cadre mur avec mur Marco pared con pared Frames wall to wall	Schraube und Dübel Schroef en plug Vis et fentons Tornillo y espiga Screw and dowel		4
Winkel mit Rahmen und Sparren Hoekijzer met raamwerk en daksporen Angle avec cadre et chevrons Ángulo con marco y cabio Bracket with frame and rafter	4*50	8 pro Winkel 8 per Hoekijzer 8 par Angle 8 por ángulo 8 per bracket	64
Sparren mit Dachlatten Daksporen met daklatten Chevrons avec lattes de toit Cabio con listones de techo Rafter with roof laths	4*50	2 pro verbinding 2 per verbinding 2 par raccordement 2 por unión 2 per connection	48
Stirnbretter Boeiboorden Planches de rive Sofitos Lateral fascia boards	4*50	je 4 per 4	16
Kopfbänder Schoorbalkjes Contre-fiches Flejes Struts	6*120	je 4 per 4	8
Dachplatten an Dachlatten Dakplaten aan daklatten Plaques de toit sur lattes de toits Tablero del techo en tablero del techo Roof plates to roof laths			

				
Werkzeugbedarf: Bohrer, Bohrmaschine, Akkuschrauber, div. Bits, Maulschlüssel oder Steckschlüsselaufsätze, Säge, Wasserwaage, Maßband,	Benodigd gereedschap: boortje, boormachine, accuschroefmachine, div. bitjes, steeksleutel of steeksleutelopzetstukke n, zaag, waterpas, meetlint,	Outillage nécessaire : Mandrin, perceuse, tournevis sans fil, divers bits, clé à fourche simple ou jeu de clés à douille, scie, niveau à bulle, décamètre à ruban	Herramientas necesarias: broca, taladradora, atornilladora mecánica con acumulador, bits diversos, llave de boca o vasos, sierra, nivel de albañil, metro.	Required tools: Drill, machine drill, accu screwdriver, various drill bits, open-jawed spanner or hexagonal spanner fittings, saw, spirit gauge, tape measure

				
Das von Ihnen erworbene Produkt gibt es in 3 verschiedenen Tiefen und es ist seitlich beliebig weit erweiterbar. Aus diesem Grund erhalten Sie, wenn Sie die kleinste Breite erworben haben nur das Grundpaket (1 Feldbreite). Jede breitere Variante setzt sich dann aus diesem Grundpaket und der entsprechenden Anzahl aus Verlängerungspaketen (je Feld 1 Stk) zusammen.	Het door u gekochte product is verkrijgbaar in 3 verschillende breedtes en kan aan de zijkant willekeurig ver worden verbreed. Om die reden ontvangt u, wanneer u de kleinste breedte heeft gekocht, slechts het basispakket (1 veldbreedte). Eedere bredere variant bestaat vervolgens uit dit basispakket en het desbetreffende aantal verlengingspakketten (per veld 1 stuk).	Le produit que vous venez d'acquérir est disponible en 3 profondeurs différentes et peut être agrandi à volonté. C'est pourquoi vous ne recevez que la plus petite largeur si vous avez acheté le produit de base (1 dimension). Chacune des variantes plus larges est composée du produit de base et du nombre approprié d'éléments complémentaires (1 élément par dimension).	El producto que usted ha adquirido está disponible en 3 profundidades y puede ampliarse lateralmente a discreción. Por este motivo, si usted ha adquirido el ancho menor solamente recibe un paquete base (1 ancho de campo). Cualquier otra variante parte de este paquete y se ha de unir la cantidad correspondiente de paquetes de prolongación (1 pieza por campo).	The product you have acquired is available in three different depths and can be laterally extended to any arbitrary width. For this reason, if you have purchased the smallest width you will have only the basic package (one cubicle width). Each wider variant is then comprises this basic package and the required number of extension packages (one cubicle width element per package).
Sie sollten jedes Paket anhand der beigelegten Stückliste auf Vollständigkeit überprüfen. Die Anleitung ist in jedem Paket identisch.	U dient aan de hand van de bijgevoegde stuklijst te controleren of ieder pakket volledig is. De handleiding is in ieder pakket gelijk.	A l'aide de la liste d'articles ci-jointe, contrôlez l'intégralité des pièces contenues dans chaque colis. La notice de montage est identique dans chaque colis.	Controle que los paquetes estén completos de conformidad con la lista de elementos adjunta. Las instrucciones son idénticas en todos los paquetes.	Control each package for completeness according to the enclosed piece list. The instructions in each package are identical.
Hier ist eine Tabelle zur besseren Orientierung welche Pakete Sie erhalten haben:	Hier is een tabel waardoor u zich beter kunt oriënteren, welke pakketten u heeft ontvangen:	Le tableau ci-joint vous servira à mieux identifier les colis que vous venez d'acquérir.	Aquí hay una tabla para la mejor orientación sobre el paquete que usted ha recibido:	Here is a table for orientation, to show you which package you have acquired.

Tiefe Terrassenüberdachung in cm (Zirkmaß) Breedte terrasoverdekking in cm (afmetingen bij benadering) Profondeur Préau en cm (mesure approximative) Profundidad Techo de la terraza en cm (medida aproximada) Deep terrace roofing (approximate size)	240	300	365
Nummer Anleitung Grundpaket Nummer handleiding basispakket Número de notice de montage Colis de base Número de instrucción paquete base Number of instruction leaflet in basic package	85953	85978	85979
Nummer Anleitung Verlängerungspaket Nummer handleiding verlengingspakket Número de notice de montage Extension Número de instrucción paquete de prolongación Number of instruction leaflet in extension package	85980	85981	85982

Abb./Fig.					
1-1 – 1-2	Die Positionen 1-3 miteinander verschrauben, so dass Sie 2 gleiche Balken erhalten.	Schroef de onderdelen 1-3 aan elkaar vast, zodat u 2 gelijke balken krijgt.	Fixer ensemble les positions 1-3 afin d'obtenir 2 poutres identiques.	Atornillar entre sí las posiciones 1 – 3, de tal forma que usted obtenga 2 vigas iguales.	Join items 1-3 with screws, so that you have two identical beams.
1-3 – 1-5	Die Ständer mit den Balken verbinden (1-5). Die Kopfbänder anschrauben. Achten Sie dabei auf einen Rechten Winkel zwischen den Balken und den Ständern.	Verbind de staanders met de balken (1-5). Schroef de schoorbalkjes vast. Let er daarbij op, dat er een rechte hoek tussen de balk en de staander ontstaat.	Fixer les montants aux poutres (1-5). Visser les contrefiches. Veillez à ce que les poutres et les piliers soient à angle droit.	Una los soportes con las vigas (1-5). Atornillar los flejes. Preste atención al ángulo recto entre las vigas y los soportes.	Connect the pillars to the beams (1-5). Attach the struts. Make certain that the beams and the pillars are at right angles to each other.
2-1	Befestigen Sie einen Balken lt. Zeichnung an Ihrer Mauer. Stellen Sie die Ständer mit Hilfe von z.B. Pfostenanker auf.	Bevestig één balk volgens de tekening aan uw muur. Plaats de staanders met behulp van bijv. paalankers rechtop.	Fixez une poutre au mur selon l'illustration. Installez les piliers à l'aide d'un ancrage pour montant par ex.	Fije una viga según el dibujo a su pared. Coloque los soportes con ayuda del anclaje de postes.	Attach a beam to your wall as shown in the drawing. Set up the pillars, e.g. with the aid of stay anchors.
2-2 – 2-3	Legen Sie die Sparren in gleichmäßigen Abständen auf und verschrauben Sie diese mit Hilfe der Winkel.	Plaats de daksporen met gelijkmatige afstanden en schroef deze vast met behulp van de hoekijzers.	Disposez les chevrons à intervalles réguliers et fixez-les à l'aide d'angles.	Coloque los cabios a distancias iguales y atorníllelos con ayuda del ángulo.	Place the rafters uniformly spaced and screw down with the aid of the brackets.
	Wenn Sie an Ihre Terrassenüberdachung Seitenwände mit Giebelelement montieren wollen, müssen Sie dies jetzt vor der Montage des Daches machen.	Wanneer u aan uw terrasoverdekking zijwanden met een gevelelement wilt monteren, moet u dit nu doen alvorens het dak te monteren.	Si vous avez prévu de monter des parois latérales avec pignon avec votre préau, faites-le maintenant, préalablement au montage du toit.	Si usted monta paredes laterales con frontón al techo de su terraza, hágalo ahora antes de montar el techo.	If you wish to mount side walls with gable elements on your terrace roofing, you must do this now before installing the roof.
3-1	Legen Sie die Dachlatten in gleichmäßigen Abständen auf, wenn Sie Verlängerungspakete haben. müssen Sie diese so einkürzen, dass der Stoß zwischen 2 Leisten sich mittig auf einem Sparren befindet.	Leg de daklatten met gelijkmatige tussenruimtes op de sporen. Wanneer u verlengingspakketten heeft, moet u deze zodanig inkorten, dat de naad tussen 2 latten zich in het midden op een dakspoor bevindt.	Posez les lattes de toit à intervalles réguliers. Si vous disposez d'extensions, raccourcissez-les de manière à ce que la jointure entre 2 lattes se trouve au milieu d'un chevron.	Coloque los listones del techo a distancias iguales. Si tiene un paquete de prolongación, acórtelas de tal modo que los dos listones choquen centradamente en un cabio.	Lay the roof battens uniformly spaced. If you have extension packages, you must shorten these so that the joint between two lath sections is at the centre of the rafter.
3-2	Die seitlichen Stirnbretter anbringen. Sie sollten mindestens 2 cm den Dachlatten nach oben überstehen. Danach bringen Sie die vorderen Stirnbretter an, diese sollten oben bündig mit den Dachlatten sein.	Breng de boeiboorden aan de zijkant aan. Deze dienen ten minste 2 cm boven de daklatten uit te steken. Vervolgens brengt u de boeiboorden aan de voorzijde aan. Deze dienen aan de bovenzijde gelijk met de daklatten te lopen.	Installez les planches de rive latérales. Elles doivent dépasser les lattes de toit d'au moins 2 cm vers le haut. Montez ensuite les planches de rives de devant qui doivent être affleurées avec les lattes de toit.	Colocar los sofitos laterales. Éstos han de sobresalir, al menos, 2 cm de los listones del techo. Posteriormente coloque los sofitos delanteros. Éstos han de estar a ras de los listones.	Mount the lateral fascia boards. These must project at least 2 cm above the roof lath sections. Then mount the front fascia boards. These must be flush with the top of the roof lath sections.
3-3	Die Dachplatten überlappend auflegen. Die Überlappung ist mit 2 Wellenüberdeckungen auszuführen.	Leg de golfplaten overlappend op het dak. De golfplaten dienen elkaar 2 golven te overlappen.	Poser les lattes de toit en les faisant se chevaucher. Le chevauchement doit être effectué avec 2 couvertures ondulées.	Colocar los tableros del techo solapadamente. Realizar el solapamiento con 2 sobrepuentes ondulados.	Lay on the roof plates overlapping. The overlap must be covered over with two corrugated pieces.

Abb./Fig.					
3-4	<p>Die Platten sind in jedem 3. Wellenboden zu verschrauben. (6-2) In den äußeren Randfeldern jedoch in jedem Wellenboden sowie in der Überlappung. Schrauben Sie bis die Gummidichtung fest an der Platte liegt.</p> <p>Die Löcher in den Dachplatten werden in der Mitte der Welle mit einem Holzspezialbohrer gebohrt. Bitte Beachten Sie , dass das Bohrfutter die Dachplatte nicht beschädigt. Die Schrauben müssen rechtwinklig in die Latten montiert werden.</p>	<p>De platen dienen in elk 3e dal van de golfplaat te worden vastgeschroefd. (6-2) In de buitenste randvlakken echter in ieder dal van de golfplaat alsmede in de overlapping vastschroeven. Schroef vast totdat de rubberafdichting stevig tegen de plaat aanligt.</p> <p>De gaten in de dakplaten worden in het midden van de golf met een speciaal houtboortje geboord. Let er a.u.b. op, dat de boorhouder de dakplaat niet beschadigt. De schroeven moeten haaks in de latten worden gemonteerd.</p>	<p>Visser les plaques sur toutes les 3 planches ondulées (6-2). Aux extrémités, visser chaque planche ondulée ainsi que le chevauchement. Vissez jusqu'à ce que la rondelle de caoutchouc soit solidement fixée à la plaque.</p> <p>Percer les trous des plaques de toit dans le milieu de l'ondulation avec une mèche spéciale bois. Veillez à ce que le mandrin n'abîme pas la plaque de toit. Les vis doivent être fixées à angle droit dans les lattes.</p>	<p>Atornillar los tableros en cada tercera base ondulada. (6.-2) En los campos de bordes exteriores hay que atornillar en cada base ondulada y en el solapamiento. Atornille hasta que la junta de goma se encuentre fija junto al tablero.</p> <p>Los agujeros de los tableros del techo se taladran en el centro con una taladradora especial para madera. Cerciórese que el portabrocas no dañe el tablero del techo. Montar los tornillos en ángulo recto en los listones.</p>	<p>Screw down the plates in every third corrugated base (6-2), however at the outer edges in every corrugated base and in the overlapping. Tighten the screws until the rubber seal lies firmly on the plate.</p> <p>Drill the holes in the roof plates in the centre of the corrugation with a special wood drill. Please note that the drill chuck does not damage the roof plate. The screws must be driven vertically into the lath sections.</p>

2x

1 x 85953/85978/85979



Abb.1-2

1 x 85953/85978/85979 + 1 x 85980/85981/85982



1 x 85953/85978/85979 + 2 x 85980/85981/85982

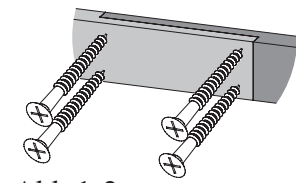
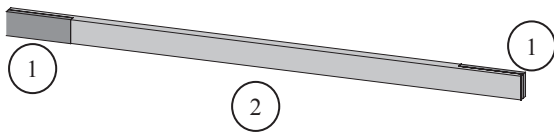
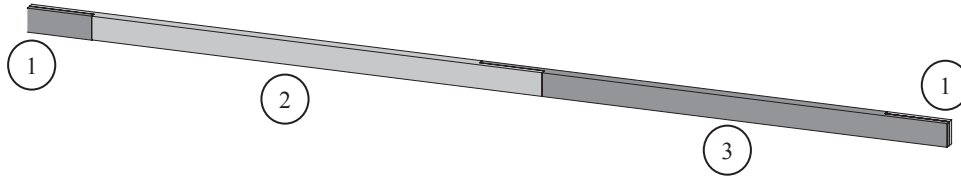

Abb.1-1



Abb.1-4

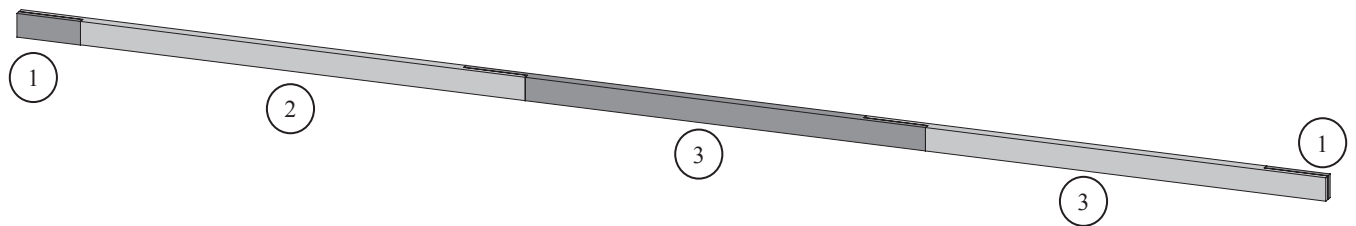

Abb.1-5

1 x 85953/85978/85979

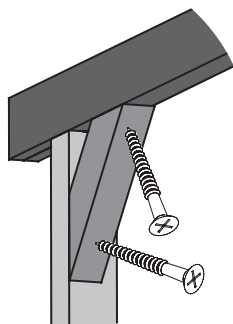
1 x 85980/85981/85982

1 x 85980/85981/85982

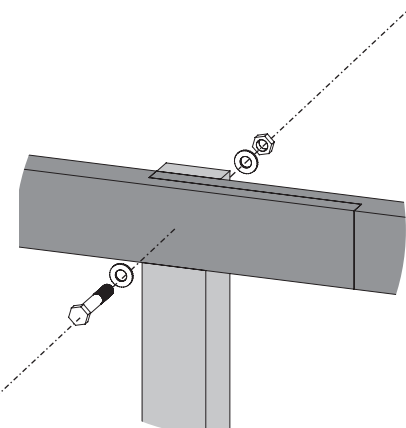

Abb.1-3





Abb.3-1

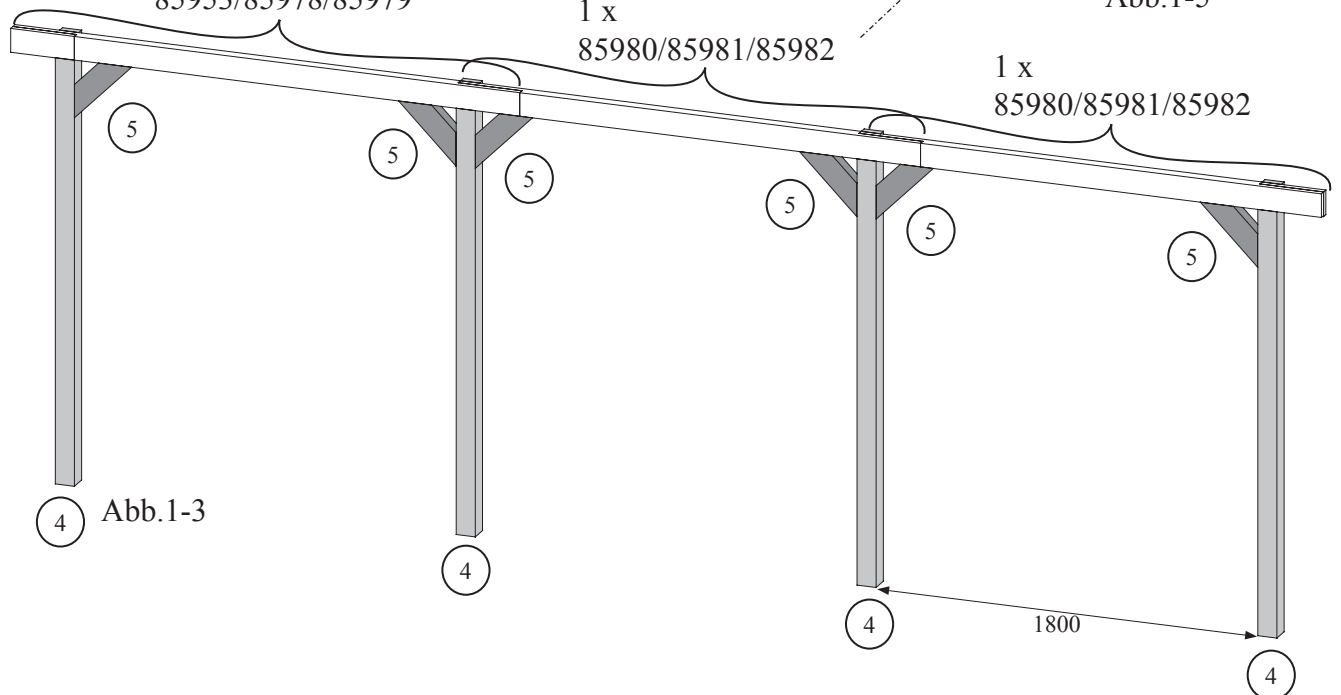
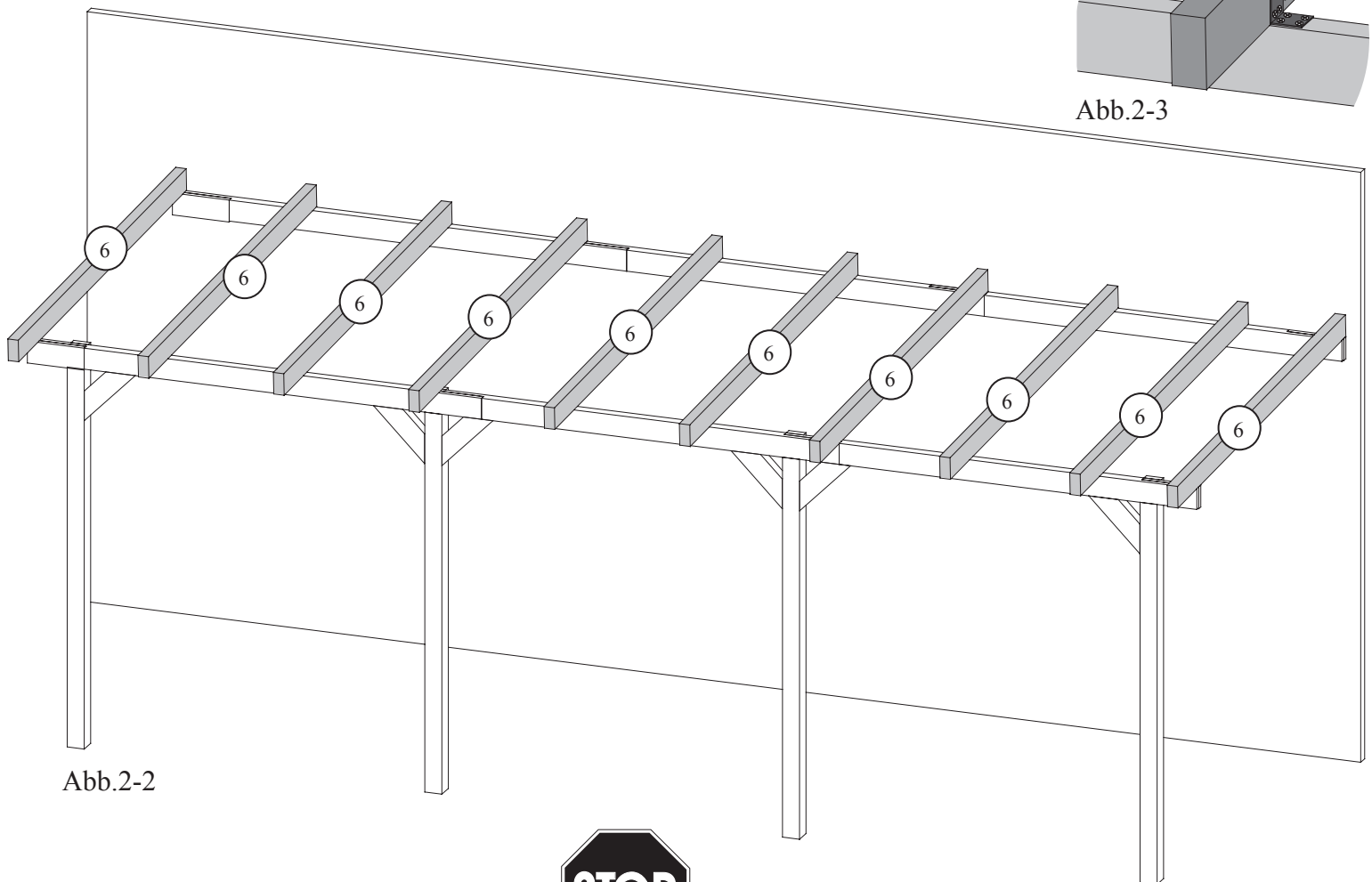
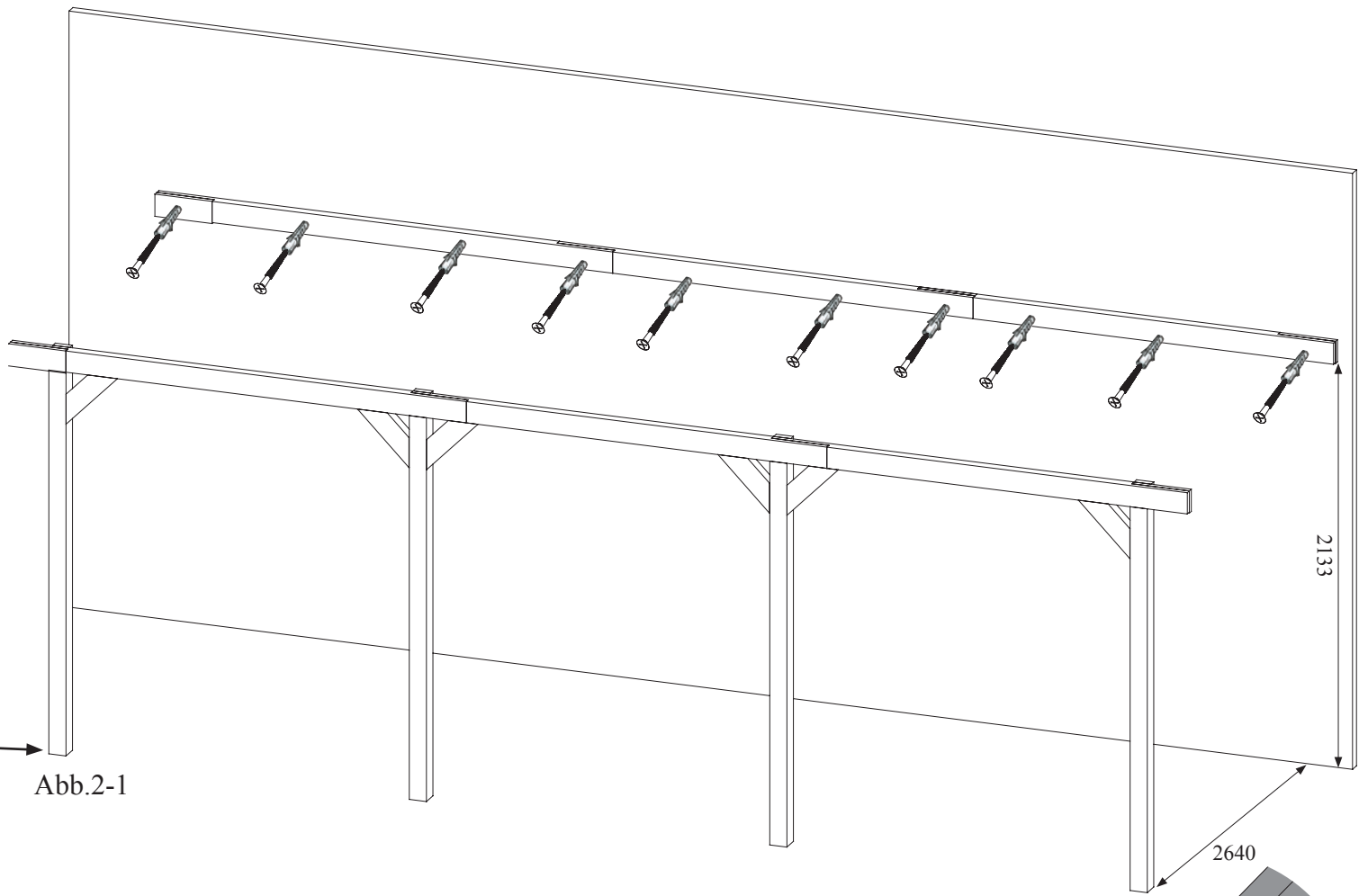

Abb.3-2

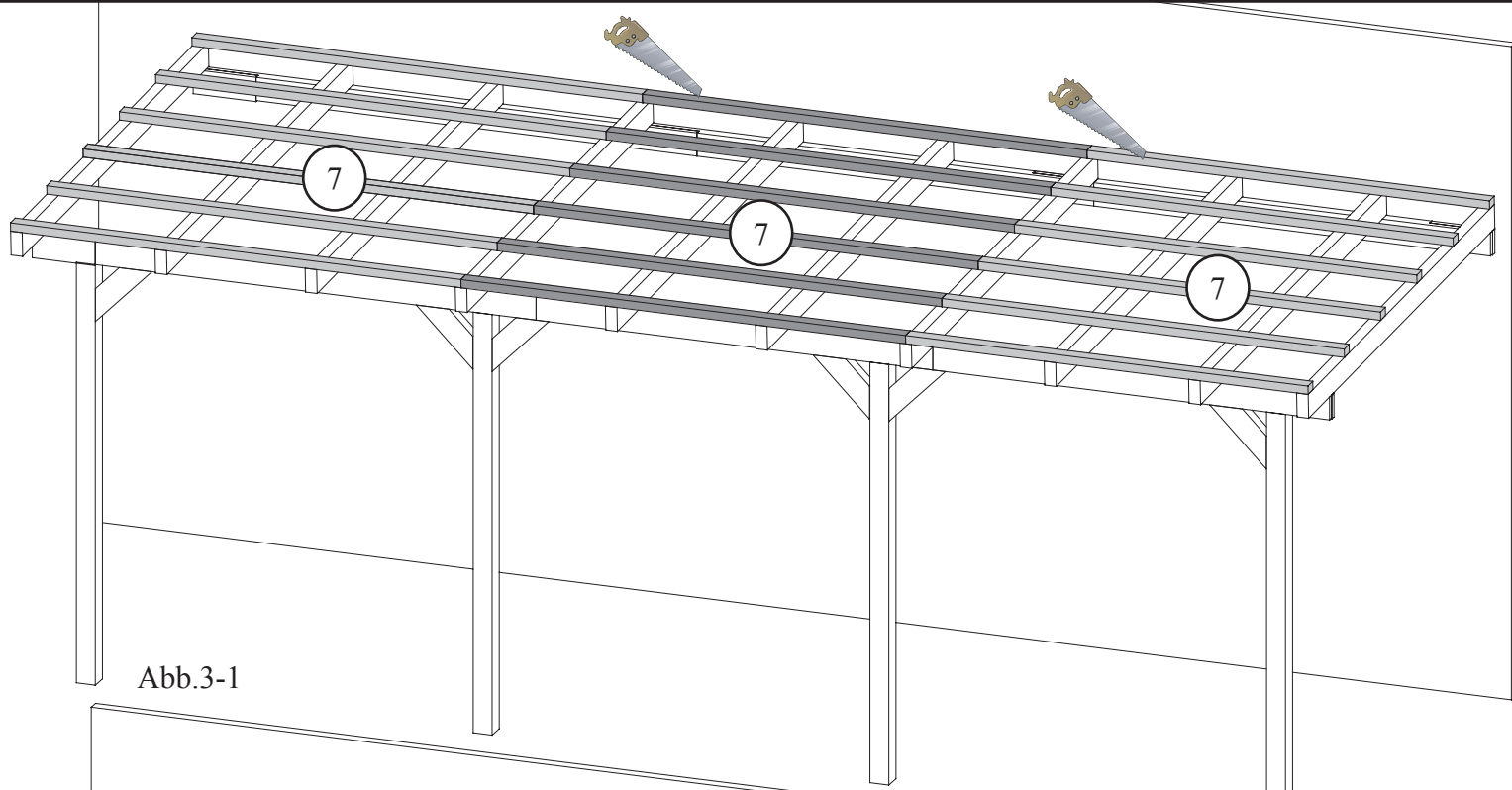

Abb.3-3

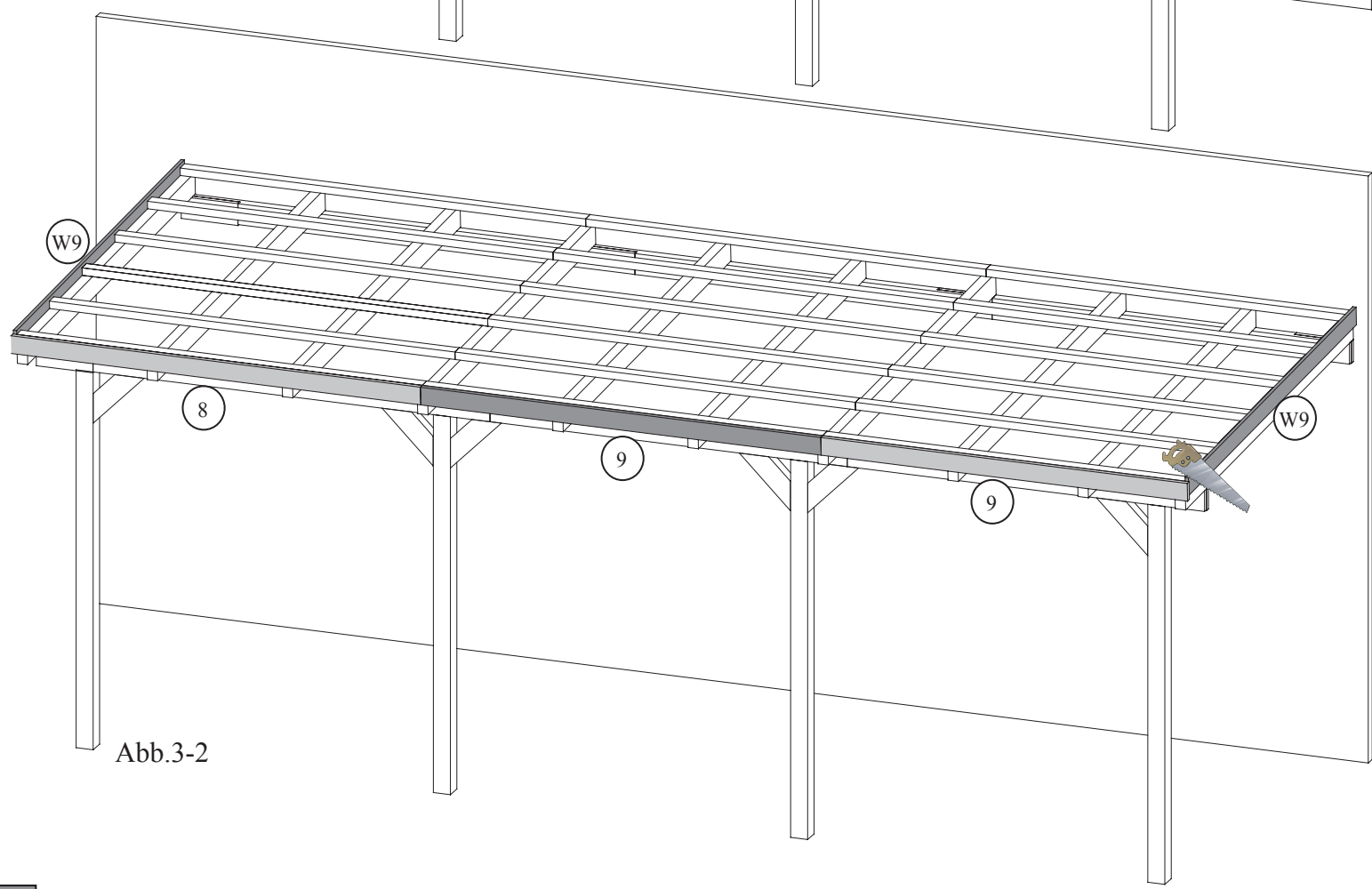

Abb.3-4

1 x 85978

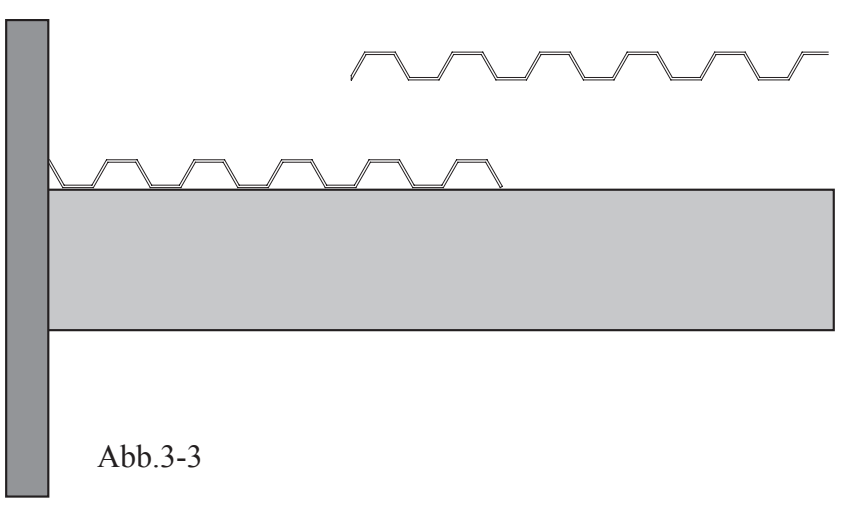
1 x 85978 + 1 x 85981

1 x 85978 + 2 x 85981

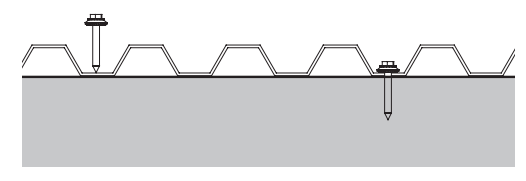
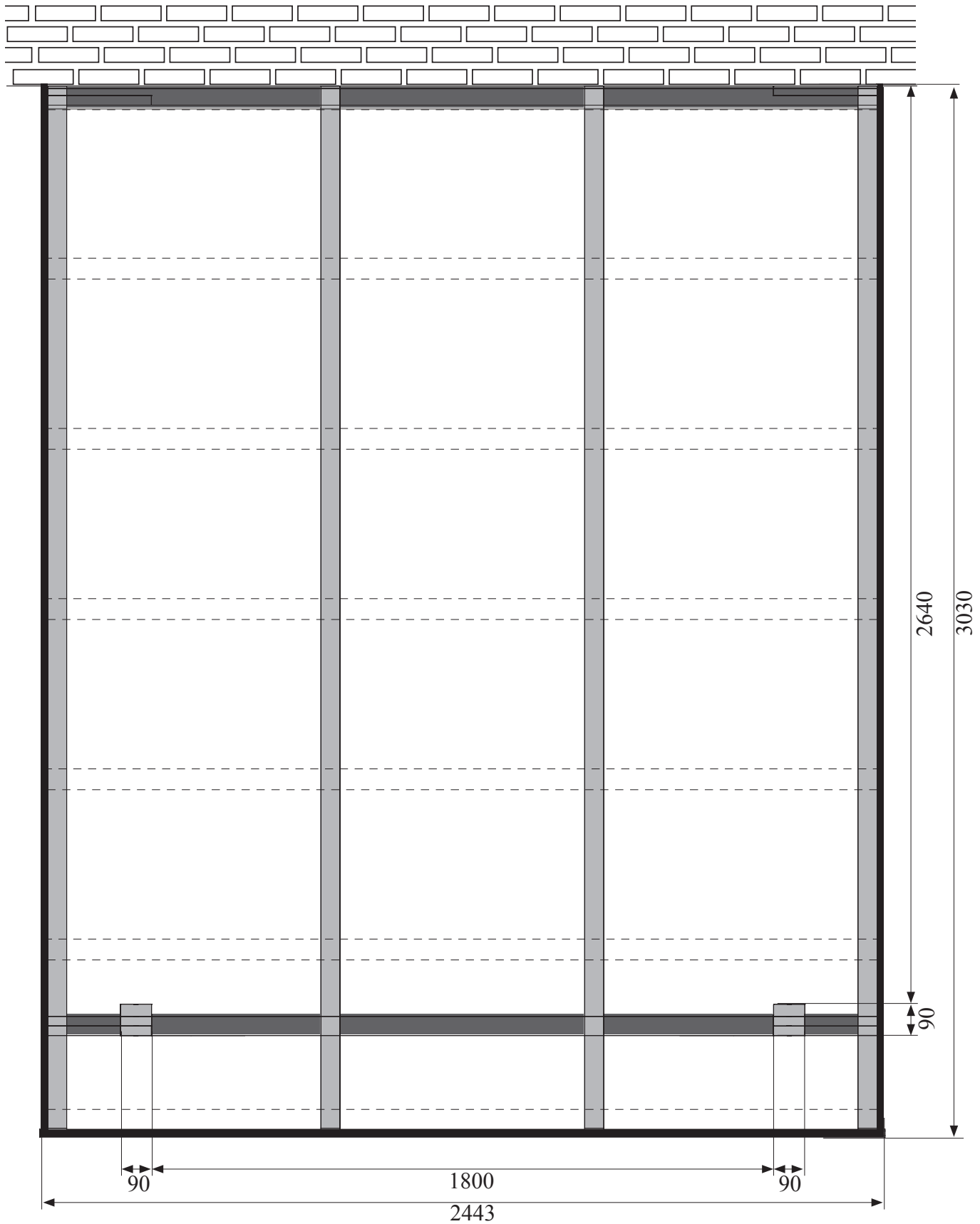
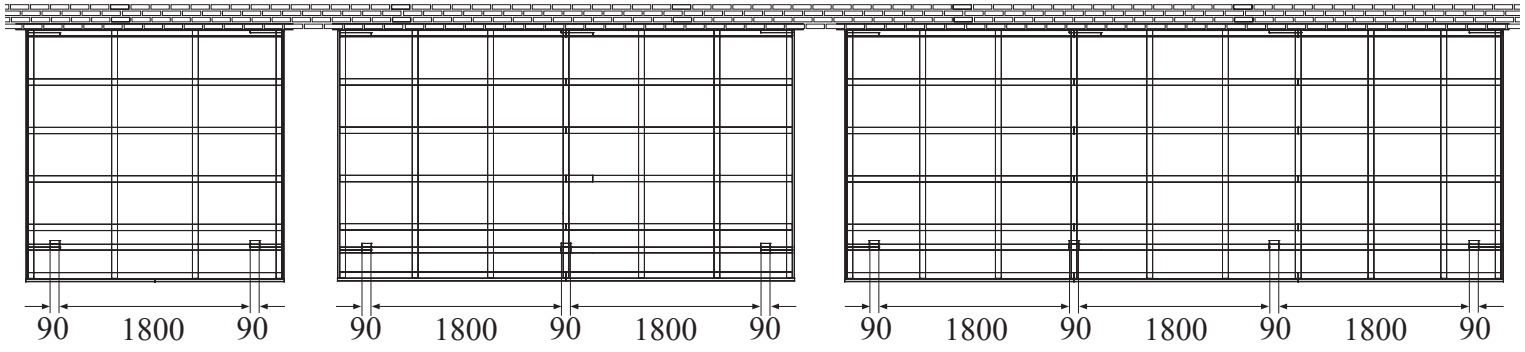

Lagerung

Prüfen Sie genau Ihre gelieferte Ware, spätere Reklamationen können nicht anerkannt werden.

Bitte beachten Sie diese Lagerungs- und Verarbeitungshinweise. Bei Nichteinhalten keine Reklamationsansprüche!

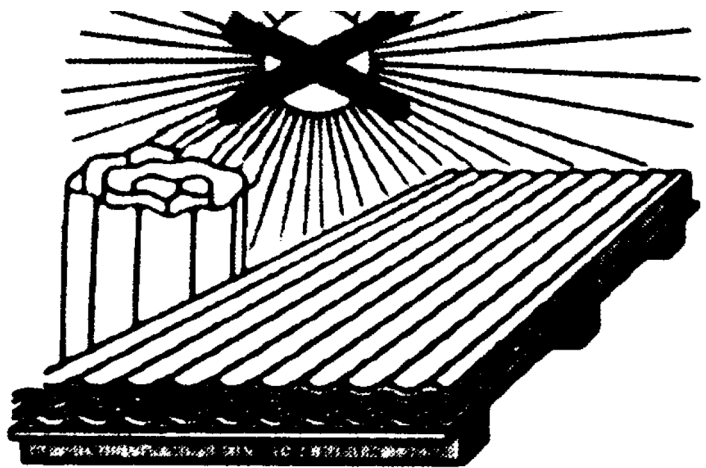

- Hitzestau und Nässe vermeiden.
- PVC-Tafeln dürfen im Stapel nicht dem Sonnenlicht und der Feuchtigkeit ausgesetzt werden. Es besteht Gefahr der Überhitzung (Brennglaswirkung!).
- Die maximale Lagerungstemperatur im Stapel darf 60°C nicht überschreiten. Für Brennglasschäden übernehmen wir keine Haftung.
- Auf ebener, nicht aufgeheizter Unterlage lagern und mit licht- und wasserundurchlässigen hellen Planen abdecken.
- Stapelhöhe max 50 cm
- Max Raumtemperatur: 40°C
- Während der Lagerung müssen PVC-Tafeln von Witterungseinflüssen, Verschmutzung und mechanischen Belastungen geschützt werden.

Montage

- Nicht bei Temperaturen unter 5°C durchführen.
- Montagebedingte manuelle Transporte einzelner Platten nicht bei Wingschwindigkeit über 3m/s durchführen.

Reinigung

- Der Reinigungszyklus ist abhängig vom Verschmutzungsgrad, sollte jedoch von außen mindestens einmal jährlich erfolgen.
- Verschmutzungen mit Wasser oder Haushaltsreinigungsmitteln beseitigen.
- Keine scheuernden, ätzenden oder lösungsmittelhaltigen Zusätze verwenden.