

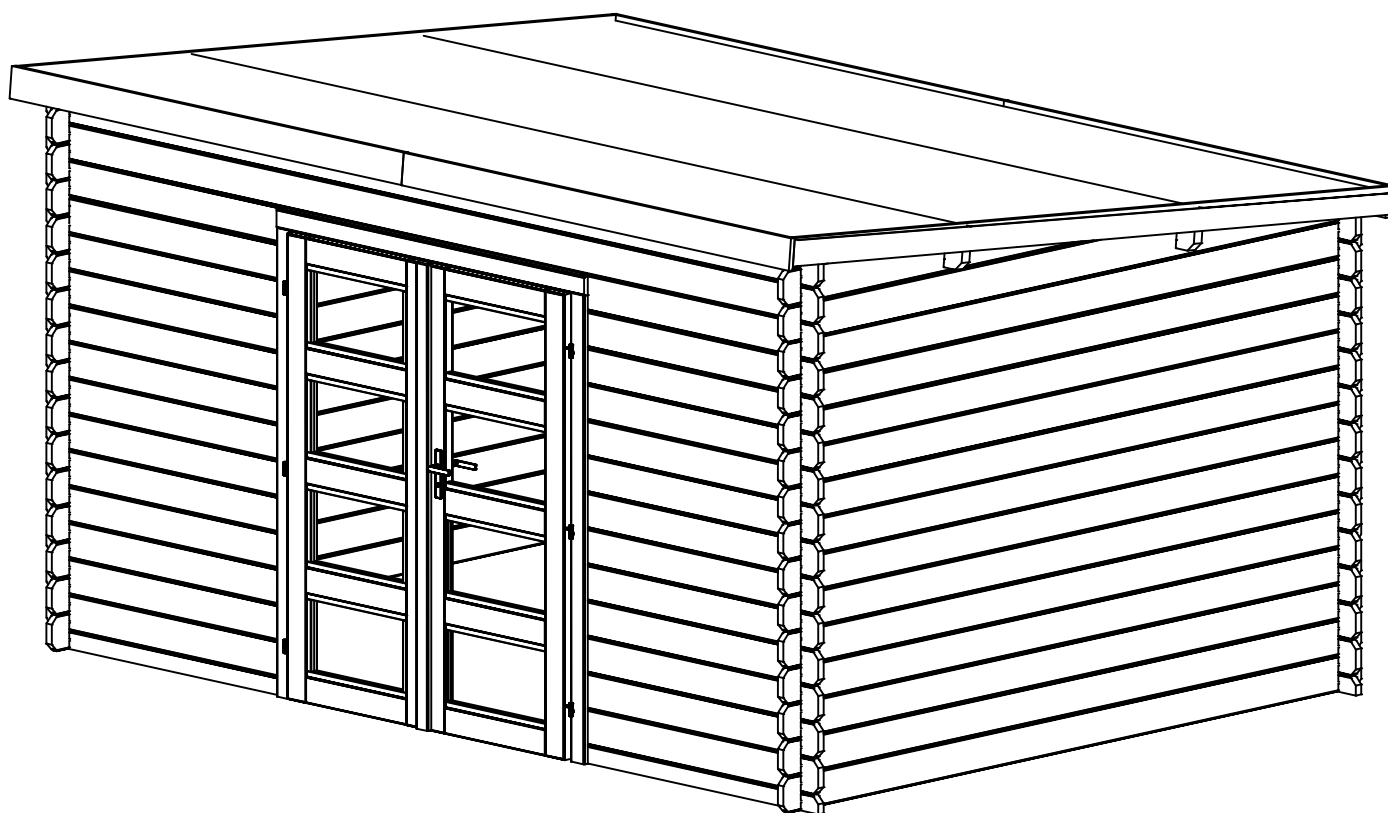

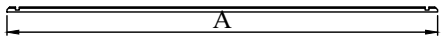

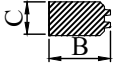

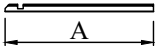

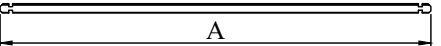

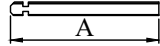
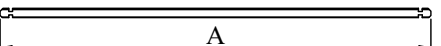
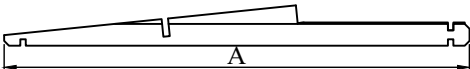
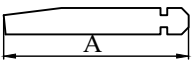
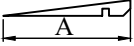
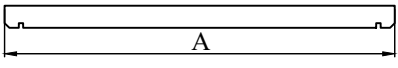

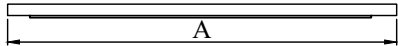
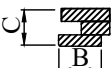
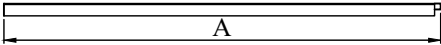
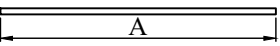
**MONTAGEANLEITUNG**  
**JANIS L7151295**  
**3.98 x 2.88 (34 mm)**

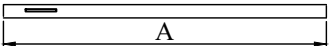

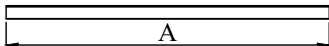
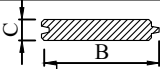
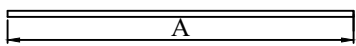

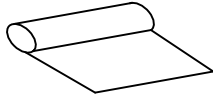
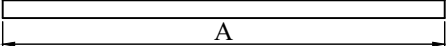
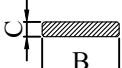
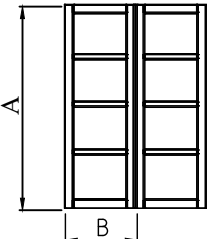

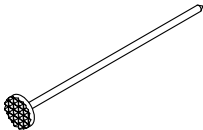
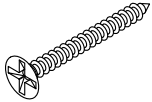
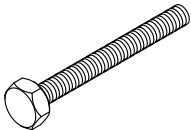

Bevor Sie mit der Montage Ihr Gartenhaus beginnen, lesen Sie bitte sorgfältig unsere Anleitung durch. Sie ersparen sich viel Zeit. Wir empfehlen Ihnen alle Einzelteile zu kontrollieren und dann unsere Anleitung, Schritt für Schritt, folgen. Wir wünschen Ihnen viel Spaß und Freude mit Ihrem neuen Gartenhaus.

# STÜCKLISTE

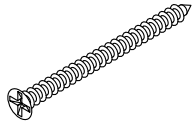
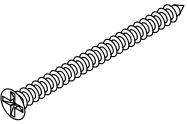
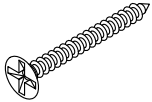
Pos.	Menge	Dimension, mm			Details	
		A	B	C		
A1.1	x1	3980	67.5	34		
A1.2	x2	1230	67.5	34		
A2	x 15+1	3980	135	34		
A3	x 26	1230	135	34		
A4	x 26 (+1)	2880	135	34		
1	x 2	2880	249/65	34		
2	x 2	1035	135/144	34		
3	x 2	873	89/0	34		
4	x 2	3980	40	120		
B1	x 1	1624	90	72		
B2	x 1+1	1785	90	72		
B3	x 1	1420	30	30		
5.1	x 2	1980	40	16		
5.2	x 2	1870	40	16		
6	x 44 + 2	2980	90	17		
7	x 4	1990	30	30		
8	x 1	10 m	1 m			
	x 1	5 m	1 m			
	x 1	5 m	0.5 m			
9.1	x 4	2010	90	19		
9.2	x 2	2980	90	19		
10.1	x 1+1	1740	715	30		
10.2	x 1	1740	75	19		

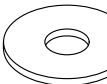
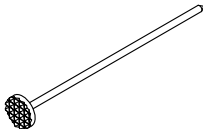
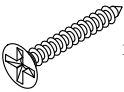
# STÜCKLISTE

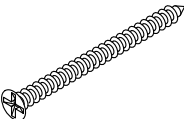
2 x 40 mm	4 x 40 mm	6 x 60 mm	M6	6 x 160 mm
 x 190	 x 58	 x 4	 x 4	 x 6
5 x 70 mm	4 x 30 mm	AH9213	M6	2 x 20 mm
 x 12	 x 36	 x 1	 x 8	 x 270
3 x 20 mm	WRO50		5 x 90 mm	
 x 12	 x 2	 x 6	 x 6	

# Montage der Wände und Türahmen

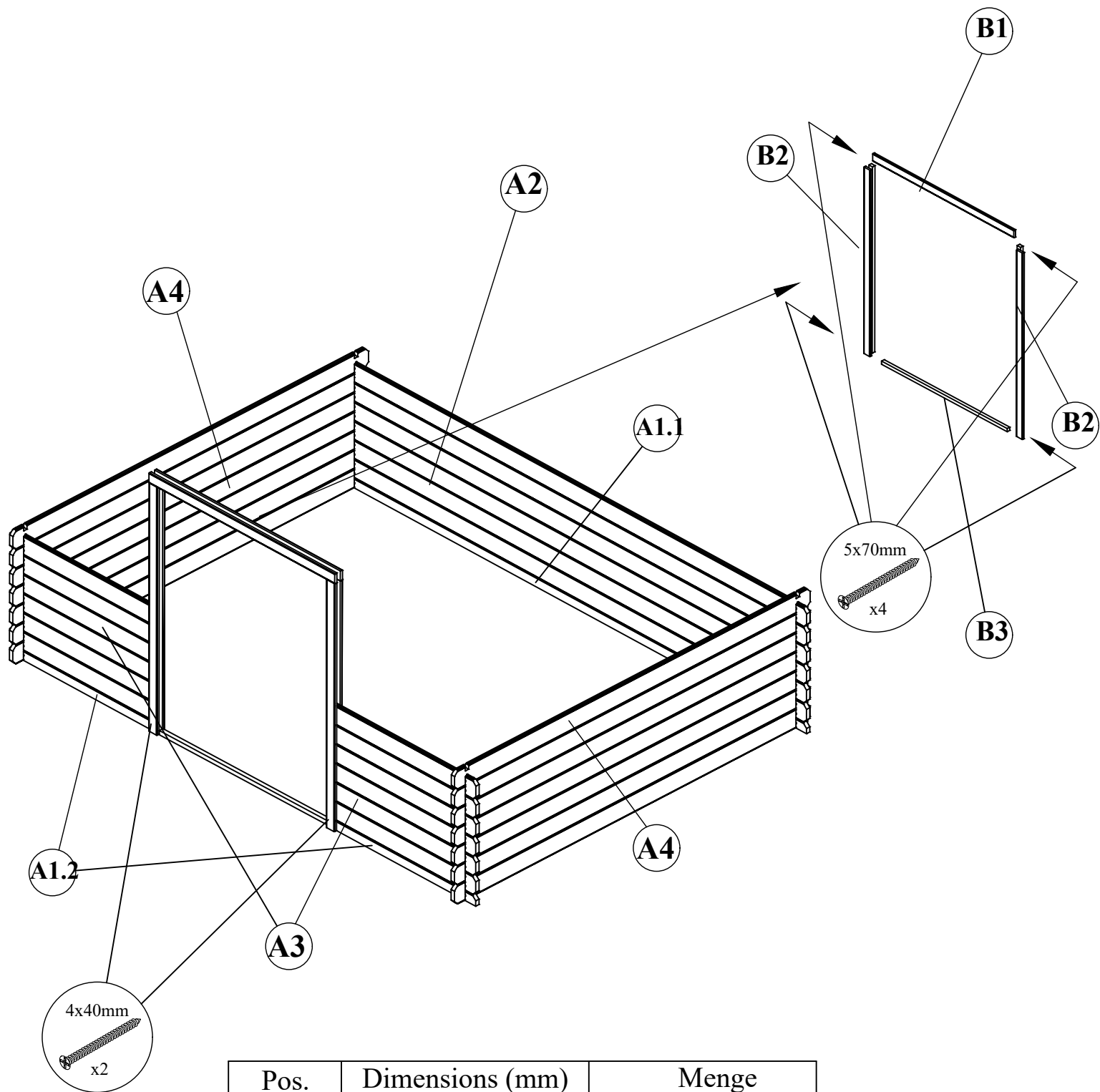

Pos.	Dimensions (mm)	Menge
A1.1	3980 x 67.5 x 34	1
A1.2	1230 x 67.5 x 34	2
A2	3980 x 135 x 34	13+1
A3	1230 x 135 x 34	26
A4	2880 x 135 x 34	26+1
B1	1624 x 90 x 72	1
B2	1785 x 90 x 72	2
B3	1420 x 30 x 30	1

# Montage der Obere Seite der Wände

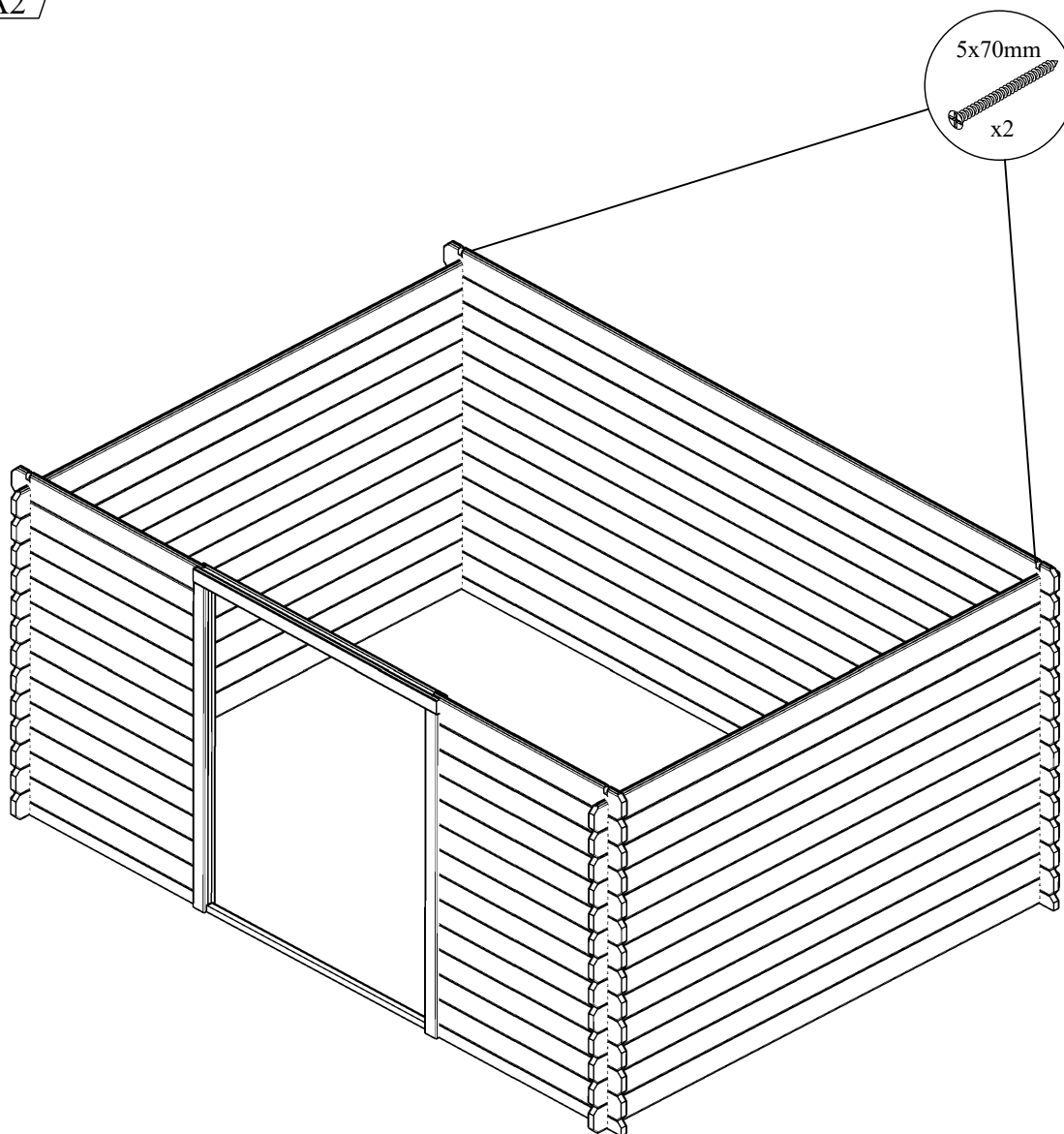
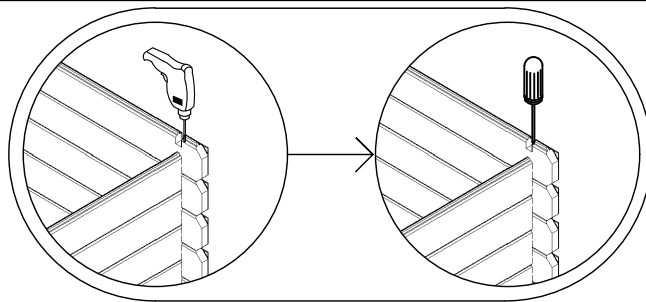
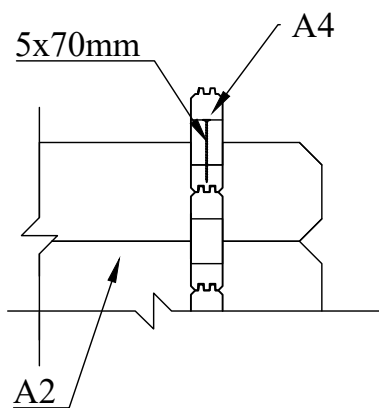

# Montage der Giebels

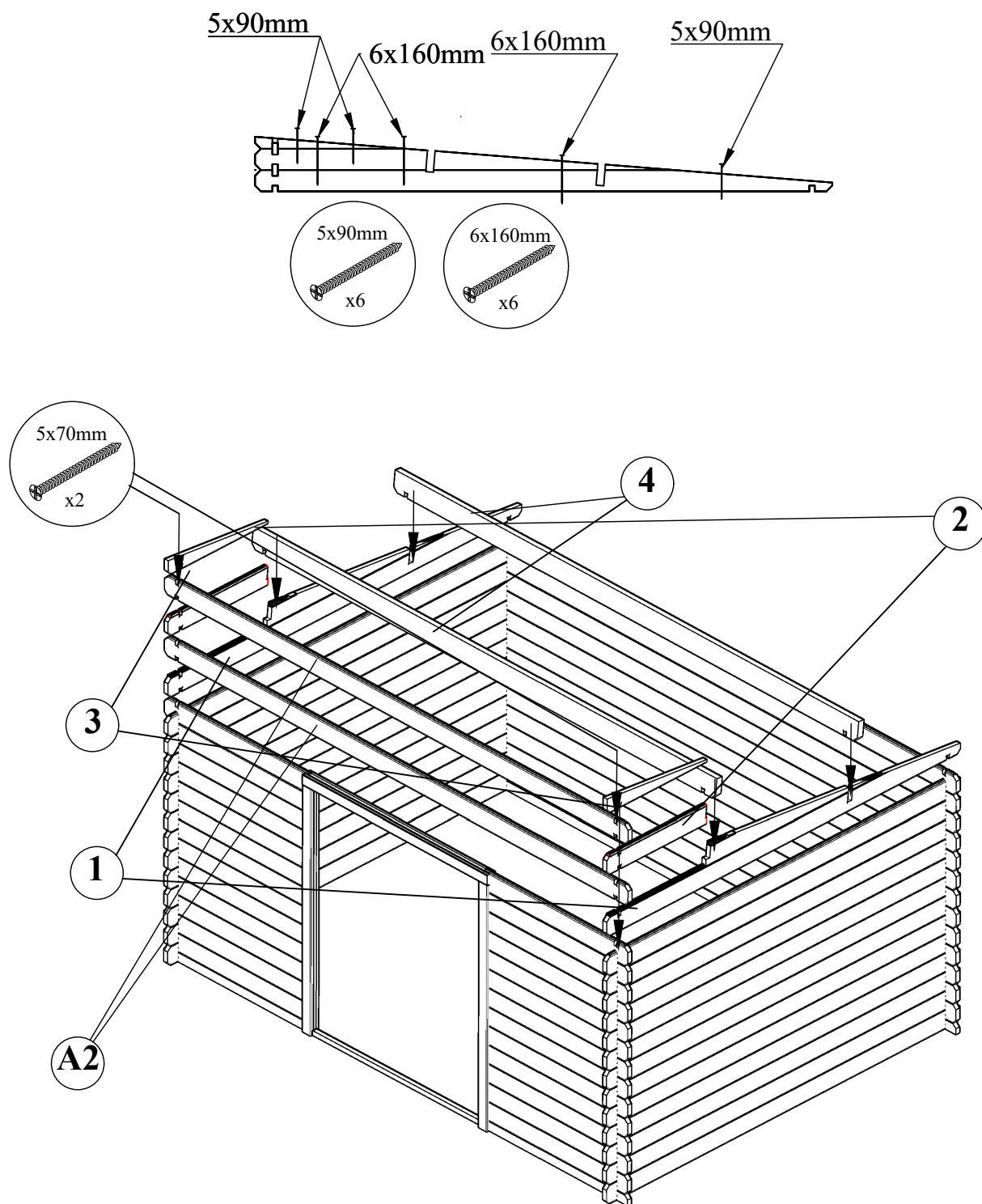

Pos.	Dimensions (mm)	Menge.
A2	3980 x 135 x 34	2
1	2880 x 249/65 x 34	2
2	1035 x 135/144 x 34	2
3	873 x 89/0 x 34	2
4	3980 x 120 x 40	2

# Montage der Dachbalken

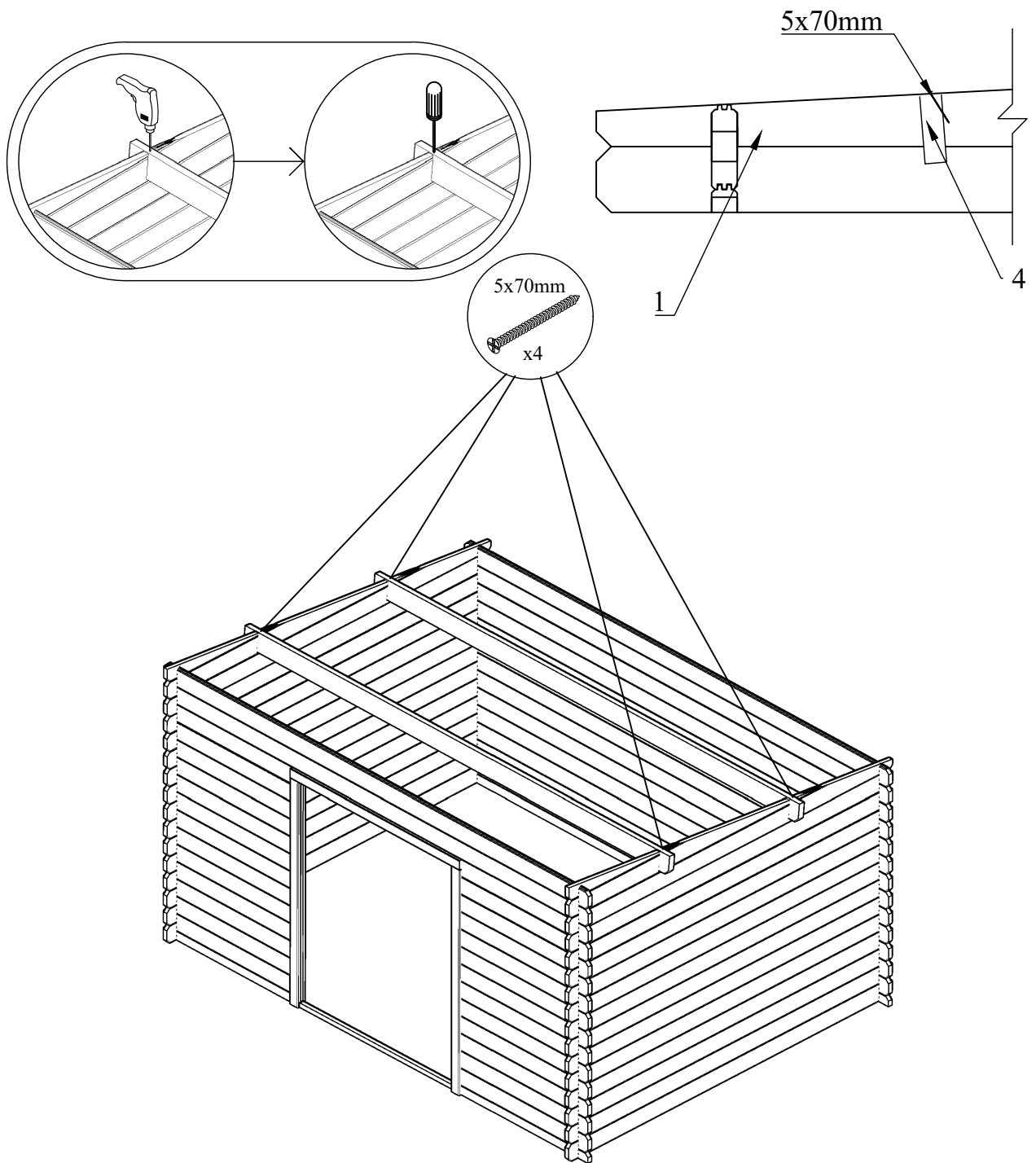

# Montage der Sturmsicherung

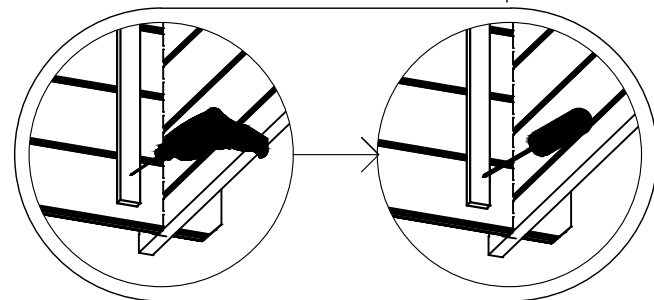
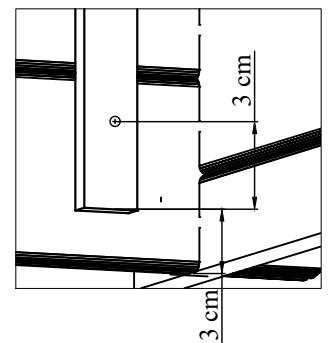
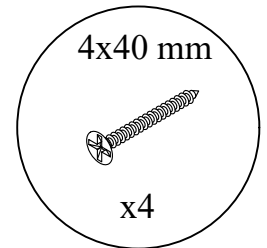
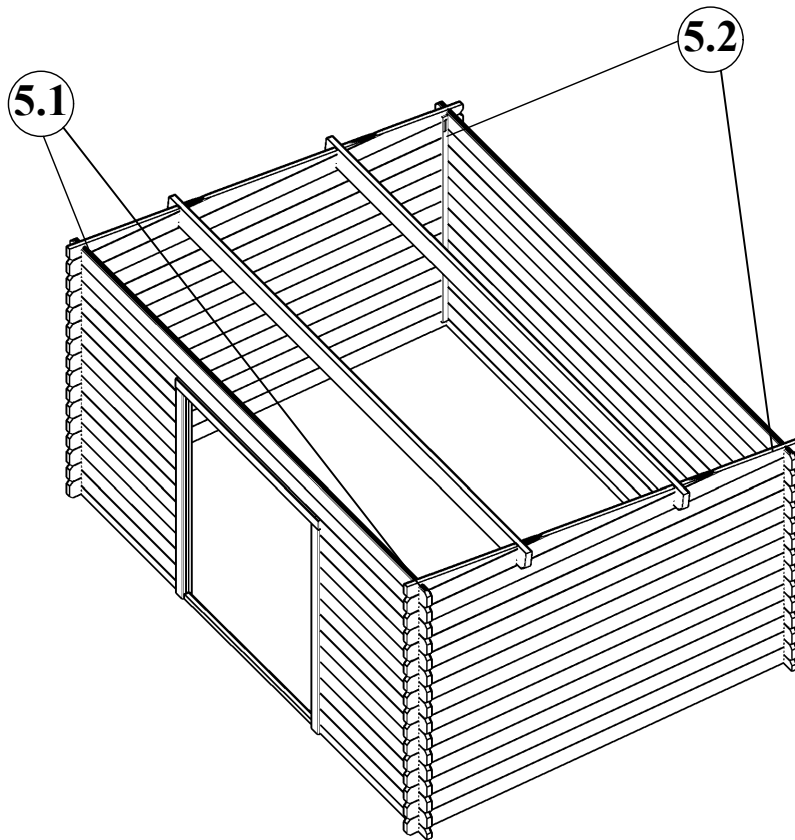
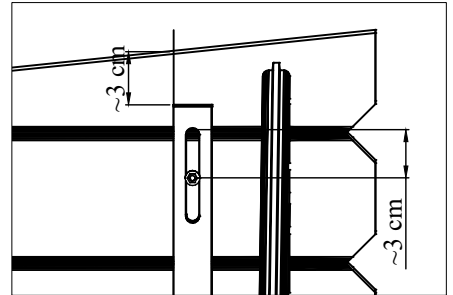
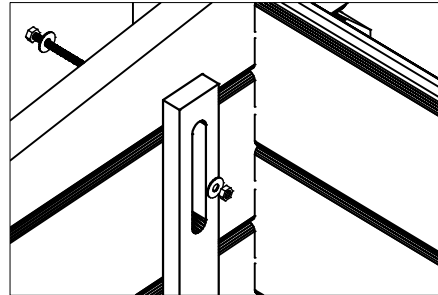
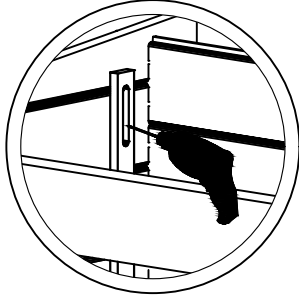
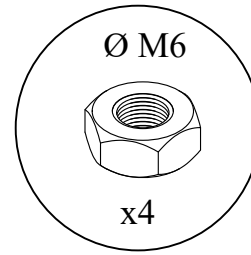
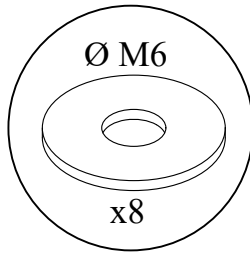
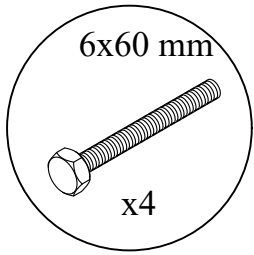

Pos.	Dimension (mm)	Menge.
5.1	1980 x 40 x 16	2
5.2	1870 x 40 x 16	2



# Montage der Dachbretter

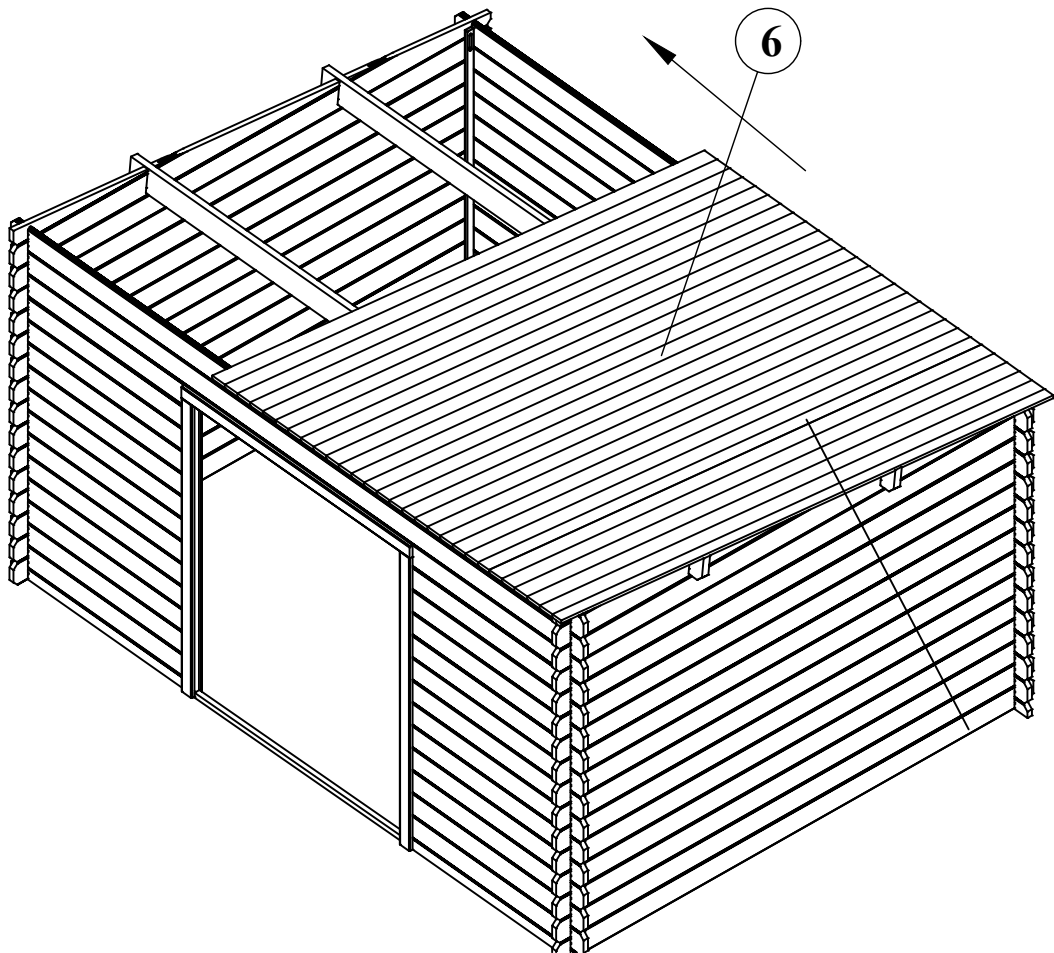
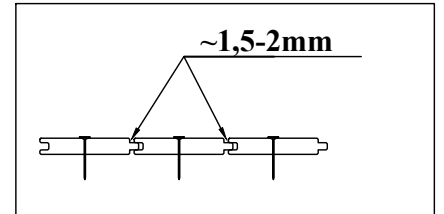
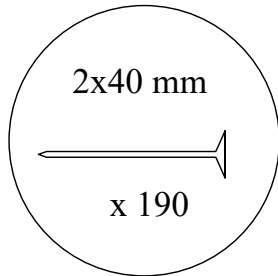
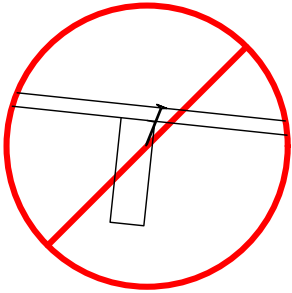
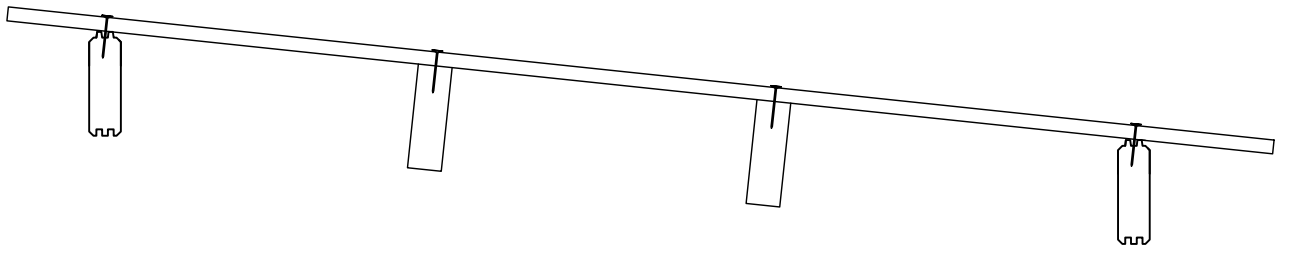

Pos.	Dimension (mm)	Menge.
6	2980 x 90 x 17	44+2

# Montage der Seitenbretter

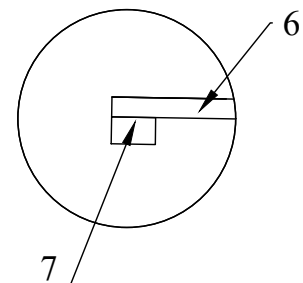
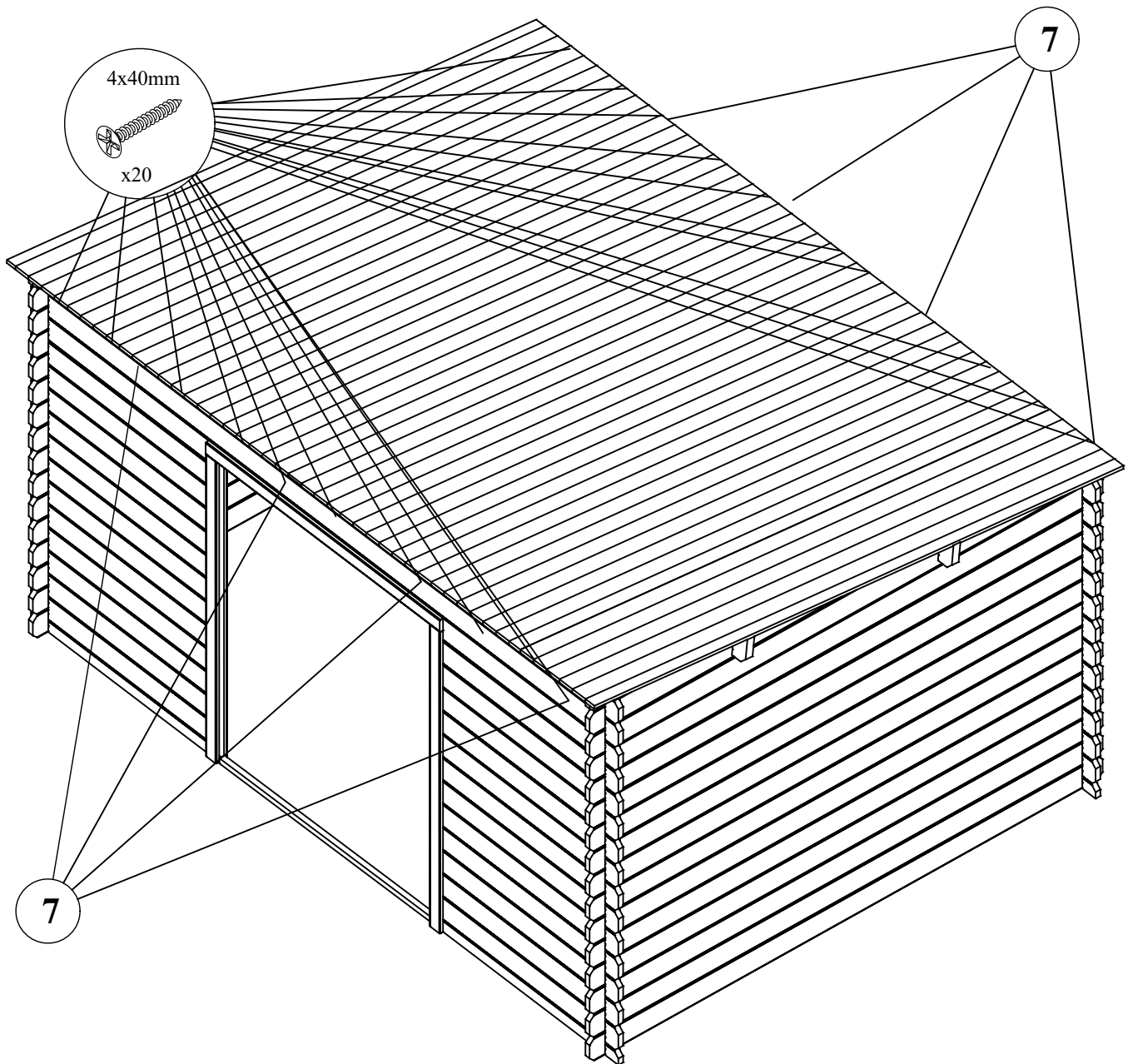

Pos.	Dimension (mm)	Menge.
7	1990 x 30 x 30	4

# Montage der Dachpappe

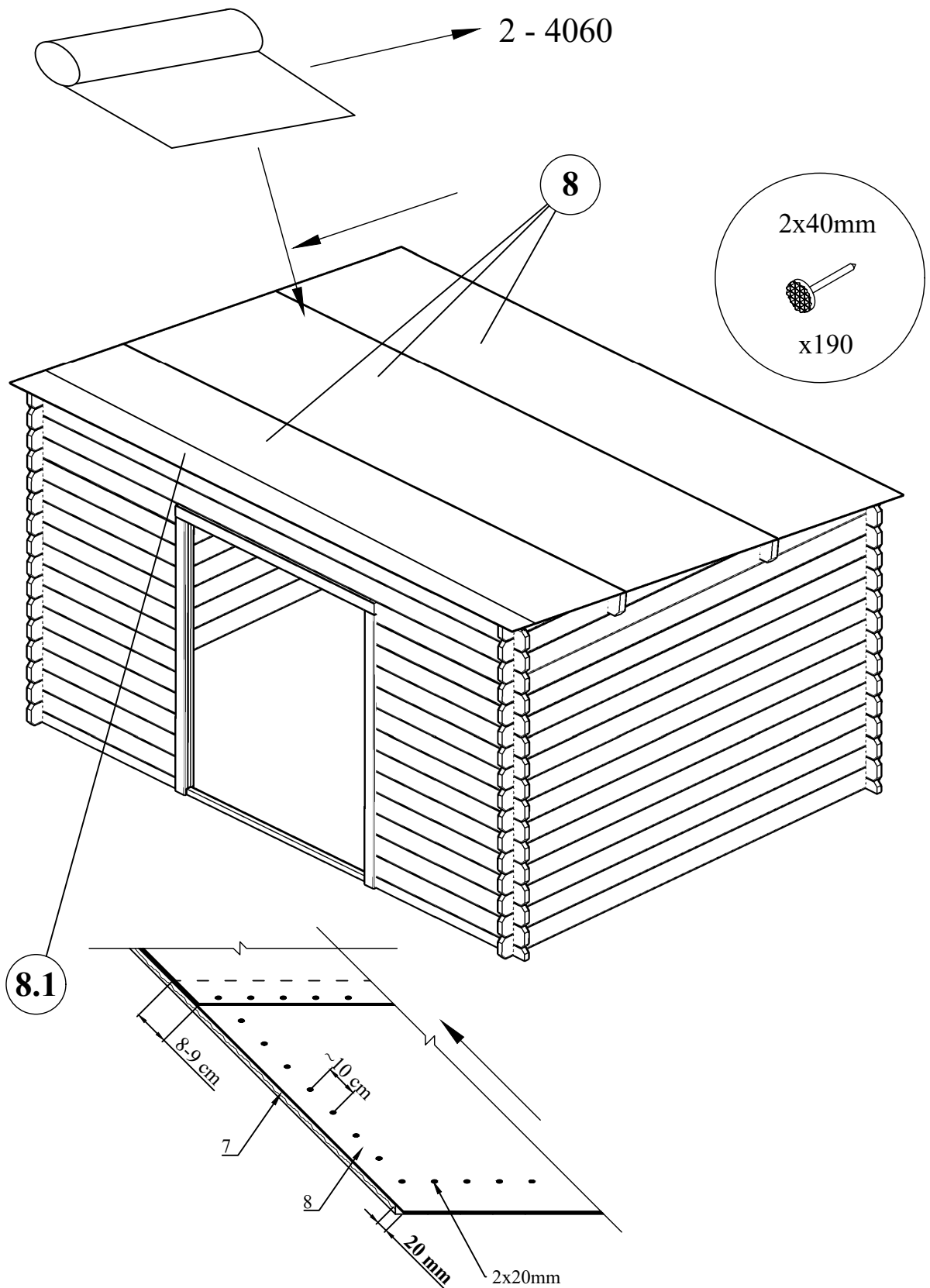

Pos.	Dimension (mm)	Menge.
8	4060 x 1000	3
8.1	4060 x 500	1

# Montage der Dachbretter

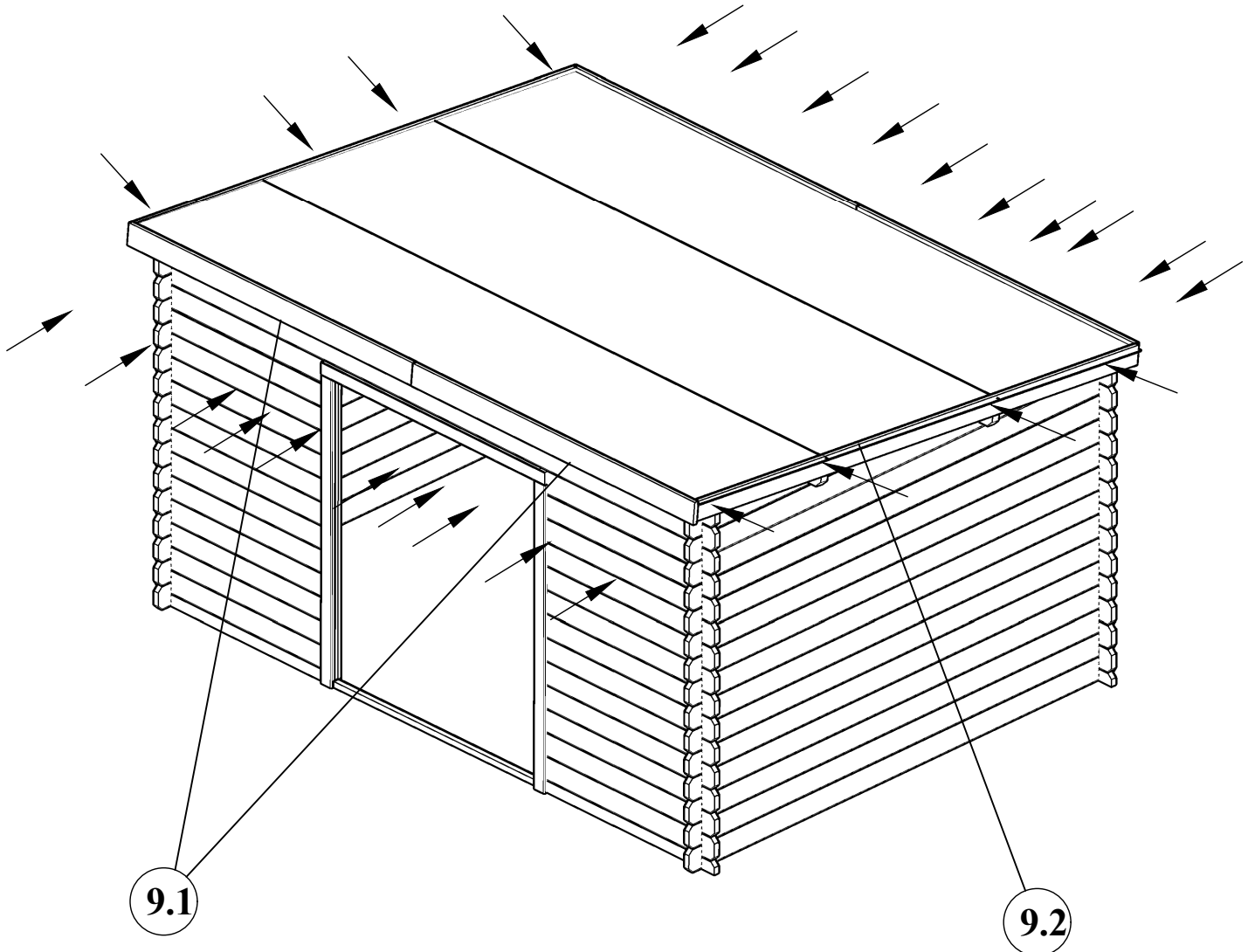
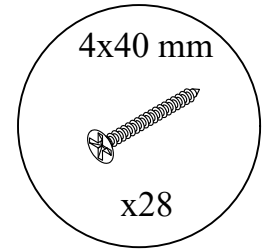

Pos.	Dimension (mm)	Menge.
9.1	2010 x 90 x 19	4
9.2	2980 x 90 x 19	2

# Montage der Tür

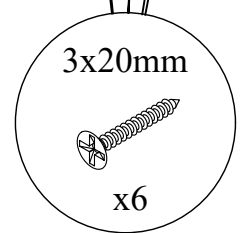
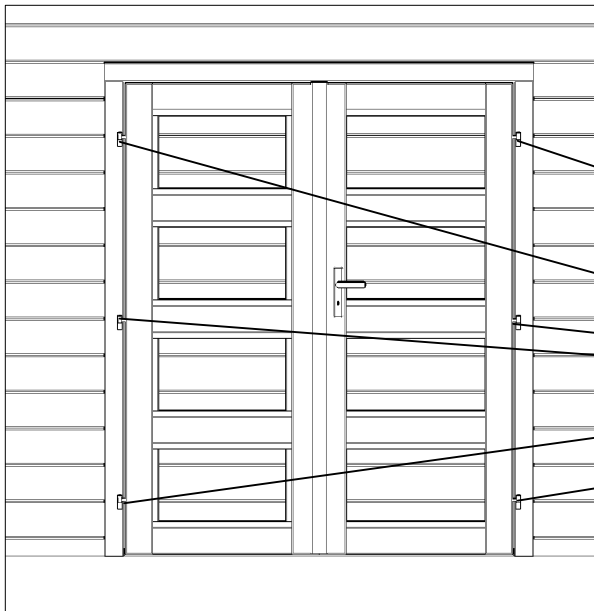
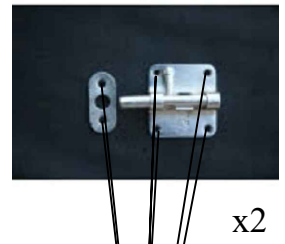
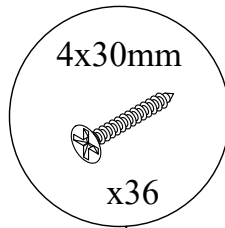
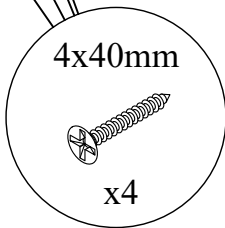
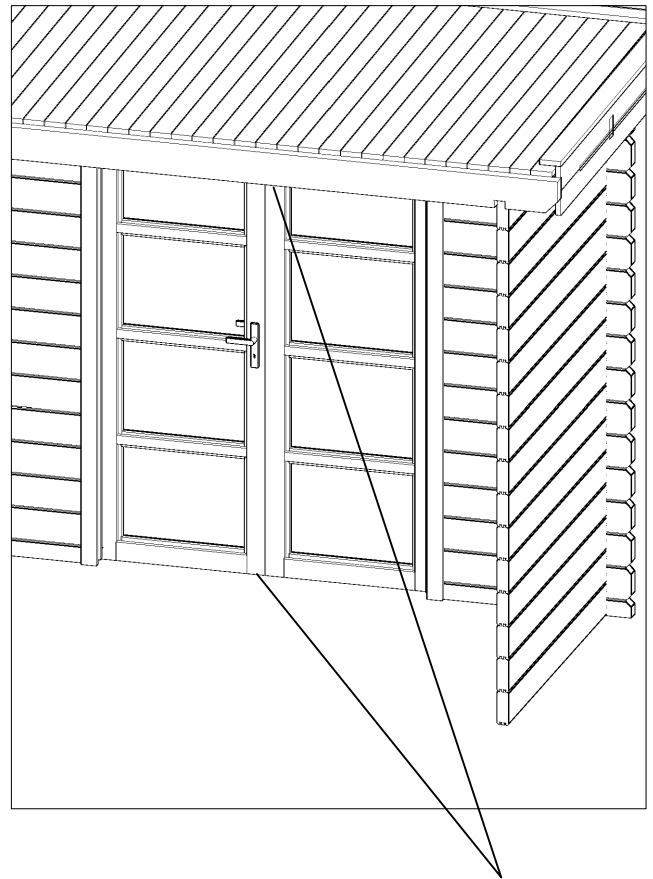
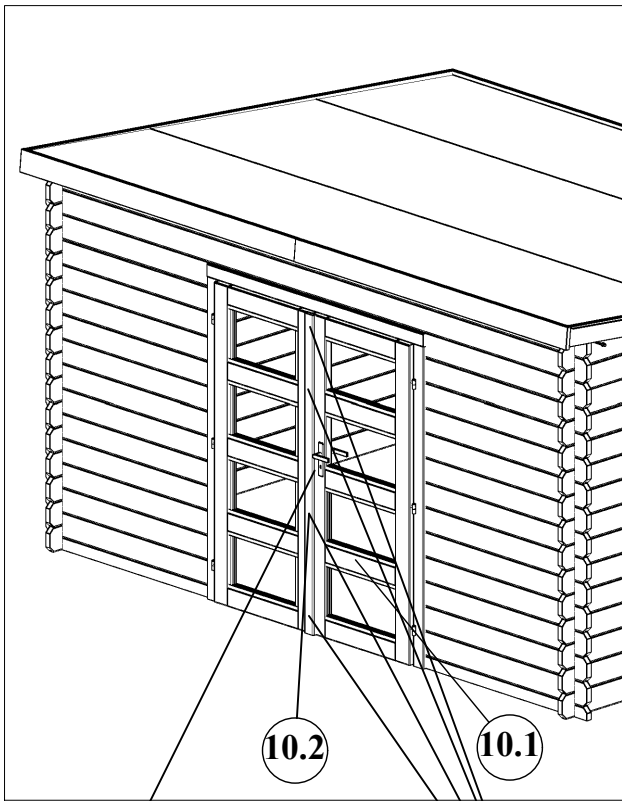

Pos.	Dimension (mm)	Menge.
10.1	1740 x 715	1 + 1
10.2	1740 x 75 x 19	2

# Justierung der Tür

