

Gewächshaus

Montageanleitung

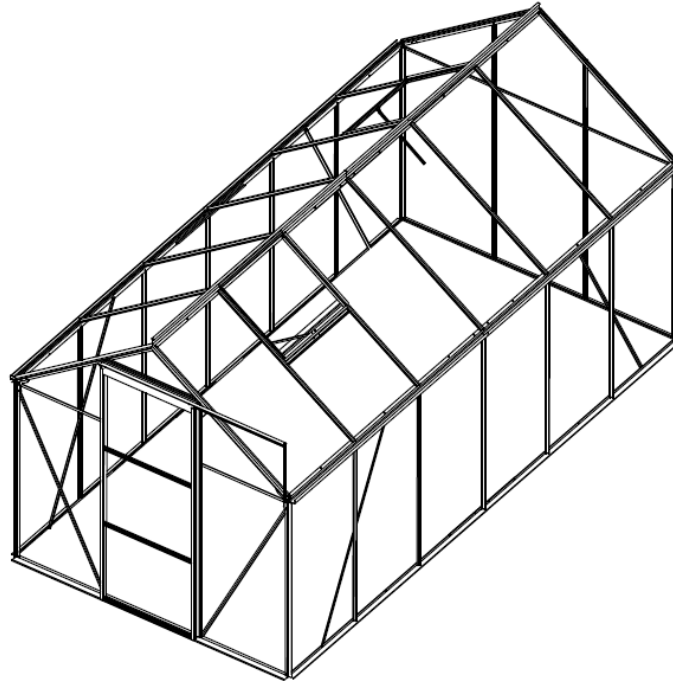

1900mm(L)x3700mm(W)x1950mm(H)

WICHTIG

Lesen Sie diese Anleitung vor dem Aufbau bitte vollständig durch, um Montagefehler oder Beschädigungen zu vermeiden.

Prüfen Sie bitte anhand der Packliste, ob das Gerätehaus vollständig bei Ihnen angekommen ist.

Befolgen Sie die beschriebene Reihenfolge der Anleitung aus.

Ziehen Sie die Stufen im Gewächshaus erst fest, wenn Sie die Polykarbonatplatten fertig montiert haben.

Bewahren Sie die Anweisungen an einem sicheren Ort auf.

SICHERHEITSHINWEISE

Wir empfehlen dringend die Verwendung von Arbeitshandschuhen.

Vermeiden Sie, das Gewächshaus in windigem oder nassem Zustand zu montieren.

Berücksichtigen Sie mit Aluminiumprofilen nicht keine Freileitungen zu berühren.

Tragen Sie immer Schuhe und Schutzbrillen, wenn Sie mit extrudiertem Aluminium arbeiten.

Entsorgen Sie alle Plastiktüten sicher- halten Sie sie außerhalb der Reichweite von Kindern.

Das Gewächshaus muss auf einer flachen, ebenen Oberfläche positioniert und befestigt werden.

Verschieben und Lehnen Sie sich nicht während der Montage an das Gewächshaus.

Unterlassen Sie die Montage des Gewächshauses, wenn Sie müde sind, Drogen oder Alkohol eingenommen haben oder wenn Sie zu Schwindelanfällen neigen.

Wenn sie eine Trittleiter oder Elektrowerkzeuge verwenden, stellen Sie sicher, dass Sie die Sicherheitsempfehlungen des Herstellers befolgen.

Heiße Gegenstände, wie kürzlich verwendete Grills, Lötlampen usw. sollten nicht im Gewächshaus gelagert werden.

Stellen Sie sicher, dass keine verdeckten Rohre oder Kabel im Boden sind, bevor Sie die Dübel einsetzen.

Bewahren Sie alle kleinen Teile (Schrauben usw.) in einer Schüssel auf, damit sie nicht verloren gehen.

ALLGEMEINE HINWEISE

Es handelt sich um eine mehrteilige Baugruppe, daher wird die Montage mindestens 300 Minuten in Anspruch nehmen.

Wählen Sie eine sonnige, ebene Position und vermeiden Sie überhängende Bäume.

Wenn Sie ihr Gewächshaus direkt an einem festen Betonfundament befestigen, verwenden Sie die Löcher für die Vorbohrung auf der mitgelieferten Metallbasis.

Die Bauteile sollten in unmittelbarer Nähe überprüft und ausgelegt werden.

Beachten Sie, dass die Tür an der rechten Seite angebracht wird und sich somit nach rechts öffnet.

Halten Sie das Dach frei von Schnee und Laub.

PFLEGE UND WARTUNG























Wenn Ihr Gewächshaus gereinigt werden muss, verwenden Sie ein mildes Reinigungsmittel und verdünnen Sie es in Wasser.







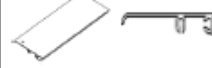

Verwenden sie KEINE Aceton-, Schleifmittel- oder sonstige Reinigungsmittel zur Reinigung der Klarsichtscheiben.









WERKZEUG UND AUSRÜSTUNG





Silikondichtungsmittel & Applikator, Bradawl Phillips Schraubenzieher, Leiter, Maßband, großer Hammer, Schere, Arbeitshandschuhe, Bohrmaschine, Wasserwaage, Schmiermittel für Kunststoff und Gummi.





Wenn Hilfe benötigt wird, wenden Sie sich an eine professionelle Beratung im Geschäft.

7		1215mm	4
16-1		1130mm	1
16-2			1
16-3			1
16-4			1
6		1830mm	1
5			1
4		1824mm	2
4-1			2
26		630mm	4
8		1824mm	2
8-1			2
17		1824mm	2
27		630mm	1
19		1215mm	10
20		1113mm	10
10R		1664mm	1
10L			1
9R		1641mm	1
9L			1
13		635mm	1
18		1245mm	1
25		396mm	1
14		1824mm	1
12		596mm	2
22		1362mm	4
23		1310mm	2
21		632mm	2
15		602mm	5
W1		590mm	2
W2		522mm	4
W3		590mm	2
D1		1614mm	1
D4			1
D2		621mm	1
D3			3









B3		176	
B4		2	
B5		4	
B6		1	
B8		2	
W4		2	
S3		4	
S4		8	
S7		2	

S6L		1	
S6R		1	
F1		10	
F2		1	
F3		1	
F4		135	
F5		3	
F8		2	
F9		2	

P8		17	
P9		10	
P10		2	
P4L		2	
P4R		2	

P6		1	
P7		1	
P2		2	
P1		3	

Schütz für die Basis->D-4

4	2x	
4-1	2x	
8	2x	
8-1	2x	
26	4x	
17	2x	
27	1x	
F4	18x	

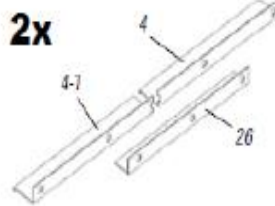



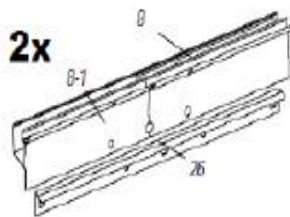

Schütz für die Traufe->D-8

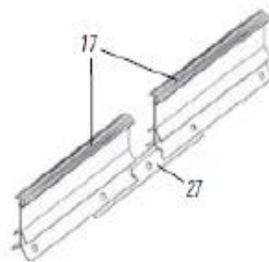







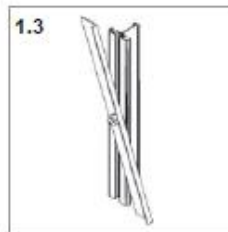
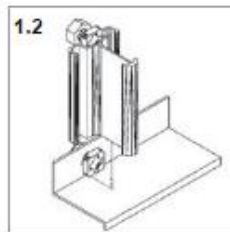
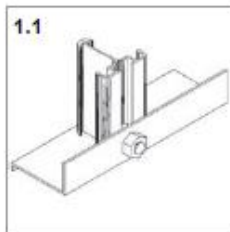
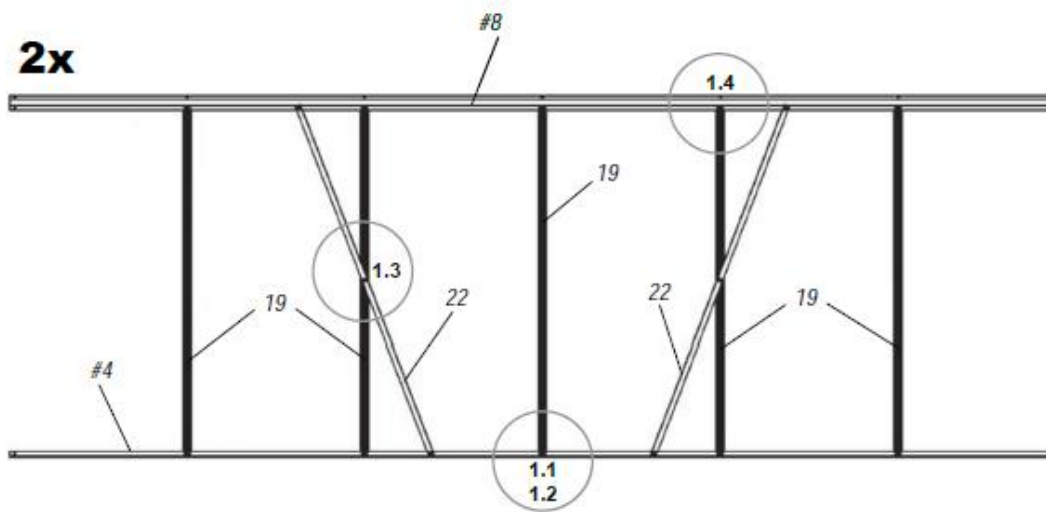

Schütz für das Dach->D-17



#4 2x	
#8 2x	
19 10x	
22 4x	
F4 32x	



7	2x	
16-3	1x	
16-4	1x	
5	1x	
10L	1x	
10R	1x	
14	1x	
B5	2x	
F4	16x	

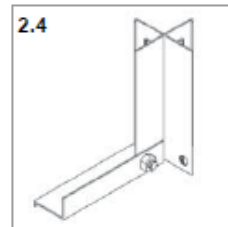
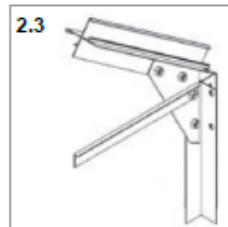
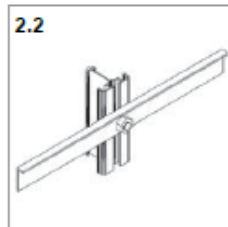
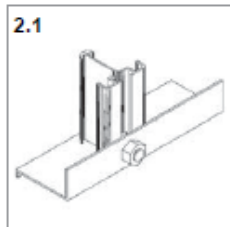
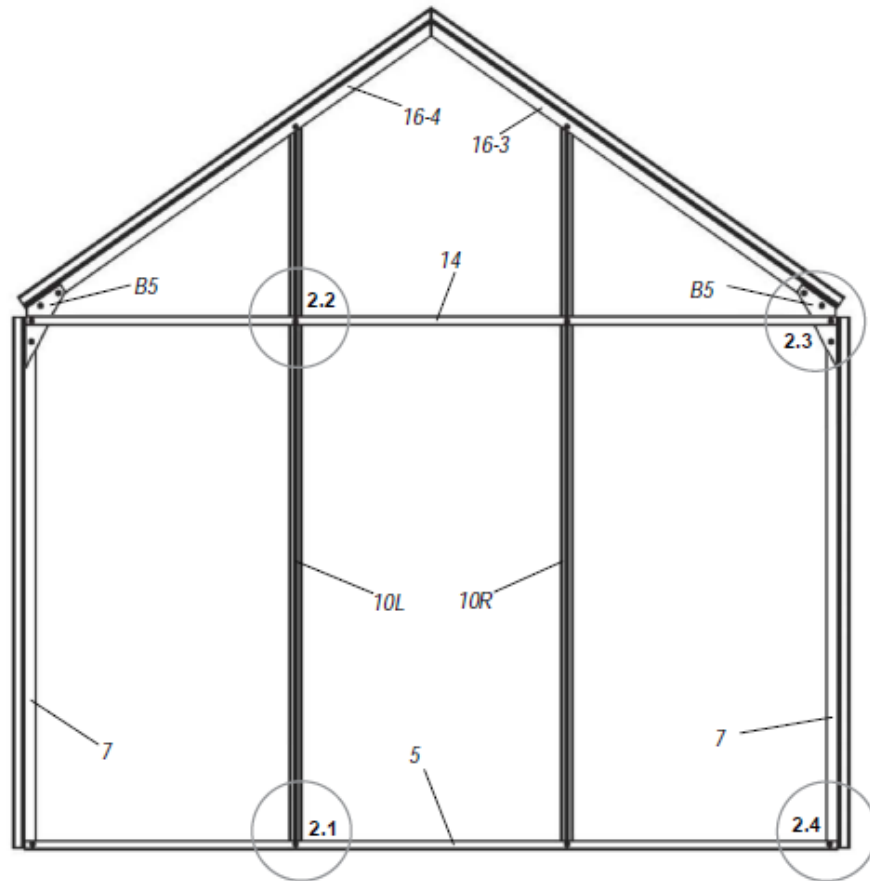

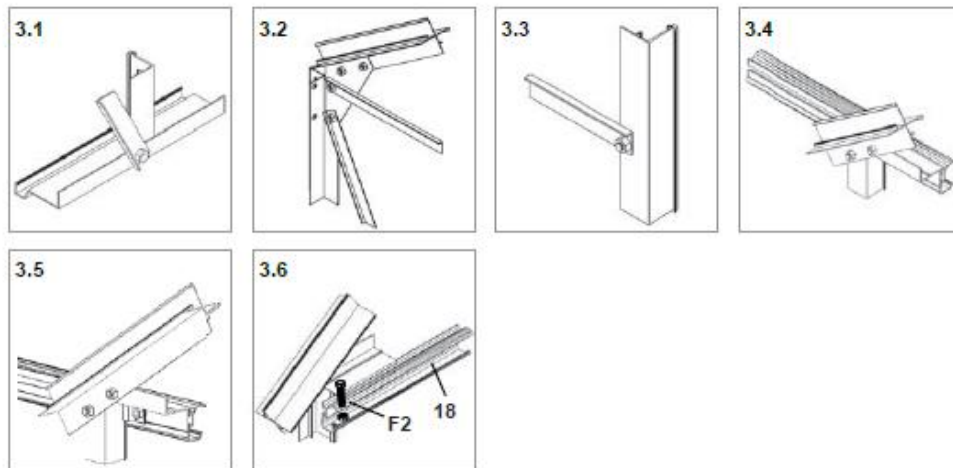
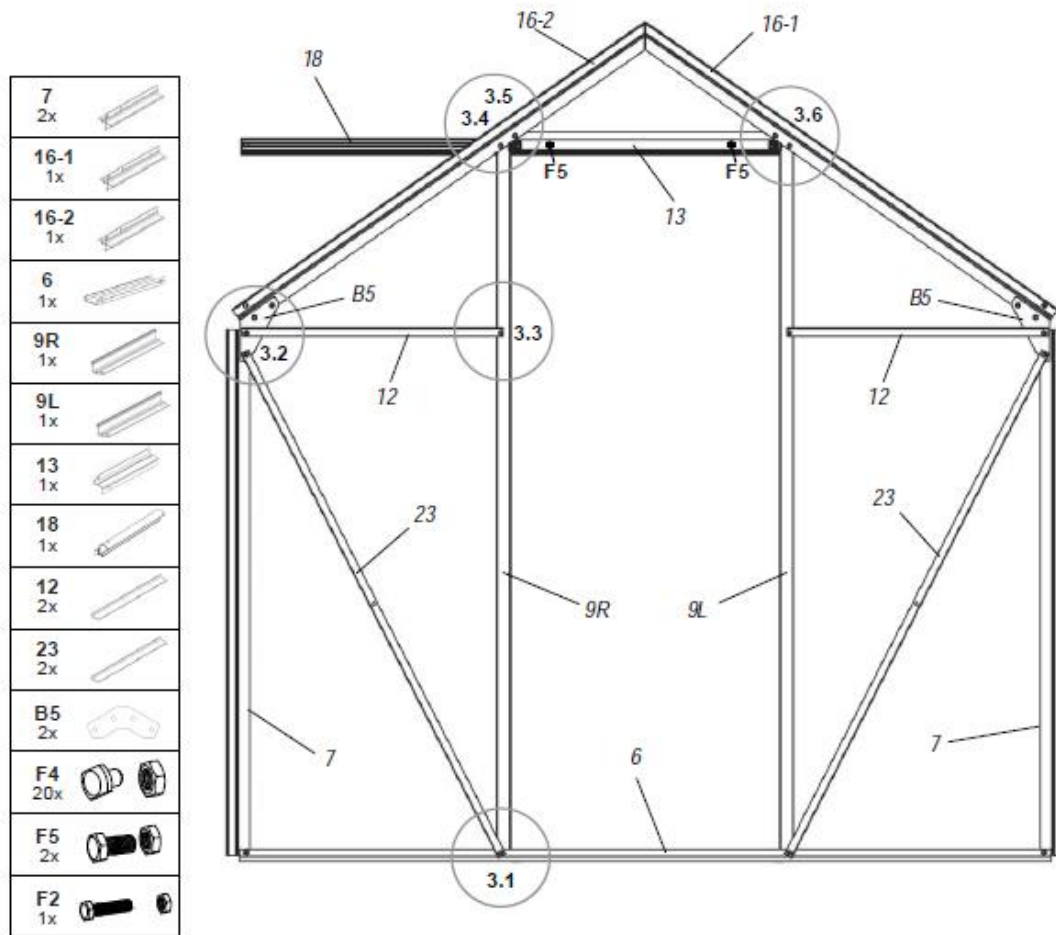

#17	1x	
20	10x	
25	1x	
F3	1x	
F4	37x	
F5	1x	
S3	4x	
S4	8x	

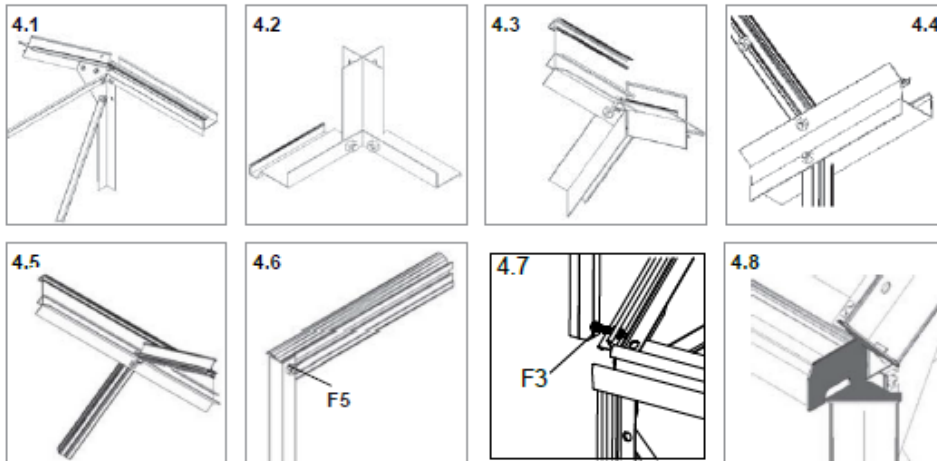
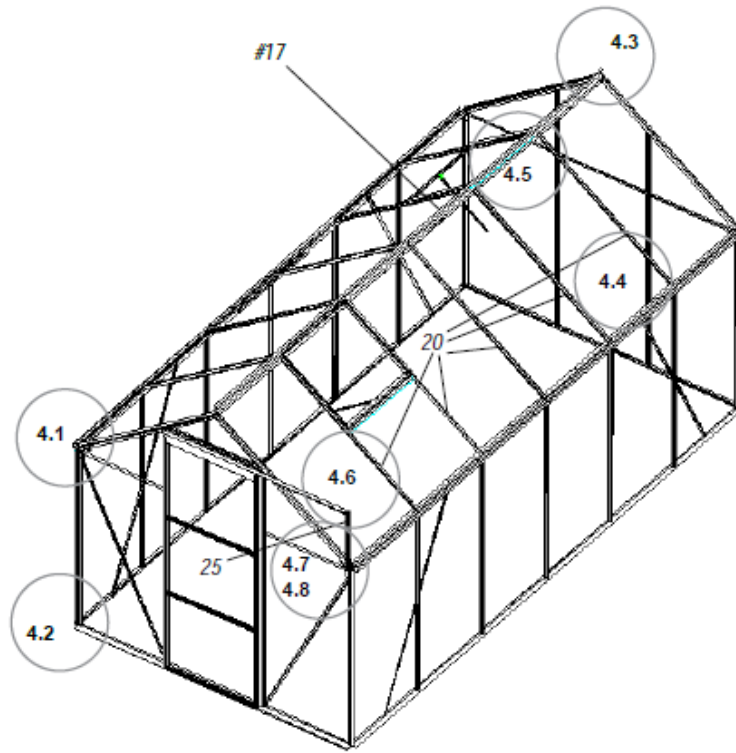

D1	1x	
D4	1x	
D2	1x	
D3	3x	
F1	10x	

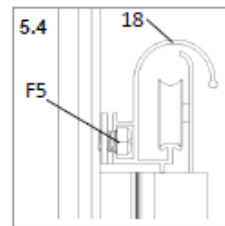
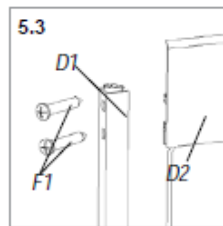
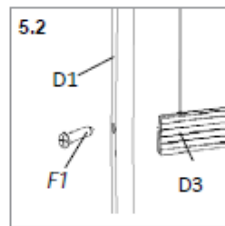
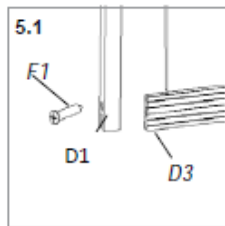
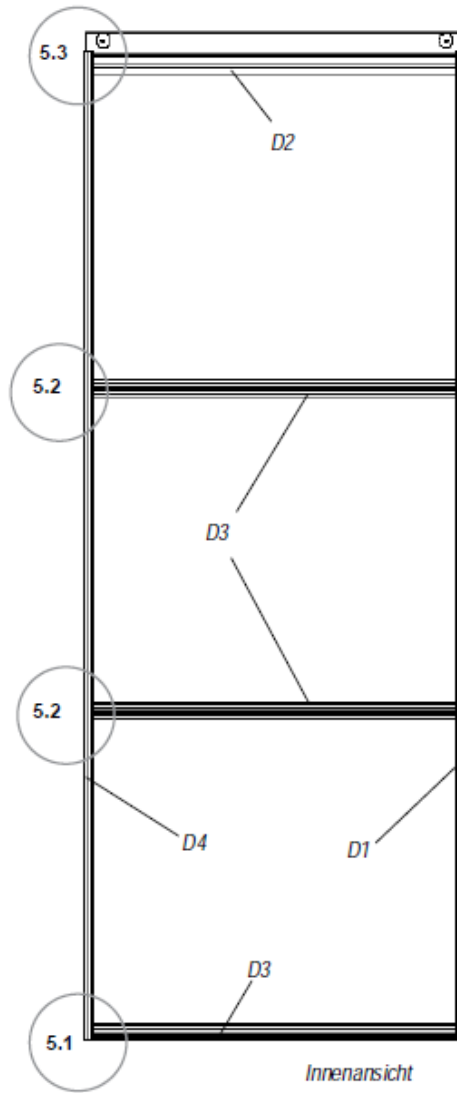

21	2x	
W1	2x	
W2	4x	
W3	2x	
B4	2x	
F4	16x	
W4	2x	
P2	2x	
B8	2x	
F8	2x	
F9	2x	

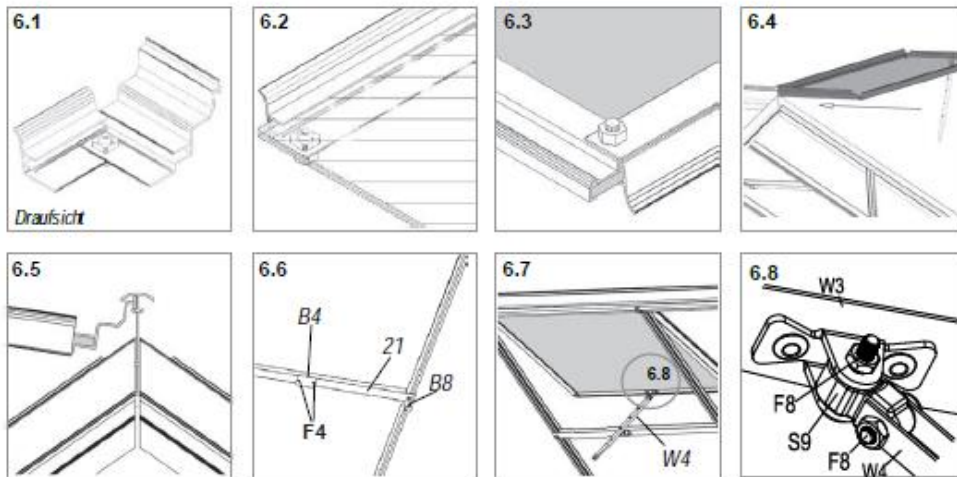
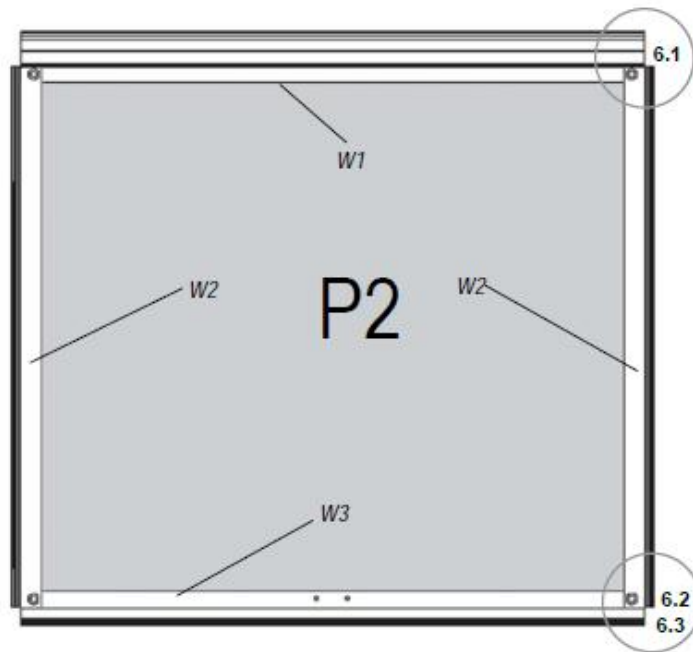

15 5x	
B3 176x	
P8 17x	
P9 10x	
P4L 2x	
P10 2x	
P6 1x	
P7 1x	
P4R 2x	
P1 3x	

